



**GRUPO ANBEC**

# CATÁLOGO 2019

 **ANBEC**<sup>®</sup>

**TRUEPOWER**<sup>®</sup>

 **SHUTZ**<sup>®</sup>

basic  
**BitKa**<sup>®</sup>

**MyPAT**  
cooler.

**STROM**

 **MASTERPROOF**<sup>®</sup>

# MISIÓN, VISIÓN Y VALORES

Nuestra filosofía de trabajo nos compromete a ser una compañía que aporta valor a sus clientes, proveedores y socios.

**GRUPO ANBEC** es: la pasión en lo que hacemos, la innovación que forma parte del día a día, la honestidad con la que trabajamos con nuestros clientes y socios comerciales, el respeto que tenemos por nuestra gente, la responsabilidad con la que nos conducimos, así como el trabajo en equipo; todo esto conformando nuestros valores esenciales y la base de nuestro crecimiento presente y futuro.

## ¿QUIÉNES SOMOS?

Durante más de 30 años nos enfocamos a ofrecer una amplia variedad de productos ferreteros de calidad, entregando en el menor tiempo posible.

Contamos con más de **4,500** productos, lo que nos consolida como una empresa líder dentro de la industria ferretera en México, con el principal objetivo de comprender las necesidades comerciales de nuestros clientes y empoderarlas para ayudarlos a lograr sus propósitos.

## COMPETITIVIDAD

Nuestros clientes continúan regresando porque **ANBEC**:  
Mantiene un alto nivel de servicio; se compromete a reducir el tiempo del ciclo, a optimizar los recursos, mejorar la velocidad de comercialización, aumentar la productividad de los empleados y reducir los errores.

# CAPACIDAD DE CARGA

**GRUPO ANBEC** cuenta actualmente con una infraestructura eficaz, dando soporte en toda la República Mexicana, Centro y Sudamérica del mercado ferretero y home center, contando con una extensa flotilla y un excelente personal calificado, desde choferes de reparto, ventas y ayudantes. Nos aseguramos que el soporte y servicio en cada una de las poblaciones del país sea de gran calidad, logrando que día a día se entregue cada orden y pedido a todos nuestros clientes que depositan su confianza en **GRUPO ANBEC**.

## POLÍTICA DE CALIDAD

Nuestra política de calidad es: Ofrecer a nuestros clientes una amplia variedad de productos ferreteros de calidad, entregando en el menor tiempo posible. Nos esforzamos en agregar valor en cada contacto con nuestros clientes al mejorar los requerimientos y resultados continuamente.

## IMPACTO

A través de la filosofía “Ganar- Ganar” **GRUPO ANBEC** siempre está abierto a consolidar nuevas alianzas, asociados y socios comerciales, rompiendo barreras, abriendo nuevos mercados, marcando la diferencia y generando un mayor impacto económico para cada uno de sus grupos de interés. Póngase en contacto hoy para saber cómo podemos trabajar juntos para hacer una diferencia en su negocio.

Todos los días trabajamos en mejorar nuestra propuesta de productos, buscando generar una mayor rentabilidad a nuestros clientes. Actualmente contamos con las siguientes 7 marcas:

 **ANBEC**<sup>®</sup>

La marca ANBEC es una de las marcas líderes en el segmento de plomería, con más de 1800 productos. Siendo una de las marcas más importantes de México, el programa ofrece productos para las categorías de mezcladoras, tarjas, llaves de baño, regaderas, mangueras, conexiones para gas, tubería y conexiones CPVC, tubería y conexiones PPR, accesorios varios, pegamentos para PVC y CPVC, muebles para baño, ovalines y muchos productos más.



**TRUEPOWER**<sup>®</sup>

Más de 1000 productos en herramientas que incluyen herramientas de mano, herramienta para el constructor, herramienta para el mecánico, soldadoras, compresores, equipo de seguridad, accesorios para pintar, herramientas de corte, escaleras, pintura en aerosol, lijas, entre otros.



 **SHUTZ**<sup>®</sup>

Una gama muy extensa en herrajes, cerraduras y bisagras; todo un programa que garantiza seguridad, durabilidad y calidad. El programa de SHUTZ incluye cerraduras, candados, jaladeras para muebles, bisagras, tornillos, clavos, pistones y rieles, entre otros productos.



basic  
**BitKa**<sup>®</sup>

La línea de productos para el mercado de consumo a un precio muy competitivo, abarca productos de plomería, cerraduras, productos eléctricos, y más.



**MyPAT**  
cooler<sup>®</sup>

La línea de productos de temporada de verano para aires lavados y acondicionados. MyPAT COOLER incluye bombas, motores, controles, conexiones, poleas, accesorios y refacciones para los aparatos de aire.



**STROM**<sup>®</sup>

La opción en productos eléctricos e iluminación: focos Led, focos ahorradores, extensiones, interruptores, apagadores, tomacorrientes, probadores, multímetros, linternas de mano, antenas para TV, accesorios para audio, y más.

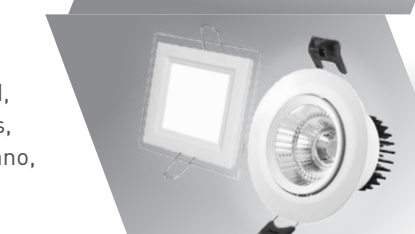

 **MASTERPROOF**<sup>®</sup>

Todo un programa de productos, que incluye impermeabilizantes, cementos plásticos, adhesivos para tablaroca, pegamentos para PVC y CPVC, pegamentos para madera blancos y amarillos, selladores para piso, y muchos más.



# ESQUEMA DE CONTENIDO

Nombre del producto

**Mezcladora fregadero**

Características importantes

Cuerpo de latón

Cuello tipo ganso

Características generales

Cubierta de ABS

Manerales de ABS

Fotografía del producto



Iconografía general



Tabla de datos

CÓDIGO	DESCRIPCIÓN	PRECIO	INNER	MASTER
MEZF8012	Cromado	\$275.00	1	20

## Despachador de papel para WC

28.2 x 12 x 26.5 cm

Jumbo



Incluye: Llave para cubierta

Medidas en orden X, Y, Z

Accesorios que incluye

Cuerpo de plástico

La descripción puede variar según el producto en medidas, tamaños, colores, acabados, etc.



Empotrable



Incluye: taquetes y tornillos



Caja Etiqueta

Tipo de empaque

CÓDIGO	DESCRIPCIÓN	PRECIO	INNER	MASTER
DPB401	Blanco	\$340.00	1	12

## Extensión eléctrica

Uso rudo



Norma que cumple

Normas generales



Producto nuevo / mejorado



Iconografía conforme el producto

**CC3100**

Recuadro azul significa nueva medida de producto existente



CLAVIJA ATERRIZADA



CONTACTO ATERRIZADO



Calibre 16



Tarjeta

Voltaje  
Frecuencia  
Amperaje



**CC3100**  
**CC3100**  
**CC3100**

PRECIO MEJORADO

Color distintivo de la marca

Los precios mostrados no incluyen I.V.A.

CÓDIGO	DESCRIPCIÓN	PRECIO	INNER	MASTER
TPEC25163UL	25 ft (7.5 m)	\$ 280.00	1	24
TPEC50163UL	50 ft (15 m)	\$ 480.00	1	12
TPEC100163UL	100 ft (30 m)	\$ 990.00	1	6



Caja a color



Caja Etiqueta



Caja Impresora



Caja Ventana



Etiqueta



Tarjeta



Bolsa etiqueta



Bolsa cabezal



Bolsa impresora



Bolsa tarjeta



Blister



Blister doble



Holder etiqueta



Cabezal



Contenedor etiqueta



Contenedor / Estuche

ÍCONOS DE EMPAQUES

El aspecto, empaque, inner o master de los productos puede variar sin previo aviso debido a la innovación continua de nuestras marcas.

# ÍNDICE ALFABÉTICO



<b>A</b>		CODOS, PPR	108	<b>F</b>	
ABRAZADERAS	106	COLADERAS	88	FILTROS ATRAPA PELUSAS	93
ABRAZADERAS PARA DUCTO DE ALUMINIO	92	COMBOS PARA LAVABO	17, 69	FILTROS PARA AGUA	39
ADAPTADORES DE COBRE	103	CONECTOR CÉSPOL	92	FLOTADORES PARA SANITARIO	85
ADAPTADORES PARA FILTRO	39	CONECTOR PARA LAVADORA	122	FLUXÓMETROS PARA MINGITORIO	97
ADAPTADORES, CPVC	110	CONECTOR UNIVERSAL	85	FLUXÓMETROS PARA SANITARIO	97
ADAPTADORES, PPR	109	CONECTORES PARA FILTRO	39	<b>G</b>	
AIREADORES	37	CONECTORES, PVC	19	GANCHO TRIPLE	79
ALIMENTADORES PARA BOILER	122	CONECTORES, COBRE	103	GARZA PARA FILTRO	39
ALIMENTADORES PARA GAS	123	CONECTORES, CPVC	110	GARZAS PARA MEZCLADORA, MONOMANDO	36
ALIMENTADORES PARA LAVABO / FREGADERO	121	CONECTORES, LATÓN	100	GARZAS PARA MEZCLADORA, FREGADERO	37
ALIMENTADORES PARA SANITARIO	121	CONECTORES, PPR	108	GARZAS PARA MEZCLADORA, LAVABO	37
ASIENTOS PARA INODORO	18, 86	CONTRACANASTAS PARA FREGADERO	35	GRAPAS, CPVC	110
<b>B</b>		CONTRAS PARA LAVABO	90	<b>H</b>	
BARRAS DE SEGURIDAD PARA BAÑO	78	COPLÉ DRESSER	99	HERRAJES PARA TINA	34
BOILERS	107	COPLÉ DRESSER, PVC	113	<b>I</b>	
BOQUILLAS PARA TANQUE	105	COPLÉ UNIÓN	101	INODOROS	67
BOTÓN DUAL FLUSH PARA SANITARIO	85	COPLÉS, PVC	19	INODOROS  ELITE	14
BOTÓN PARA TINA	47	COPLÉS, CPVC	110	<b>J</b>	
BRAZOS CHAPETÓN	48	COPLÉS, PPR	108	JABONERAS	81
BRAZOS PARA REGADERA ELÉCTRICA	53	CRUZ, CPVC	111	JUEGO DE HERRAJES PARA INODORO	18
BRIDAS PARA CORTINERO	79	CUBIERTAS PARA MEZCLADORA	36	JUEGO DE LLAVES PARA EMPOTRAR, CPVC	112
<b>C</b>		CUBRETALADRO PARA FREGADERO	34	JUEGO DE LLAVES PARA EMPOTRAR, PPR	109
CAJA DE SALIDA PARA LAVADORA	93	CUELLOS PARA SANITARIO	87	JUEGO DE SOPORTES PARA MEZCLADORA	36
CAJA EMPOTRABLE PARA REFRIGERADOR	93	<b>D</b>		JUEGOS DE ACCESORIOS PARA BAÑO	74
CALENTONES	107	DESAGÜES PARA TINA DE BAÑO	46	JUEGOS DE HERRAJES PARA SANITARIO	83
CARTUCHO PARA GAS	105	DESPACHADORES DE PAPEL, MANOS	82	<b>K</b>	
CARTUCHOS / VÁSTAGOS PARA MEZCLADORA	114	DESPACHADORES DE PAPEL, SANITARIO	82	KITS CPVC	19
CEDAZOS PARA CONTRACANASTA	35	DESTAPACAÑOS	85	KITS DE INSTALACIÓN PARA BOILER	124
CINTA SELLADORA, TEFLÓN	106	DESVIADOR PARA REGADERA TIPO TELÉFONO	53	KITS DE INSTALACIÓN PARA MEZCLADORA DE LAVABO	124
CEPILLEROS	81	DOSIFICADORES PARA JABÓN	79	KITS DE INSTALACIÓN PARA TARJA	124
CÉSPOL PARA FREGADERO	38	DUCTOS PARA FILTRO ATRAPA PELUSAS	93	KITS DE REGADERA	54
CÉSPOL PARA LAVABO / FREGADERO	91	<b>E</b>		KITS DE TERMOFUSIÓN	109
CHAPETONES PARA REGADERA	40	EMPAQUES	120	KITS PPR	19
CHAROLAS PARA CUBIERTOS	19	EMPAQUES PARA SANITARIO	85	<b>LL</b>	
CILINDROS PARA GAS	107	ENCENDEDOR DE PIEDRA AUTÓGENA	105	LLAVE DE PASO, CPVC	112
CINTA SELLADORA PARA SANITARIO	90	ENCENDEDORES	104	LLAVE INDIVIDUAL PARA LAVABO	95
CODO DE COBRE	103	ESPEJOS	80	LLAVE PARA MINGITORIO	97
CODOS, PVC	19	EXTENSIONES PARA FREGADERO	38	LLAVE PARA PORTAGARRAFÓN	39
CODOS, CPVC	110	EXTENSIONES PARA LAVABO	92	LLAVE PARA TINACO, CPVC	112
CODOS, LATÓN	102			LLAVES DE EMPOTRAR	44

# POR MARCAS

LLAVES DE JARDÍN	94	PORTA ROLLOS	81	TEE FLARE	100
LLAVES DE RETENCIÓN	96	PUNTA POOL DE REDUCCIÓN	104	TEE SOLDABLES	101
LLAVES DE RETENCIÓN, CPVC	112	PUNTAS POOL	101	TEE TERMINAL	100
LLAVES PARA BEBEDERO	97			TEE, CPVC	110
LLAVES PARA LAVADORA	98			TEE, PPR	108
<b>M</b>		<b>Q</b>		TERMOCOPLE PARA GAS	104
MANERAL PARA LLAVE DE JARDÍN	94	QUEMADORES PARA GAS	105	TERMOPAR	104
MANERALES	40	<b>R</b>		TERMOSTATO AUTOMÁTICO	104
MANGUERA DE DESAGÜE	122	REDUCCION BUSHING	103	TOALLEROS	81
MANGUERA PARA GAS NATURAL	123	REDUCCIÓN BUSHING, CPVC	111	TUBOS PARA FREGADERO	38
MANGUERAS PARA MEZCLADORA	36	REDUCCIÓN CAMPANA, CPVC	110	TUBOS, PVC	19
MANGUERAS PARA MEZCLADORA, MONOMANDO	36	REGADERAS	49	TUBOS, CPVC	113
MANIVELAS PARA SANITARIO	85	REGADERAS ELÉCTRICAS	53	TUBOS, PPR	109
MEZCLADORAS FREGADERO, MONOMANDO	25	REGADERAS MASAJE	54	TUERCA MACHO	101
MEZCLADORAS FREGADERO, TIPO BASTÓN	22	REGADERAS TIPO TELÉFONO	54	TUERCA UNIÓN, COBRE	103
MEZCLADORAS FREGADERO, TIPO COBRA	21	REGULADOR CON MANGUERA	123	TUERCAS PARA CONTRACANASTA	35
MEZCLADORAS FREGADERO, TIPO GANSO	20	REGULADORES PARA GAS	104	TUERCAS PARA GARZA	37
MEZCLADORAS LAVABO	55	REJILLAS PARA COLADERA	88	TUERCAS PARA CONTRACANASTA	35
MEZCLADORAS LAVABO, MONOMANDO	60, 64	REPISAS PARA BAÑO	78	TUERCAS, LATÓN	101
MEZCLADORAS LAVABO, TIPO BASTÓN	61	REPUESTOS PARA FILTRO	39	TUERCAS, PPR	108
MEZCLADORAS MONOMANDO PARA REGADERA	46	RESISTENCIAS PARA REGADERA ELÉCTRICA	53		
MEZCLADORAS PARA REGADERA	45	RESUMIDEROS	89	<b>V</b>	
MEZCLADORAS, COLOR NEGRO	18	ROCIADORES PARA MEZCLADORA	37	VÁLVULA DE PASO, CPVC	112
MINGITORIOS	67	<b>S</b>		VÁLVULA ESFERA, CPVC	112
MUEBLES PARA LAVABO	69	SAPITOS PARA SANITARIO	83	VÁLVULA PARA TANQUE DE GAS	105
<b>N</b>		SECADOR DE MANOS ELÉCTRICO	82	VÁLVULAS CHECK	99
NARIZ PARA TINA	47	SET DE MEZCLADORA MONOMANDO, REGADERA Y SALIDA TINA	47	VÁLVULAS DE BANQUETA	98
NIPLE CAMPANA	101	SET DE MEZCLADORA Y REGADERA	45	VÁLVULAS DE COMPUERTA	98
NIPLE PARA CALENTÓN	101	SET DE MEZCLADORA, REGADERA Y SALIDA TINA	45	VÁLVULAS DE ENTRADA PARA SANITARIO	84
NIPLE ROSCA	103	SOPLETES PARA GAS	104	VÁLVULAS DE PASO	98
NIPLE TERMINAL	101	SOPORTES PARA LAVABO	90	VÁLVULAS DE SALIDA PARA SANITARIO	83
NIPLES	101	<b>T</b>		VÁLVULAS DE SALIDA PARA SANITARIO, DOBLE ACCIÓN	84
<b>O</b>		TANQUE REPUESTO BERNZOMATIC	105	VÁLVULAS DE SEGURIDAD PARA BOILER	98
ORGANIZADORES PARA REGADERA	77	TAPAS DE FIERRO PARA TOMA DOMICILIARIA	99	VÁLVULAS ESFERA	98
OVALINES	68	TAPONES HEMBRA DE LATÓN	101	VÁLVULAS ESFERA, PVC	113
OVALINES <b>ANBEC</b>   ELITE	15	TAPONES PARA LAVABO	90	VÁLVULAS PARA GAS	100
OVALINES, BEIGE	17	TAPONES, PVC	19	VÁLVULAS PARA TANQUE ALTO	99
<b>P</b>		TAPONES, CPVC	111	VÁLVULAS, PPR	109
PICHANCHAS	99	TAPONES, PPR	108	VARILLA PARA FLOTADOR	85
PIGTAIL PARA GAS	123	TARJAS	29		
PIJAS PARA SANITARIO	87	TARJAS, EMPOTRAR	29		
		TARJAS, SOBREPONER	30		
		TARJAS, SUBMONTABLES	31		

# ÍNDICE ALFABÉTICO



<b>A</b>	
ALIMENTADORES FLEXIBLES, BOILER	135
ALIMENTADORES FLEXIBLES, LAVABO / FREGADOR	135
ALIMENTADORES FLEXIBLES, SANITARIO	135
<b>C</b>	
CARTUCHOS / VÁSTAGOS PARA MEZCLADORA	134
CERRADURAS, COMBOS	137
CERRADURAS, MANIJA	137
CERRADURAS, POMO	136
CERROJOS	137
<b>G</b>	
GARZAS FLEXIBLES	133
<b>LL</b>	
LLAVES DE JARDÍN	135
LLAVES DE RETENCIÓN	135
<b>M</b>	
MEZCLADORAS FREGADERO	129
MEZCLADORAS FREGADERO, CUELLO BASTÓN	130
MEZCLADORAS FREGADERO, CUELLO COBRA	129
MEZCLADORAS FREGADERO, CUELLO GANSO	129
MEZCLADORAS FREGADERO, GARZA FLEXIBLE	130
MEZCLADORAS LAVABO	131
MEZCLADORAS LAVABO, MONOMANDO	133
<b>R</b>	
REGADERAS	133

<b>A</b>	
ADDMIX, TRATAMIENTO PARA JUNTAS DE TABLAROCA	142
<b>B</b>	
BROCHA DE IXTLE	142
<b>C</b>	
CEMENTO CPVC	140
CEMENTO PLÁSTICO	140
CEMENTO PVC	140
CEMENTO PVC, EXTRA REFORZADO	140
CEMENTO, MULTIUSOS	140
CEPILLO	142
CONCRETE SEAL	140
<b>E</b>	
ESPUMA DE POLIURETANO	142
<b>I</b>	
IMPERMEABILIZANTE FIBRATADO	141
IMPERMEABILIZANTE, PREMIUM	141
IMPERMEABILIZANTE, REFORZADO DE CAUCHO	141
IMPERMEABILIZANTE, TERRACOTA	141
<b>L</b>	
LIMPIADOR, PVC, CPVC Y ABS	140
<b>P</b>	
PEGAMENTO AMARILLO	142
PEGAMENTO BLANCO	142
PEGAMENTO CLAVO LÍQUIDO POWER NAIL	139
PINZA PARA CUBETA	142
<b>S</b>	
SELLADORES	139
SILICONES	139
<b>T</b>	
TEFLÓN LÍQUIDO	140

<b>A</b>	
ACEITE LUBRICANTE PARA AIRE	148
ÁNODOS DE MAGNESIO ANTISARRO	147
<b>B</b>	
BANDAS V PARA AIRE	148
BASE PARA MOTOR	146
BOMBAS PARA ENFRIADORES	146
BOMBAS SUMERGIBLES PARA ENFRIADOR	145
<b>C</b>	
CEDAZOS PARA AIRE	147
CHUMACERAS	147
CODO COMPRESIÓN PARA POLIDUCTO	149
CONTROL PARA AIRE ACONDICIONADO	146
<b>D</b>	
DISTRIBUIDOR PARA AIRE	148
DREEN PARA AIRE	149
<b>E</b>	
ELIMINADOR DE SALES PARA AIRE	148
<b>F</b>	
FLOTADORES PARA AIRE	146
<b>G</b>	
GARBANZOS	149
<b>I</b>	
IMPERMEABILIZANTE PARA AIRE	148
<b>M</b>	
MOTOR PARA AIRE	146
<b>N</b>	
NIPLES	149
<b>P</b>	
PASTILLA DESODORANTE PARA AIRE	148
POLEAS	147
<b>R</b>	
ROLLO POLIDUCTO	148
<b>S</b>	
SELLADOR PARA AIRE EVAPORATIVO	148
<b>T</b>	
TEE COMPRESIÓN PARA POLIDUCTO	149
TUERCA PARA POLIDUCTO	149
<b>V</b>	
VÁLVULA	147
VÁLVULA SILLETA	147
VENTILADOR DE TECHO	145







<b>A</b>	
ALDABAS	193
ALMOHADILLAS ANTIDESLIZANTES	168
ALMOHADILLAS DE FELPA	168
ALMOHADILLAS TRANSPARENTES	168
AMORTIGUADORES PARA MUEBLE	189
ARMELLAS	193
<b>B</b>	
BASES PARA MUEBLE	168
BISAGRAS	184
BISAGRAS PARA PUERTA, BOBLE ACCIÓN	187
BISAGRAS PARA PUERTA, TIPO LIBRO	186
BISAGRAS PLANAS PARA COCINA	187
BISAGRAS, CIERRE LENTO	185
BISAGRAS, OCULTAS	184
BISAGRAS, PUENTE	185
BISAGRAS, TIPO AVIÓN	185
BOTELLEROS	189
BOTONES	151, 174
BRIDAS PARA TUBO DE CLÓSET	164
<b>C</b>	
CANDADOS	170
CANDADOS, ALTA SEGURIDAD	172
CANDADOS, BICICLETA	173
CERRADURA MAGNÉTICA	164
CERRADURA PARA VENTANA	153, 162
CERRADURA, ELÉCTRICA	160
CERRADURAS PARA CAJÓN	161
CERRADURAS PARA CLOSET	161
CERRADURAS PARA MUEBLE	161
CERRADURAS, MANIJA	151, 156
CERRADURAS, POMO	156
CERRADURAS, PUERTA PRINCIPAL	153
CERRADURAS, SOBREPONER	160
CERROJOS	151, 157
CERROJOS ELÉCTRICOS	151
CESTO CON RIEL	189
COMBOS CERRADURAS PARA EMBUTIR	157
COMBOS CERRADURAS Y CERROJOS	151, 158
<b>D</b>	
DADO MAGNÉTICO	193
<b>E</b>	
EMBELLECEDORES	193
<b>G</b>	
GANCHOS	165
<b>I</b>	
INSERTOS	193
<b>J</b>	
JALADERAS	151, 177
JUEGO DE SUJECIÓN	193

<b>M</b>	
MIRILLA PARA PUERTA PRINCIPAL	163
<b>N</b>	
NÚMEROS DE CASA	153, 165
<b>P</b>	
PASACABLES	194
PASADORES PARA PORTÓN	162
PASADORES PARA PUERTA	153, 162
PATAS PARA MUEBLE	166
PERFILES DE JALADERAS DE ALUMINIO	177
PERICOS PARA PUERTA	164
PIJAS	190
PISTON ELEVABLE	189
PORTACANDADOS	162
PORTAGARRAFÓN	189
PROTECTOR PARA BANCO	168
<b>R</b>	
REGATÓN REDONDO	168
RIELES, CORREDERAS DE EXTENSIÓN	188
RODAJAS	194
RONDANAS	190
<b>S</b>	
SEPARADOR PARA CRISTAL	152
SOPORTE COMPÁS	189
SOPORTE PARA CLÓSET	164
SOPORTE PARA PASAMANOS	163
SOPORTES PARA REPISA	152
<b>T</b>	
TAQUETES	193
TAQUETES PARA TABLAROCA	193
TAQUETES, ANCLA	193
TOPES PARA PUERTA	152
TOPES PARA PUERTA	163
TORNILLO SUJETADOR, MARIPOSA	193
TORNILLOS	190
TUBOS PARA CLÓSET	164

<b>A</b>	
ACEITERAS	223
ADAPTADOR REDUCTOR	241
AGUJAS PARA INFLAR BALONES	202
ALAMBRE GALVANIZADO	251
ANCLA DE CONEXIÓN	231
ARCOS PARA SEGUETAS	219
ARNESES	231
ASPERORES PARA RIEGO	260
ATOMIZADORES	262
AZADONES	250
<b>B</b>	
BANDOLAS	229
BARRAS DE SILICÓN	255
BARRETA DE UÑA	213
BIELDOS	250
BOLA JALÓN PARA REMOLQUE	267
BOMBAS DE AIRE	203
BOMBAS EXTRACTORAS DE LÍQUIDOS	223
BOMBAS FUMIGADORAS	262
BOMBAS PARA AGUA	264
BOMBAS, TIPO JET	264
BOQUILLA PARA INYECTOR DE GRASA	223
BOTAS DE JARDÍN	231
BOTAS SANITARIAS	231
BOTES PARA PISTOLA DE PINTAR	201
BROCAS	216
BROCAS DE ALTA VELOCIDAD PARA METAL	245
BROCAS PARA CONCRETO	245
BROCAS PARA CONCRETO SDS PRO	244
BROCAS PARA METAL DE ACERO HSS	245
BROCAS PARA VIDRIO	216
BROCAS, MANITA	216
BROCHAS	257
<b>C</b>	
CABLE DE POSICIONAMIENTO	231
CABLE DESTAPADOR DE CAÑOS	223
CABLES PARA SOLDAR	208
CABLES PASA CORRIENTE	267
CADENA GALVANIZADA	228
CADENA PLÁSTICA	228
CADENA TIPO VICTOR	228
CADENAS PARA PERRO	228
CAJA PARA HERRAMIENTAS	242
CALIBRADOR VERNIER	212
CÁMARA PARA LLANTA, BICICLETA	203
CÁMARA PARA LLANTA, NEUMÁTICA	205
CANDADOS PARA VOLANTE	266
CARDAS	221



# ÍNDICE ALFABÉTICO

CARETA ELECTRÓNICA PARA SOLDAR	208	CUCHILLA REPUESTO PARA CORTAPERNO	253	GARRUCHA PARA NORIA	228
CARETA PARA SOLDAR	208	CUCHILLAS PARA CORTADORA DE AZULEJO	219	GATO PATÍN	267
CARETA PROTECTORA	232	CUTTERS / NAVAJAS	218	GOOGLES DE SEGURIDAD	232
CARRETIILLAS	205	<b>D</b>		GRAPAS PARA ALAMBRE	251
CASCO DE SEGURIDAD	232	DESARMADOR TIPO PLUMA	243	GRAPAS, CLAVADORA NEUMÁTICA	204
CAVADORES	250	DESARMADORES DE GOLPE	246	GRAPAS, ESTÁNDAR	204
CEPILLO LIMPIADOR DE TERMINAL DE BATERÍA	267	DESARMADORES, JOYERO	247	GRASA BLANCA DE LITIO	266
CEPILLO PARA CARPINTERO	214	DESARMADORES, MATRACA	247	GUANTES	233
CEPILLO PARA TUBERÍA DE COBRE	220	DESARMADORES, PUNTA CRUZ	246	GUANTES, CARNAZA	233
CEPILLOS DE ALAMBRE	222	DESARMADORES, PUNTA PLANA	246	GUANTES, HULE	233
CHALECOS DE SEGURIDAD	230	DESARMADORES, PUNTAS Y DADOS	247	GUANTES, INDUSTRIALES	233
CHAROLAS PARA PINTAR	257	DESENGRASANTE PARA MOTOR	266	GUANTES, LÁTEX	233
CHIFLÓN PARA MANGUERA	261	DESTORCEDOR DE CADENA	229	GUANTES, NITRIL	233
CHUCK INFLADOR	202	DESTORCEDOR DE MANGUERA	201	GUANTES, NYLON	233
CINCEL	214	DIABLITOS DE CARGA	205	GUANTES, POLIESTER	233
CINTA ANTIDERRAPANTE	234	DISCOS DE CORTE PARA ACERO	227	GUANTES, VINILO	233
CINTA BARRICADA	232	DISCOS DE CORTE PARA CONCRETO	227	<b>H</b>	
CINTA CANELA	234	DISCOS DE CORTE PARA METAL	227	HACHAS	248
CINTA DE ALUMINIO	234	DISCOS DE DESBASTE	227	HILO ALBAÑIL	209
CINTA DE FIBRA DE VIDRIO	234	DISCOS DE SIERRA PARA ALUMINIO	226	HILO PARA DESBROZADORA	262
CINTA DE MONTAJE	234	DISCOS DE SIERRA PARA MADERA	226	<b>I</b>	
CINTA GRIS PARA DUCTO	234	DISCOS DIAMANTE	227	IMPULSOR PARA BOMBA DE AGUA	264
CINTA MASKING TAPE	234	DISCOS LAMINADOS	227	INFLADORES DE AIRE	202
CINTA PARA PANEL YESO	234	DISCOS LIJA PARA MADERA	197	INFLALLANTAS	266
CINTA POLIKEN PARA TUBERÍA	234	<b>E</b>		INYECTOR DE GRASA	223
CINTA TRANSPARENTE	234	ELECTRODOS	208	<b>J</b>	
CLAVADORA, NEUMÁTICA	204	EMBUDO FLEXIBLE	223	JUEGO DE ACCESORIOS PARA AIRE	199
CLAVOS	251	ENGRAPADORA, NEUMÁTICA	204	JUEGO DE ACCESORIOS, MANGUERA	199
CLAVOS PARA CLAVADORA NEUMÁTICA	204	ENGRAPADORA, USO RUDO	204	JUEGO DE ACCESORIOS, NEUMÁTICOS	199
COMPRESOR PORTÁTIL	199	EQUIPOS HIDRONEUMÁTICOS	265	JUEGO DE CONECTORES RÁPIDOS	200
COMPRESORES DE AIRE	198	ESCALERAS	258	JUEGO DE CORTADORES DE PRECISIÓN	217
CONECTOR "Y"	260	ESCOBAS DE JARDÍN	263	JUEGO DE CORTATUBOS	220
CONECTOR DE LATÓN PARA HIDRONEUMÁTICO	264	ESCUADRAS	212, 215	JUEGO DE DADOS	240
CONECTORES PARA MANGUERA	260	ESMERIL	225	JUEGO DE DADOS, CUADRO	241
CONECTORES RÁPIDOS	200	ESPÁTULAS	211	JUEGO DE DESARMADOR DE PRECISIÓN	243
CONTADOR MANUAL MECÁNICO	211	ESTUFA PORTÁTIL	259	JUEGO DE EMPAQUES O-RING	223
COPEL HEMBRA	200	EXTENSIONES PARA MANERAL	257	JUEGO DE EQUIPO DE SEGURIDAD	232
COPEL MACHO	200	<b>F</b>		JUEGO DE EXTENSIONES	241
COPELES PARA REMOLQUE	267	FAJA CON TIRANTES	230	JUEGO DE HERRAMIENTAS PARA JARDÍN	262
CORREAS CON GANCHO PARA REMOLQUE	268	FELPAS	257	JUEGO DE LLAVES COMBINADAS	254
CORTADOR DE RAMAS	262	FILTRO SEPARADOR DE AGUA Y ACEITE	201	JUEGO DE LLAVES HEXAGONALES	243
CORTADOR DE VIDRIO	217	FLEXÓMETROS	211	JUEGO DE LLAVES TORX	243
CORTADORA DE AZULEJO	219	FLOTAS DE ESPONJA	210	JUEGO DE PIEDRAS ABRASIVAS	225
CORTADORA DE AZULEJO ELÉCTRICA	219	FORMÓN	214	JUEGO DE PISTOLA PARA SOPLETEAR	199
CORTATUBOS	220	FUMIGADORES	262	JUEGO DE PUNTAS CUADRO	242
CRAYÓN PARA METAL	209	<b>G</b>		JUEGO DE PUNTAS DOBLES	242
CUBREBOCAS	232	GANCHO "S"	229	JUEGO DE PUNTAS PARA TALADRO	242
CUCHARA DE ALBAÑIL	210	GANCHOS PARA PANEL RANURADO	215	JUEGO DE PUNTAS PROFESIONALES	242
				JUEGO DE PUNTAS TORX	242

# ÍNDICE ALFABÉTICO

JUEGO DE REPARACIÓN PARA MANGUERA	202	MANERALES PARA FELPA	257	PINZAS, MULTIUSOS	253
JUEGO DE TIRALÍNEAS	209	MANGO ARTICULADO	241	PINZAS, PELACABLES	253
JUEGO DESARMADOR "T"	243	MANGOS PARA BIELDO	249	PISTOLA APLICADORA DE TAPE	234
JUEGO DESARMADOR RELOJERO	243	MANGOS PARA CAVAHOYOS	249	PISTOLA LAVA MOTORES	202
JUEGOS DE AFINACIÓN	241	MANGOS PARA GUADAÑA	249	PISTOLA PARA JARDÍN CON EXTENSIÓN	262
JUEGOS DE PINZAS	253	MANGOS PARA HACHA	249	PISTOLA PARA SOPLETEAR	199
<b>K</b>		MANGOS PARA MARRO	213	PISTOLA, CALAFATEADORA	255
KIT REPARACIÓN, PISTOLA ALTA PRESIÓN	203	MANGOS PARA MARTILLO	249	PISTOLAS DE GRAVEDAD	201
KIT REPARACIÓN, PISTOLA BAJA PRESIÓN	203	MANGOS PARA PALA	249	PISTOLAS PARA JARDÍN	261
KIT REPARACIÓN, PISTOLA DE GRAVEDAD	203	MANGOS PARA RASTRILLO	249	PISTOLAS PARA PINTAR	201
KITS PARA PINTAR	257	MANGUERA ESPIRAL	199	PISTOLAS, SILICÓN	255
<b>L</b>		MANGUERA FLEXIBLE PARA HIDRONEUMÁTICO	264	POLIPASTO MANUAL	228
LÁPIZ BICOLOR	209	MANGUERA PARA INYECTOR DE GRASA	223	POLVO TIRALÍNEAS	209
LENTE DE PROTECCIÓN	232	MANGUERA USO RUDO PARA COMPRESOR	199	PORTA CRAYÓN PARA METAL	209
LENTE PARA SOLDAR	208	MANGUERA, EXPANDIBLE	261	PRENSA TIPO C	214
LETREROS DE ADVERTENCIA	236	MANGUERAS	260	PRESURIZADOR NEUMÁTICO	264
LIJA BANDA PARA MADERA	197	MANÓMETROS	264	<b>R</b>	
LIJA DE AGUA	225	MARROS	213	RASPADOR CON NAVAJA	217
LIJA PARA ESMERIL	225	MARTILLOS	213	RAYADOR DE ALUMINIO	210
LIJA PARA MADERA	225	MATAMOSCAS	259	REGLA	212
LIMAS	224	MATRACAS	241	REGULADOR DE AIRE CON MANÓMETRO	201
LIMPIADOR PARA CARBURADOR	266	MAZO DE HULE	213	REMACHADORAS	255
LÍNEAS DE VIDA	231	MEDIDOR DE PRESIÓN	202	REMACHES	255
LINTERNAS TEMPESTAD	259	MEMBRANA PARA HIDRONEUMÁTICO	264	REPARADORES PARA MANGUERA	260
LLANAS	210	MÉNSULAS	215	REPUESTOS PARA CUTTERS / NAVAJAS	218
LLANTAS REPUESTO, DIABLITO	205	<b>N</b>		RODILLERAS	231
LLANTAS, BICICLETA	203	NAVAJA DE UN FILO	217	ROLLO TORQUE STRETCH FILM	234
LLANTAS, CARRETILLA	205	NAVAJA PARA CEPILLO	214	<b>S</b>	
LLAVE AJUSTABLE	252	NAVAJA PARA HOBBY	217	SACABOCADOS	216
LLAVE COMBINADA, ESTÁNDAR	254	NAVAJA, REPUESTOS	217	SEGUETAS	219
LLAVE COMBINADA, MILIMÉTRICA	254	NIVELES	212	SEPARADOR DE PISO	220
LLAVE DE CRUZ	266	NUDO PARA CABLE	228	SERRUCHOS	214
LLAVE ESPAÑOLA, ESTÁNDAR	254	NUDO UNIVERSAL	241	SIERRA CORTACÍRCULOS	216
LLAVE ESPAÑOLA, MILIMÉTRICA	254	<b>P</b>		SILICÓN RTV	266
LLAVE PARA TALADRO	243	PALAS	250	SOLDADORAS	206
LLAVE QUITA FILTRO DE ACEITE	267	PARCHES PARA CÁMARA	202	SOLDADORA, MICROALAMBRE	206
LLAVE STILSON	252	PARRILLAS	197	SOLDADORAS ARCO ELÉCTRICO	206
LLAVES PARA GAS	252	PIEDRA PARA AFILAR ABRASIVA	225	SOLDADORAS INVERSORAS	206
LLAVES PARA PLOMERO	252	PIEDRA PARA ESMERIL	225	SOLDADORAS INVERSORAS, ELECTRODO Y TIG	206
LONAS MULTIUSOS	235	PINTURAS EN AEROSOL	256	SOLDADORAS, CORRIENTE ALTERNA	207
LONAS USO RUDO	235	PINZA PARA TIERRA	208	SUJETADOR CON MATRACA	268
LUBRICANTE AFLOJATODO	266	PINZA PORTAELECTRODO	208	SWITCH DE PRESIÓN PARA HIDRONEUMÁTICO	264
<b>M</b>		PINZAS DE PRESIÓN	252	<b>T</b>	
MACHETES	252	PINZAS, CHOFER	253	TALACHOS	248
MALLA HEXAGONAL	251	PINZAS, CORTAPERNO	253	TANQUE PRECARGADO	264
MALLA MOSQUITERA	251	PINZAS, CORTE DIAGONAL	253	TAPÓN AUDITIVO	232
MANDRIL PARA SIERRA SACABOCADOS	216	PINZAS, DE PUNTA	253	TELA CRIBA	251
		PINZAS, ELECTRICISTA	253	TELA MOSQUITERA	251
		PINZAS, EXTENSIÓN	253		

# ÍNDICE ALFABÉTICO

TENSOR DE GANCHO	229
TENSORES ELÁSTICOS	268
TERMINALES PARA BATERÍA	267
TIJERAS PARA PODAR	263
TIJERAS PARA RAMAS	263
TIJERAS, AGUACATERA	263
TIJERAS, AVIACIÓN	252
TIJERAS, HOJALATERO	252
TIJERAS, MULTIUSOS	252
TIJERAS, PODA	263
TIJERAS, RECTAS	263
TORNILLO DE BANCO	214

## V

VIDRIO DE CARETA PARA SOLDAR	208
VOLTEADOR DE ALUMINIO	210

## Z

ZAPAPICOS	248
ZAPATO INDUSTRIAL	231



## A

ABRAZADERA, OMEGA	297
ABRAZADERA, UÑA	297
ALAMBRE DOBLE TWD	296
ANTENAS PARA TV	299

## B

BASES PARA TUBO LED	281
BOTÓN DE TIMBRE, LÍNEA 900	288
BOTÓN PARA TIMBRE, LÍNEA 300	286

## C

CABLE COAXIAL	274
CABLE ELÉCTRICO THW	296
CAJAS ELÉCTRICAS	283
CALENTADORES DE INMERSIÓN	276
CAPUCHÓN PARA CABLE	297
CAUTINES	276
CINCHOS DE PLÁSTICO	297
CINTA AISLANTE	297
CLAVIJAS	283
CONDUCTOR ELÉCTRICO ALUCOBRE	296
CONTACTO ATERRIZADO DE SUPERFICIE	285
CONTACTO USB, LÍNEA 900	289
CONTACTOS INDUSTRIALES	283
CONTACTOS POLARIZADOS	284
CONTACTOS, LÍNEA 300	286
CONTACTOS, LÍNEA 600	287
CONTACTOS, LÍNEA 900	288
CONTACTOS, POLARIZADOS DÚPLEX	285
CORDÓN POT	296

## D

DESARMADOR PROBADOR DE CORRIENTE	276
DIMMER ATENUADOR, LÍNEA 900	289

## E

EXTENSIONES ELÉCTRICAS	275
------------------------	-----

## F

FOCOS	282
-------	-----

## G

GRAPAS PARA CABLE	297
GUÍA PARA ELECTRICISTA	297

## I

INTERRUPTOR CON CONTACTO	285
INTERRUPTORES	284
INTERRUPTORES TERMOMAGNÉTICOS	276
INTERRUPTORES, LÍNEA 600	287
INTERRUPTORES, LÍNEA 300	286

INTERRUPTORES, LÍNEA 900	288
--------------------------	-----

## L

LÍNEA 900, COMBOS	290
LINTERNAS	298
LINTERNAS LED	271
LUCES DE EMERGENCIA	273
LUCES PARA BICICLETA	273
LUMINARIOS LED	277

## M

MULTICONTACTO, 6 SALIDAS	285
MULTICONTACTOS	283
MULTÍMETROS	276

## P

PARRILLAS ELÉCTRICAS	273
PILAS ALCALINAS	276
PLACAS ELÉCTRICAS	284
PLACAS, DÚPLEX	284
PLACAS, LÍNEA 300	286
PLACAS, LÍNEA 600	287
PLACAS, LÍNEA 900	289
PORTA LÁMPARAS	283
PROBADORES DE CIRCUITOS	276
PROBADORES DE CORRIENTE	276
PROBADORES DE VOLTAJE	276

## S

SOCKETS	283
SOPORTES PARA TV	274

## T

TOMA PARA TELÉFONO, LÍNEA 300	286
TOMA PARA TELÉFONO, LÍNEA 600	287
TOMA PARA TELÉFONO, LÍNEA 900	289
TOMA PARA TV, LÍNEA 300	286
TOMA PARA TV, LÍNEA 600	287
TOMA PARA TV, LÍNEA 900	289
TUBOS LED	281



**ANBEC® | ELITE**



**LÍNEA DE LUJO**





**ANBEC** | **ELITE**

**Línea de lujo**

**Morgan**

ONE PIECE  
Cuerpo de cerámica

**Narooma**

ONE PIECE  
Cuerpo de cerámica

- AHORRO**  
Consumo de agua menor a 6 L y capacidad de 1000 g por descarga
- CONFORT**  
Altura confortable de 40 cm
- DISEÑO**  
Forma alargada y asiento de cierre lento

- AHORRO**  
Consumo de agua menor a 6 L y capacidad de 1000 g por descarga
- CONFORT**  
Altura confortable de 40 cm
- DISEÑO**  
Forma alargada y asiento de cierre lento



Grado de calidad "A"  
Primera clase Tipo I



Grado de calidad "A"  
Primera clase Tipo I



CÓDIGO	PRECIO	INNER	MASTER	CÓDIGO	PRECIO	INNER	MASTER
AE2003	\$ 3,450.00	1	1	AE2001	\$ 5,420.00	1	1

### Lausana

Cuerpo de cerámica

Sobrecubierta  
Color blanco

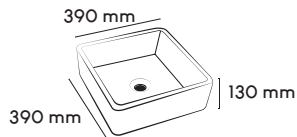

Caja a color

CÓDIGO	PRECIO	INNER	MASTER
AE1002	\$ 860.00	1	1

### Rougemont

Cuerpo de cerámica

Sobrecubierta  
Color blanco

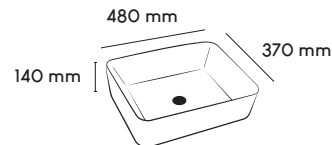

Caja a color

CÓDIGO	PRECIO	INNER	MASTER
AE1004	\$ 890.00	1	1

### Locarno

Cuerpo de cerámica

Submontar  
Con rebosadero  
Color blanco



Caja a color

CÓDIGO	PRECIO	INNER	MASTER
AE1005	\$ 1,100.00	1	1

### Canberra

Cuerpo de cerámica

Sobrecubierta  
Color blanco

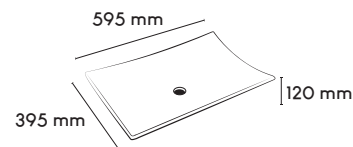

Caja a color

CÓDIGO	PRECIO	INNER	MASTER
AE1006	\$ 1,250.00	1	1

### Basilea

Cuerpo de cerámica

Sobrecubierta  
Color blanco

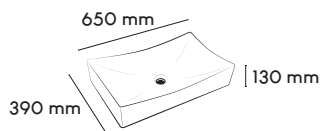

Caja a color

CÓDIGO	PRECIO	INNER	MASTER
AE1001	\$ 1,270.00	1	1

### Maienfeld

Cuerpo de cerámica

Sobreponer  
Con rebosadero  
Color blanco

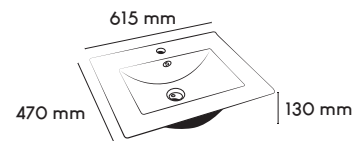

Caja a color

CÓDIGO	PRECIO	INNER	MASTER
AE1003	\$ 1,500.00	1	1

 **ANBEC**®

**PLOMERÍA Y  
VALVULERÍA**





## Ovalín biege

Cuerpo de cerámica

Lavabo de sobrecubierta

Peso: 7.5 Kg.



Caja a color

## Ovalín biege

Cuerpo de cerámica

Lavabo de sobrecubierta

Peso: 8 Kg



Para mezcladora monomando  
Caja a color

## Ovalín biege

Cuerpo de cerámica

Lavabo de sobrecubierta

Peso: 12 Kg

Rebosadero posterior



Para mezcladora monomando  
Caja a color

CÓDIGO	DESCRIPCIÓN	PRECIO	INNER	MASTER
ABOV1830	Anti-rayaduras	\$ 1,125.00	1	1

CÓDIGO	DESCRIPCIÓN	PRECIO	INNER	MASTER
ABOV1832	Anti-rayaduras	\$ 1,170.00	1	1

CÓDIGO	DESCRIPCIÓN	PRECIO	INNER	MASTER
ABOV1828	Anti-rayaduras	\$ 1,300.00	1	1

## Combo lavabo biege + kit de herrajes

El combo incluye:

Mueble: **Montanari** tabaco

Ovalín biege: **ABOV1830**

Espejo ( Acabado tabaco )

Largo: **52 cm**, Alto: **60 cm** y Profundidad: **1.6 cm**

### kit de herrajes:

Mezcladora: **MEZL140C**  
 Dos llaves de retención: **LLARAVCR**  
 Dos alimentadores: **ALILV55**  
 Contra rejilla: **CONLCZ**  
 Césped: **TRAL431**  
 Conector céspol: **CONC114**



Alto: 69.5 cm

Largo: 63 cm

Ancho: 43 cm

## Combo lavabo biege + kit de herrajes

El combo incluye:

Mueble: **Montanari** tabaco

Ovalín biege: **ABOV1832**

Espejo ( Acabado tabaco )

Largo: **52 cm**, Alto: **60 cm** y Profundidad: **1.6 cm**

### kit de herrajes:

Mezcladora: **MEZL139C**  
 Dos llaves de retención: **LLARAVCR**  
 Dos alimentadores: **ALILV55**  
 Contra rejilla: **CONLCZ**  
 Césped: **TRAL431**  
 Conector céspol: **CONC114**



Alto: 69.5 cm

Largo: 63 cm

Ancho: 43 cm

## Combo lavabo biege + kit de herrajes

El combo incluye:

Mueble: **Montanari** tabaco

Ovalín biege: **ABOV1828**

Espejo ( Acabado tabaco )

Largo: **52 cm**, Alto: **60 cm** y Profundidad: **1.6 cm**

### kit de herrajes:

Mezcladora: **MEZL139C**  
 Dos llaves de retención: **LLARAVCR**  
 Dos alimentadores: **ALILV55**  
 Contra rejilla: **CONLCZ**  
 Césped: **TRAL431**  
 Conector céspol: **CONC114**



Alto: 67 cm

Largo: 62 cm

Ancho: 35 cm

CÓDIGO	DESCRIPCIÓN
ABM01911	Tabaco

CÓDIGO	DESCRIPCIÓN
ABM01912	Tabaco

CÓDIGO	DESCRIPCIÓN
ABM01913	Tabaco

## Contra para lavabo 1 1/4"

Cuerpo de latón  
Sin rebosadero



ABCS1855

ABCS1856

CÓDIGO  
ABCS1855  
ABCS1856

DESC.  
Redondo  
Cuadrado

## Contra para lavabo 1 1/4"

Cuerpo de latón  
Con rebosadero



ABCS1857

ABCS1858

CÓDIGO  
ABCS1857  
ABCS1858

DESC.  
Redondo  
Cuadrado

## Contra para lavabo 1 1/4"

Cuerpo de latón  
Sin rebosadero



ABCS1859

ABCS1860

CÓDIGO  
ABCS1859  
ABCS1860

DESC.  
Redondo  
Cuadrado

## Asiento para inodoro Gaetta



Caja Ventana

CÓDIGO	DESC.	PRECIO	INN.	MAS.
ANTS1912	Blanco	\$ 265.00	1	12

## Asiento para inodoro Santoro



Caja Ventana

CÓDIGO	DESC.	PRECIO	INN.	MAS.
ANTS1913	Beige	\$ 265.00	1	12

## Asiento para inodoro Varena



Caja Ventana

CÓDIGO	DESC.	PRECIO	INN.	MAS.
ANTS1914	Blanco	\$ 265.00	1	10

## Asiento para inodoro Trento



Caja Ventana

CÓDIGO	DESC.	PRECIO	INN.	MAS.
ANTS1915	Beige	\$ 265.00	1	10

## Mezcladora lavabo

Cuerpo metálico



15 cm de alto

Maneral metálico



Caja

CÓDIGO	DESC.	PRECIO	INN.	MAS.
ABMM1882	Negro mate	\$ 700.00	1	12

## Mezcladora lavabo

Cuerpo metálico



30 cm de alto

Maneral metálico



Caja

CÓDIGO	DESC.	PRECIO	INN.	MAS.
ABMM1883	Negro mate	\$ 1,100.00	1	12

## Mezcladora lavabo

Cuerpo de acero inoxidable



15 cm de alto

Maneral metálico



Caja

CÓDIGO	DESC.	PRECIO	INN.	MAS.
ABMM1884	Negro mate	\$ 550.00	1	12

## Mezcladora lavabo

Cuerpo de acero inoxidable

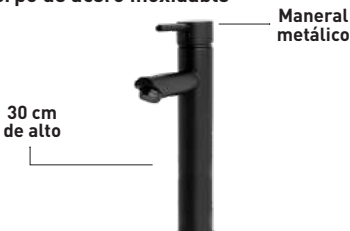

30 cm de alto

Maneral metálico



Caja

CÓDIGO	DESC.	PRECIO	INN.	MAS.
ABMM1885	Negro mate	\$ 650.00	1	12

## Mezcladora lavabo

Cuerpo metálico



17 cm de alto

Maneral metálico



Caja

CÓDIGO	DESC.	PRECIO	INN.	MAS.
ABMM1886	Negro mate	\$ 1,000.00	1	12

## Mezcladora lavabo

Cuerpo metálico



30 cm de alto

Maneral metálico



Caja

CÓDIGO	DESC.	PRECIO	INN.	MAS.
ABMM1887	Negro mate	\$ 1,350.00	1	12



CÓDIGO	PRECIO	INNER	MASTER
ANJH1911	\$ 240.00	1	12

El aspecto, empaque, inner o master de los productos puede variar sin previo aviso debido a la innovación continua de nuestras marcas.

## Tubo PVC

Cédula 40  
Precio de tubo por 3 m



CÓDIGO	MEDIDA	ESPESOR	PRECIO UNITARIO	TUBOS POR ATADO
TPVC1001	1/2"	2.77 mm	\$ 73.00	30
TPVC1002	3/4"	2.87 mm	\$ 98.00	20
TPVC1003	1"	3.38 mm	\$ 149.00	14

## Codo PVC 45°

Cédula 40  
Bolsa con 10 piezas



CÓDIGO	MEDIDA	PRECIO UNITARIO	INN.	MAS.
CPVC1004	1/2"	\$ 3.50	10	700
CPVC1005	3/4"	\$ 4.60	10	450
CPVC1006	1"	\$ 7.50	10	250

## Codo PVC 90°

Cédula 40  
Bolsa con 10 piezas



CÓDIGO	MEDIDA	PRECIO UNITARIO	INN.	MAS.
CPVC1007	1/2"	\$ 3.90	10	650
CPVC1008	3/4"	\$ 6.20	10	350
CPVC1009	1"	\$ 9.00	10	220

## Cople PVC

Cédula 40  
Bolsa con 10 piezas



CÓDIGO	MEDIDA	PRECIO UNITARIO	INN.	MAS.
COPVC1010	1/2"	\$ 2.60	10	900
COPVC1011	3/4"	\$ 3.40	10	600
COPVC1012	1"	\$ 5.30	10	350

## Tapón PVC

Cédula 40  
Bolsa con 10 piezas



CÓDIGO	MEDIDA	PRECIO UNITARIO	INN.	MAS.
TAPVC1013	1/2"	\$ 1.80	10	1,650
TAPVC1014	3/4"	\$ 2.50	10	1,050
TAPVC1015	1"	\$ 3.60	10	650

## Tee PVC

Cédula 40  
Bolsa con 10 piezas



CÓDIGO	MEDIDA	PRECIO UNITARIO	INN.	MAS.
TEPVC1016	1/2"	\$ 5.50	10	440
TEPVC1017	3/4"	\$ 7.20	10	250
TEPVC1018	1"	\$ 11.90	10	135

## Reducción bushing PVC

Cédula 40  
Bolsa con 10 piezas



CÓDIGO	MEDIDA	PRECIO UNITARIO	INN.	MAS.
RBPVC1019	3/4" x 1/2"	\$ 2.50	10	1,200
RBPVC1020	1" x 1/2"	\$ 4.60	10	700
RBPVC1021	1" x 3/4"	\$ 3.70	10	700

## Adaptador macho PVC

Cédula 40  
Bolsa con 10 piezas



CÓDIGO	MEDIDA	PRECIO UNITARIO	INN.	MAS.
AREPVC1022	1/2"	\$ 3.20	10	1,000
AREPVC1023	3/4"	\$ 4.00	10	650
AREPVC1024	1"	\$ 7.20	10	360

## Adaptador hembra PVC

Cédula 40  
Bolsa con 10 piezas



CÓDIGO	MEDIDA	PRECIO UNITARIO	INN.	MAS.
ARIPVC1025	1/2"	\$ 3.40	10	750
ARIPVC1026	3/4"	\$ 4.20	10	550
ARIPVC1027	1"	\$ 7.50	10	300

## Tuerca unión PVC

Cédula 40  
Bolsa con 10 piezas



CÓDIGO	MEDIDA	PRECIO UNITARIO	INN.	MAS.
TUPVC1028	1/2"	\$ 10.70	10	300
TUPVC1029	3/4"	\$ 19.00	10	200
TUPVC1030	1"	\$ 31.40	10	120

## Kit CPVC

Medida: 1/2"



Unidad de medida: 1 Set

CÓDIGO	DESCRIPCIÓN	PRECIO	INN.	MAS.
ANKC1822	Sin manerales	\$ 300.00	2	20
ANKC1823	Con manerales	\$ 515.00	2	20

## Kit PPR



Unidad de medida: 1 Set

CÓDIGO	MEDIDA	PRECIO	INN.	MAS.
KITPPR1909	1/2"	\$ 525.00	1	20

## Charola de plástico para cubiertos

5 Compartimientos  
Plástico reforzado  
Color blanco

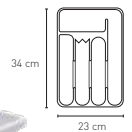

CÓDIGO	DESCRIPCIÓN	PRECIO	INN.	MAS.
ANCH1978	Blanco	\$ 35.00	1	35

**Mezcladora fregadero**

Cuerpo de latón



CÓDIGO	DESCRIPCIÓN	PRECIO	INNER	MASTER
MEZF8015	Cromado	\$ 290.00	1	20

**Mezcladora fregadero**

Cuerpo de latón



CÓDIGO	DESCRIPCIÓN	PRECIO	INNER	MASTER
MEZF8050	Cromado	\$ 295.00	1	20

**Mezcladora fregadero**

Cuerpo de latón

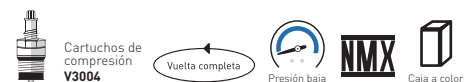

CÓDIGO	DESCRIPCIÓN	PRECIO	INNER	MASTER
MEZF8012	Cromado	\$ 295.00	1	20

**Mezcladora fregadero**

Cuerpo de latón



CÓDIGO	DESCRIPCIÓN	PRECIO	INNER	MASTER
MEZF8010	Cromado	\$ 295.00	1	20

**Mezcladora fregadero**

Cuerpo de latón



CÓDIGO	DESCRIPCIÓN	PRECIO	INNER	MASTER
MEZF8033	Cromado	\$ 315.00	1	20

**Mezcladora fregadero**

Cuerpo de latón



CÓDIGO	DESCRIPCIÓN	PRECIO	INNER	MASTER
MEZF8204	Cromado	\$ 330.00	1	20

**Mezcladora fregadero**

Cuerpo de latón

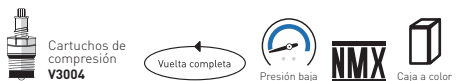

CÓDIGO	DESCRIPCIÓN	PRECIO	INNER	MASTER
MEZF8011	Cromado	\$ 365.00	1	20

**Mezcladora fregadero**

Cuerpo de latón



CÓDIGO	DESCRIPCIÓN	PRECIO	INNER	MASTER
MEZF8044	Cromado	\$ 390.00	1	20

**Mezcladora fregadero**

Cuerpo de latón



CÓDIGO	DESCRIPCIÓN	PRECIO	INNER	MASTER
MEZF8005	Cromado	\$ 400.00	1	20

## Mezcladora fregadero

Cuerpo de latón



CÓDIGO	DESCRIPCIÓN	PRECIO	INNER	MASTER
MEZF473	Cromado	\$ 405.00	1	12

## Mezcladora fregadero

Cuerpo de latón

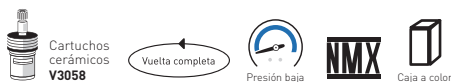

CÓDIGO	DESCRIPCIÓN	PRECIO	INNER	MASTER
MEZF8070	Cromado	\$ 410.00	1	20

## Mezcladora fregadero

Cuerpo de latón



CÓDIGO	DESCRIPCIÓN	PRECIO	INNER	MASTER
MEZF152	Cromado	\$ 470.00	1	12

## Mezcladora fregadero

Cuerpo de latón



CÓDIGO	DESCRIPCIÓN	PRECIO	INNER	MASTER
MEZF472	Cromado	\$ 500.00	1	12

## Mezcladora fregadero

Cuerpo de latón

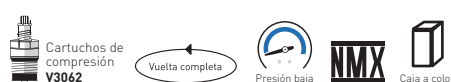

CÓDIGO	DESCRIPCIÓN	PRECIO	INNER	MASTER
MEZF471	Cromado	\$ 600.00	1	12

## Mezcladora fregadero

Cuerpo de latón

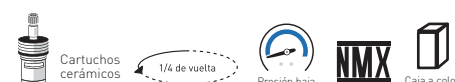

CÓDIGO	DESCRIPCIÓN	PRECIO	INNER	MASTER
MEZF1630	Cromado	\$ 705.00	1	20

## Mezcladora fregadero

Cuerpo de latón

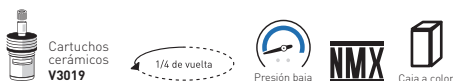

CÓDIGO	DESCRIPCIÓN	PRECIO	INNER	MASTER
MEZF8080	Cromado	\$ 345.00	1	20

## Mezcladora fregadero

Cuerpo de latón

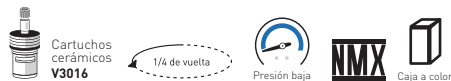

CÓDIGO	DESCRIPCIÓN	PRECIO	INNER	MASTER
MEZF151A	Cromado	\$ 430.00	1	12

## Mezcladora fregadero

Cuerpo de latón



CÓDIGO	DESCRIPCIÓN	PRECIO	INNER	MASTER
MEZF8047	Cromado	\$ 440.00	1	20

**Mezcladora fregadero**

Cuerpo de latón



CÓDIGO	DESCRIPCIÓN	PRECIO	INNER	MASTER
MEZF8055	Cromado	\$ 453.00	1	12

**Mezcladora fregadero**

Cuerpo de latón



CÓDIGO	DESCRIPCIÓN	PRECIO	INNER	MAS.
MEZF8006	Cromado	\$ 465.00	1	12

**Mezcladora fregadero**

Cuerpo de latón



CÓDIGO	DESCRIPCIÓN	PRECIO	INNER	MASTER
MEZF8049	Cromado	\$ 510.00	1	12

**Mezcladora fregadero**

Cuerpo de latón



CÓDIGO	DESCRIPCIÓN	PRECIO	INNER	MASTER
MEZF8051	Cromado/Dorado	\$ 580.00	1	12

**Mezcladora fregadero**

Cuerpo de latón



Incluye manerales: acabado blanco, acrílico y madera.



CÓDIGO	DESCRIPCIÓN	PRECIO	INNER	MASTER
MEZF151L	Cromado	\$ 610.00	1	12

**Mezcladora fregadero**

Cuerpo de latón



CÓDIGO	DESCRIPCIÓN	PRECIO	INNER	MASTER
MEZF151KCP2	Cromado/Dorado	\$ 620.00	1	12

**Mezcladora fregadero**

Cuerpo de latón

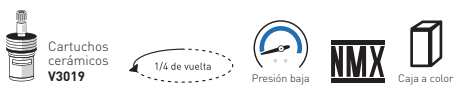

CÓDIGO	DESCRIPCIÓN	PRECIO	INNER	MASTER
MEZF793C	Cromado	\$ 510.00	1	20

**Mezcladora fregadero**

Cuerpo de latón



CÓDIGO	DESCRIPCIÓN	PRECIO	INNER	MASTER
MEZF8009	Cromado	\$ 522.50	1	12

**Mezcladora fregadero**

Cuerpo de latón



CÓDIGO	DESCRIPCIÓN	PRECIO	INNER	MASTER
MEZF991	Cromado	\$ 525.00	1	16

## Mezcladora fregadero

Cuerpo de latón



CÓDIGO	DESCRIPCIÓN	PRECIO	INNER	MASTER
MEZF1758	Cromado	\$ 550.00	1	12

## Mezcladora fregadero

Cuerpo de latón



CÓDIGO	DESCRIPCIÓN	PRECIO	INNER	MASTER
MEZF1643	Cromado	\$ 525.00	1	20

## Mezcladora fregadero

Cuerpo de latón



CÓDIGO	DESCRIPCIÓN	PRECIO	INNER	MASTER
MEZF8041BN	Níquel pulido	\$ 775.00	1	12

## Mezcladora fregadero

Cuerpo de latón



CÓDIGO	DESCRIPCIÓN	PRECIO	INNER	MASTER
MEZF8064	Cromado	\$ 540.00	1	12

## Mezcladora fregadero

Cuerpo de latón



CÓDIGO	DESCRIPCIÓN	PRECIO	INNER	MASTER
MEZF1642	Cromado	\$ 550.00	1	20

## Mezcladora fregadero

Cuerpo de latón



CÓDIGO	DESCRIPCIÓN	PRECIO	INNER	MASTER
MEZF8090	Cromado	\$ 550.00	1	12

## Mezcladora fregadero

Cuerpo de latón

Producto **NUEVO**



CÓDIGO	DESCRIPCIÓN	PRECIO	INNER	MASTER
ABMF1927	Cromado	\$ 565.00	1	12

## Mezcladora fregadero

Cuerpo de latón



CÓDIGO	DESCRIPCIÓN	PRECIO	INNER	MASTER
MEZF790C	Cromado	\$ 570.00	1	20

## Mezcladora fregadero

Cuerpo de latón



CÓDIGO	DESCRIPCIÓN	PRECIO	INNER	MASTER
MEZF1764C	Cromado	\$ 580.00	1	12

El aspecto, empaque, inner o master de los productos puede variar sin previo aviso debido a la innovación continua de nuestras marcas.

**Mezcladora fregadero**

Cuerpo de latón



CÓDIGO	DESCRIPCIÓN	PRECIO	INNER	MASTER
MEZF790BN	Níquel pulido	\$ 660.00	1	20

**Mezcladora fregadero**

Cuerpo de latón



CÓDIGO	DESCRIPCIÓN	PRECIO	INNER	MASTER
MEZF1641	Cromado	\$ 570.00	1	20

**Mezcladora fregadero**

Cuerpo de latón



CÓDIGO	DESCRIPCIÓN	PRECIO	INNER	MASTER
MEZF8088	Cromado	\$ 580.00	1	12

**Mezcladora fregadero**

Cuerpo de latón



CÓDIGO	DESCRIPCIÓN	PRECIO	INNER	MASTER
ABMF1926	Níquel pulido	\$ 640.00	1	12

**Mezcladora fregadero**

Cuerpo de latón



CÓDIGO	DESCRIPCIÓN	PRECIO	INNER	MASTER
MEZF8046C	Cromado	\$ 640.00	1	12

**Mezcladora fregadero**

Cuerpo de latón



CÓDIGO	DESCRIPCIÓN	PRECIO	INNER	MASTER
MEZF8046BN	Níquel pulido	\$ 775.00	1	12

**Mezcladora fregadero**

Cuerpo de latón



CÓDIGO	DESCRIPCIÓN	PRECIO	INNER	MASTER
MEZF8287C	Cromado	\$ 800.00	1	12

**Mezcladora fregadero**

Cuerpo de latón



CÓDIGO	DESCRIPCIÓN	PRECIO	INNER	MASTER
MEZF8287BN	Níquel pulido	\$ 900.00	1	12

**Mezcladora fregadero**

Cuerpo de latón



CÓDIGO	DESCRIPCIÓN	PRECIO	INNER	MASTER
MEZF8286C	Cromado	\$ 800.00	1	12



## Mezcladora fregadero

Cuerpo de latón

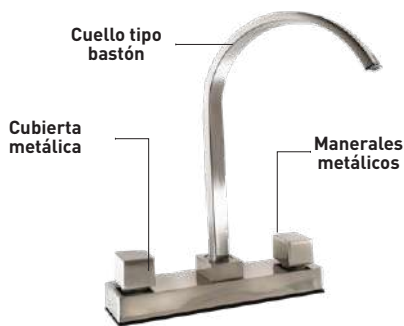

CÓDIGO	DESCRIPCIÓN	PRECIO	INNER	MASTER
MEZF8286BN	Níquel pulido	\$ 900.00	1	12

## Llave monomando

Cuerpo de latón



CÓDIGO	DESCRIPCIÓN	PRECIO	INNER	MASTER
ABLL1932	Cromado	\$ 480.00	1	12

## Mezcladora monomando para fregadero



CÓDIGO	DESCRIPCIÓN	PRECIO
ANMF1792	Cromado	\$ 700.00

## Mezcladora monomando para fregadero

Cuerpo de latón

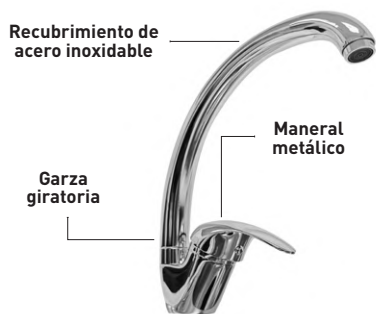

CÓDIGO	DESCRIPCIÓN	PRECIO	INNER	MASTER
MEZF773C	Cromado	\$ 730.00	1	12

## Mezcladora monomando para fregadero

Cuerpo de latón



CÓDIGO	DESCRIPCIÓN	PRECIO	INNER	MASTER
MEZF795C	Cromado	\$ 820.00	1	20

## Mezcladora fregadero

Cuerpo de latón



CÓDIGO	DESCRIPCIÓN	PRECIO	INNER	MASTER
MEZF9220	Cromado	\$ 1,050.00	1	12

## Mezcladora monomando para fregadero

Cuerpo de latón



CÓDIGO	DESCRIPCIÓN	PRECIO	INNER	MASTER
MEZF8082C	Cromado	\$ 1,300.00	1	10

## Mezcladora monomando para fregadero

Cuerpo de latón



CÓDIGO	DESCRIPCIÓN	PRECIO	INN.	MAS.
MEZF8082BN	Níquel pulido	\$ 1,400.00	1	10

## Mezcladora monomando para fregadero

Cuerpo de latón



CÓDIGO	DESCRIPCIÓN	PRECIO	INNER	MASTER
MEZF8084C	Cromado	\$ 1,330.00	1	10

**Mezcladora monomando para fregadero**  
Cuerpo de latón



CÓDIGO	DESCRIPCIÓN	PRECIO	INN.	MAS.
MEZF8084BN	Níquel pulido	\$ 1,460.00	1	10

**Mezcladora monomando para fregadero**  
Cuerpo de latón



CÓDIGO	DESCRIPCIÓN	PRECIO	INNER	MASTER
MEZF8083C	Cromado	\$ 1,359.00	1	10

**Mezcladora monomando para fregadero**  
Cuerpo de latón



CÓDIGO	DESCRIPCIÓN	PRECIO	INN.	MAS.
MEZF8083BN	Níquel pulido	\$ 1,460.00	1	10

**Mezcladora fregadero taladros separados**  
Cuerpo de latón



CÓDIGO	DESCRIPCIÓN	PRECIO	INN.	MASTER
MEZF9212	Cromado	\$ 2,199.00	1	10

**Mezcladora monomando para fregadero**  
Cuerpo de latón



CÓDIGO	DESCRIPCIÓN	PRECIO	INNER	MASTER
MEZF9020	Cromado	\$ 487.00	1	12

**Mezcladora monomando para fregadero**  
Cuerpo de latón



CÓDIGO	DESCRIPCIÓN	PRECIO	INNER	MASTER
MEZF9020BN	Níquel pulido	\$ 540.00	1	12

**Mezcladora monomando para fregadero**  
Cuerpo de latón



CÓDIGO	DESCRIPCIÓN	PRECIO	INNER	MASTER
MEZF15001LC	Cromado	\$ 641.00	1	12

**Mezcladora monomando para fregadero**  
Cuerpo de latón

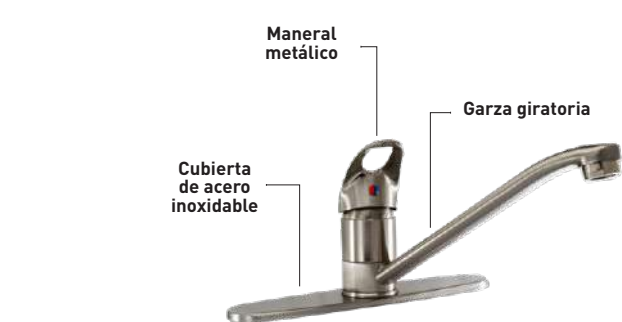

CÓDIGO	DESCRIPCIÓN	PRECIO	INN.	MAS.
MEZF15001LBN	Níquel pulido	\$ 855.00	1	12

El aspecto, empaque, inner o master de los productos puede variar sin previo aviso debido a la innovación continua de nuestras marcas.

## Mezcladora fregadero

Cuerpo de latón



Manerales intercambiables (cromados y dorados)



Cartucho cerámico V3007

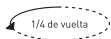

1/4 de vuelta



Presión media



Caja a color

CÓDIGO	DESCRIPCIÓN	PRECIO	INNER	MASTER
MEZF1411CB	Cromado	\$ 999.00	1	12

## Mezcladora monomando para fregadero

Cuerpo de latón



Cartucho cerámico V3021



Presión baja



Caja a color

CÓDIGO	DESCRIPCIÓN	PRECIO	INNER	MASTER
MEZF14901C	Cromado	\$ 1,150.00	1	12

## Mezcladora monomando para fregadero

Cuerpo de latón



Cartucho cerámico V3021



Presión baja



Caja a color

CÓDIGO	DESCRIPCIÓN	PRECIO	INNER	MASTER
MEZF14901BN	Níquel pulido	\$ 1,240.00	1	12

## Mezcladora monomando para fregadero

Cuerpo de latón



Cartucho cerámico V3021



Presión baja



Caja a color

CÓDIGO	DESCRIPCIÓN	PRECIO	INNER	MASTER
MEZF14901W	Cromado	\$ 1,260.00	1	12

## Mezcladora monomando para fregadero

Cuerpo de latón



Cartucho cerámico V3022



Presión media



Caja a color

CÓDIGO	DESCRIPCIÓN	PRECIO	INNER	MASTER
MEZF458C	Cromado	\$ 2,500.00	1	5

## Mezcladora monomando para fregadero

Cuerpo de latón



Cartucho cerámico V3022



Presión media



Caja a color

CÓDIGO	DESCRIPCIÓN	PRECIO	INNER	MASTER
MEZF458BN	Níquel pulido	\$ 2,700.00	1	10

## Mezcladora monomando para fregadero

Cuerpo de latón



Cartucho cerámico V3022



Presión media



Caja a color

CÓDIGO	DESCRIPCIÓN	PRECIO	INNER	MASTER
MEZF459C	Cromado	\$ 2,500.00	1	5

## Mezcladora monomando para fregadero

Cuerpo de latón



Cartucho cerámico V3022



Presión media



Caja a color

CÓDIGO	DESCRIPCIÓN	PRECIO	INNER	MASTER
MEZF459BN	Níquel pulido	\$ 2,800.00	1	5

**Mezcladora monomando para fregadero**  
Cuerpo de latón



**Mezcladora monomando para fregadero**  
Cuerpo de latón



**Mezcladora monomando para fregadero**  
Cuerpo de latón



CÓDIGO	DESCRIPCIÓN	PRECIO	INNER	MASTER
MEZF474	Cromado	\$2,100.00	1	6



CÓDIGO	DESCRIPCIÓN	PRECIO	INNER	MASTER
MEZF457C	Cromado	\$2,900.00	1	5



CÓDIGO	DESCRIPCIÓN	PRECIO	INN.	MAS.
MEZF457BN	Níquel pulido	\$3,200.00	1	5

**Mezcladora monomando para fregadero**  
Cuerpo de latón



**Mezcladora monomando para fregadero**  
Cuerpo de latón

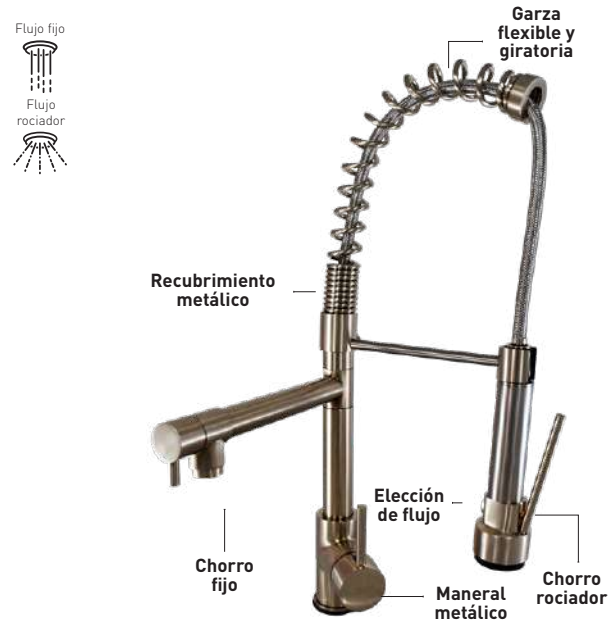

CÓDIGO	DESCRIPCIÓN	PRECIO	INNER	MASTER
MEZF1761C	Cromado	\$3,000.00	1	5



CÓDIGO	DESCRIPCIÓN	PRECIO	INNER	MASTER
MEZF1761BN	Níquel pulido	\$3,300.00	1	5

El aspecto, empaque, inner o master de los productos puede variar sin previo aviso debido a la innovación continua de nuestras marcas.

**Tarja de empotrar tipo bar**

Acero inoxidable   
 2 Agujeros para grifería 15.25 cm   
 Tina brillante

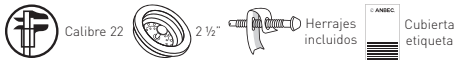

CÓDIGO	DESCRIPCIÓN	PRECIO	INNER	MASTER
TIN15156	Acabado satin	\$ 480.00	1	5

**Tarja de empotrar tipo bar**

Acero inoxidable   
 2 Agujeros para grifería 15.25 cm   
 Tina brillante



CÓDIGO	DESCRIPCIÓN	PRECIO	INNER	MASTER
T1062	Acabado satin	\$ 480.00	1	5

**Tarja de empotrar tipo bar**

Acero inoxidable   
 3 Agujeros para grifería 15.25 cm   
 Tina brillante

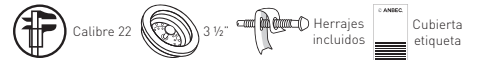

CÓDIGO	DESCRIPCIÓN	PRECIO	INNER	MASTER
T1060	Acabado satin	\$ 480.00	1	5

**Tarja individual de empotrar**

Acero inoxidable   
 3 Agujeros para grifería 15.25 cm   
 Tina brillante

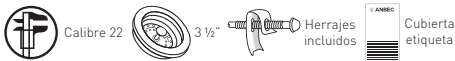

CÓDIGO	DESCRIPCIÓN	PRECIO	INNER	MASTER
T19196	Acabado satin	\$ 600.00	1	5

**Tarja individual de empotrar**

Acero inoxidable   
 3 Agujeros para grifería 15.25 cm   
 Tina brillante

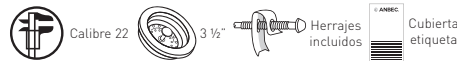

CÓDIGO	DESCRIPCIÓN	PRECIO	INNER	MASTER
TIN25226	Acabado satin	\$ 710.00	1	5

**Tarja de empotrar**

Acero inoxidable   
 3 Agujeros para grifería 15.25 cm   
 Tina brillante

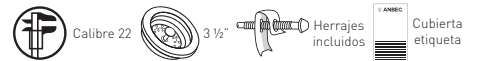
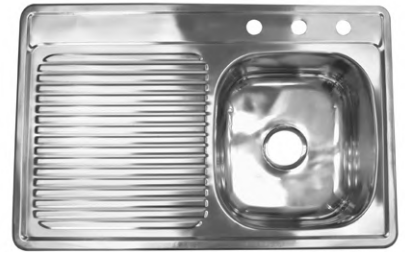

CÓDIGO	DESCRIPCIÓN	PRECIO	INNER	MASTER
T1010	Acabado satin	\$ 625.00	1	5

**Tarja de empotrar**

Acero inoxidable   
 3 Agujeros para grifería 15.25 cm   
 Tina brillante

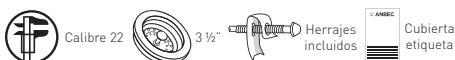

CÓDIGO	DESCRIPCIÓN	PRECIO	INNER	MASTER
T1020	Acabado satin	\$ 625.00	1	5

**Tarja de empotrar**

Acero inoxidable   
 3 Agujeros para grifería 15.25 cm   
 Tina brillante

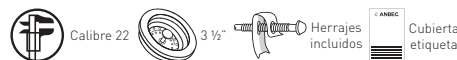
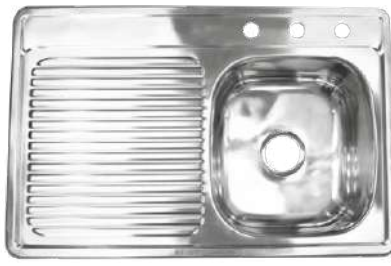

CÓDIGO	DESCRIPCIÓN	PRECIO	INNER	MASTER
T1090	Acabado satin	\$ 730.00	1	5

**Tarja de empotrar**

Acero inoxidable   
 3 Agujeros para grifería 15.25 cm   
 Tina brillante

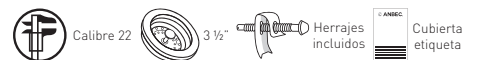
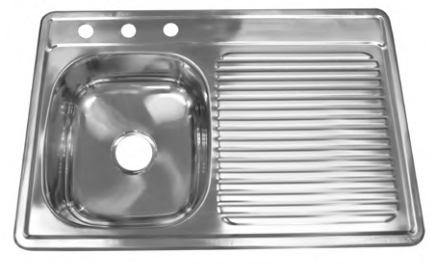

CÓDIGO	DESCRIPCIÓN	PRECIO	INNER	MASTER
T1095	Acabado satin	\$ 730.00	1	5

**Tarja de empotrar**

Acero inoxidable

3 Agujeros para grifería  
Tina brillante

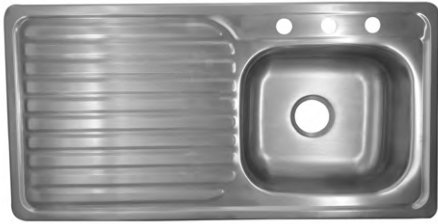
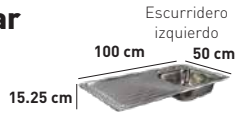

**Tarja de empotrar**

Acero inoxidable

3 Agujeros para grifería  
Tina brillante



**Tarja doble de empotrar**

Acero inoxidable

3 Agujeros para grifería

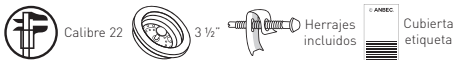

CÓDIGO	DESCRIPCIÓN	PRECIO	INNER	MASTER
T1030	Acabado satin	\$ 760.00	1	5

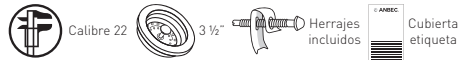

CÓDIGO	DESCRIPCIÓN	PRECIO	INNER	MASTER
T1040	Acabado satin	\$ 760.00	1	5

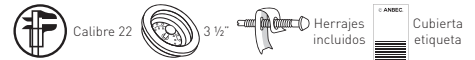

CÓDIGO	DESCRIPCIÓN	PRECIO	INNER	MASTER
TIN33196M	Acabado mate	\$ 705.00	1	5

**Tarja doble de empotrar**

Acero inoxidable

3 Agujeros para grifería  
Tina brillante



**Tarja doble de empotrar**

Acero inoxidable

3 Agujeros para grifería

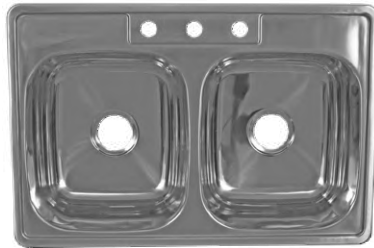
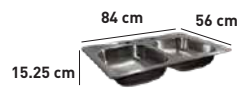

**Tarja doble de empotrar**

Acero inoxidable

3 Agujeros para grifería

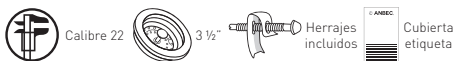

CÓDIGO	DESCRIPCIÓN	PRECIO	INNER	MASTER
TIN33196B	Acabado brillante	\$ 765.00	1	5



CÓDIGO	DESCRIPCIÓN	PRECIO	INNER	MASTER
TIN33226M	Acabado mate	\$ 810.00	1	5

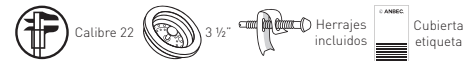

CÓDIGO	DESCRIPCIÓN	PRECIO	INNER	MASTER
TIN33226B	Acabado brillante	\$ 860.00	1	5

**Tarja doble de empotrar**

Acero inoxidable

3 Agujeros para grifería



**Tarja doble de empotrar**

Acero inoxidable

3 Agujeros para grifería  
Tina brillante



**Tarja de sobreponer**

Acero inoxidable

3 Agujeros para grifería

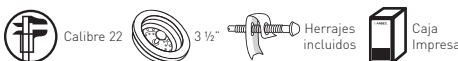
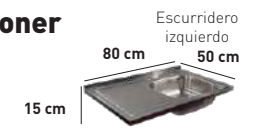

CÓDIGO	DESCRIPCIÓN	PRECIO	INNER	MASTER
TIN33227	Acabado brillante	\$ 1,500.00	1	5

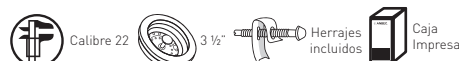

CÓDIGO	DESCRIPCIÓN	PRECIO	INNER	MASTER
TIN33228	Acabado satin	\$ 1,895.00	1	5



CÓDIGO	DESCRIPCIÓN	PRECIO	INNER	MASTER
T2055	Acabado satin	\$ 760.00	1	5

El aspecto, empaque, inner o master de los productos puede variar sin previo aviso debido a la innovación continua de nuestras marcas.



**Tarja de sobreponer**

Acero inoxidable 

3 Agujeros para grifería

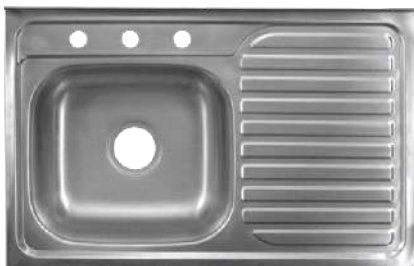

**Tarja de sobreponer**

Acero inoxidable 

3 Agujeros para grifería



CÓDIGO	DESCRIPCIÓN	PRECIO	INNER	MASTER
T2045	Acabado satín	\$ 760.00	1	5

CÓDIGO	DESCRIPCIÓN	PRECIO	INNER	MASTER
T2075	Acabado satín	\$ 900.00	1	5

**Tarja de sobreponer**

Acero inoxidable 

3 Agujeros para grifería



**Tarja individual submontable**

Acero inoxidable 



CÓDIGO	DESCRIPCIÓN	PRECIO	INNER	MASTER
T2065	Acabado satín	\$ 900.00	1	5

CÓDIGO	DESCRIPCIÓN	PRECIO	INNER
T4540	Acabado satín	\$ 736.00	1

**Tarja individual submontable**

Acero inoxidable 



**Tarja individual submontable**

Acero inoxidable 



CÓDIGO	DESCRIPCIÓN	PRECIO	INNER
T2015	Acabado mate	\$ 1,860.00	1

CÓDIGO	DESCRIPCIÓN	PRECIO	INNER
T2080	Acabado mate	\$ 2,300.00	1

**Tarja de sobreponer**

Acero inoxidable  
3 Agujeros para grifería



**Tarja de sobreponer**

Acero inoxidable  
3 Agujeros para grifería  
Tina brillante



CÓDIGO	DESCRIPCIÓN	PRECIO	INNER	MASTER
T1055	Acabado satín	\$ 2,400.00	1	5



CÓDIGO	DESCRIPCIÓN	PRECIO	INNER	MASTER
T1050	Acabado satín	\$ 2,400.00	1	5

**Tarja de empotrar**

Acero inoxidable  
3 Agujeros para grifería  
Tina brillante



**Tarja de empotrar**

Acero inoxidable  
3 Agujeros para grifería  
Tina brillante



CÓDIGO	DESCRIPCIÓN	PRECIO	INNER	MASTER
T1080	Acabado satín	\$ 2,480.00	1	5



CÓDIGO	DESCRIPCIÓN	PRECIO	INNER	MASTER
T1070	Acabado satín	\$ 2,480.00	1	5

**Tarja de empotrar**

Acero inoxidable  
1 Agujero para grifería  
Tina brillante

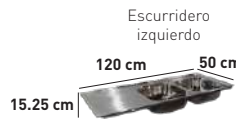

**Tarja de empotrar**

Acero inoxidable  
1 Agujero para grifería  
Tina brillante



CÓDIGO	DESCRIPCIÓN	PRECIO	INNER	MASTER
T1075	Acabado satín	\$ 2,400.00	1	5



CÓDIGO	DESCRIPCIÓN	PRECIO	INNER	MASTER
T1085	Acabado satín	\$ 2,400.00	1	5

El aspecto, empaque, inner o master de los productos puede variar sin previo aviso debido a la innovación continua de nuestras marcas.



Tarja doble submontable

Acero inoxidable 304



Calibre 18



3 1/2"



Herrajes incluidos



Caja Etiqueta

CÓDIGO

DESCRIPCIÓN

PRECIO

INNER

T2010

Acabado mate

\$ 5,282.00

1

Tarja doble submontable

Acero inoxidable 304



Calibre 18



3 1/2"



Herrajes incluidos



Caja Etiqueta

CÓDIGO

DESCRIPCIÓN

PRECIO

INNER

T2000

Acabado satin

\$ 3,412.00

1

Tarja doble submontable

Acero inoxidable 304



Calibre 18



3 1/2"



Herrajes incluidos



Caja Etiqueta

CÓDIGO

DESCRIPCIÓN

PRECIO

INNER

T2005

Acabado mate

\$ 3,412.00

1

Tarja doble submontable

Acero inoxidable 304



Calibre 18



3 1/2"



Herrajes incluidos



Caja Etiqueta

CÓDIGO

DESCRIPCIÓN

PRECIO

INNER

T2025

Acabado mate

\$ 3,412.00

1

Tarja doble de empotrar

Acero inoxidable 304

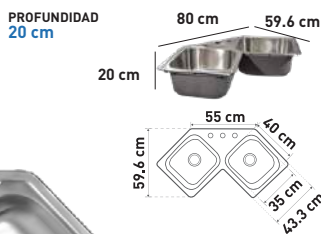

Calibre 22



3 1/2"



Herrajes incluidos



Caja Etiqueta

CÓDIGO

DESCRIPCIÓN

PRECIO

INNER

T2090

Acabado satin

\$ 4,300.00

1

Tarja triple submontable

Acero inoxidable 304

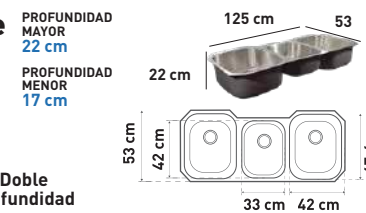

Calibre 18



3 1/2"



Herrajes incluidos



Caja Etiqueta

CÓDIGO

DESCRIPCIÓN

PRECIO

INNER

T2020

Acabado satin

\$ 6,500.00

1

**Tarja doble submontable**

Acero inoxidable 304 

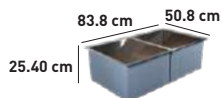

**Tarja doble estilo farmhouse**

Acero inoxidable 304   
Submontable



**Medidas:**  
Ancho: 91.40 cm  
Largo: 50.80 cm  
Alto: 25.40 cm



CÓDIGO	DESCRIPCIÓN	PRECIO	INNER
T1697	Acabado satin	\$ 10,500.00	1

CÓDIGO	DESCRIPCIÓN	PRECIO	INNER
T1698	Acabado satin	\$ 13,000.00	1

**Tarja submontable**

Acero inoxidable 304 



**Tarja doble submontable**

Acero inoxidable 304 



CÓDIGO	DESCRIPCIÓN	PRECIO	INNER
T1699	Acabado satin	\$ 6,200.00	1

CÓDIGO	DESCRIPCIÓN	PRECIO	INNER
T1700	Acabado satin	\$ 11,000.00	1

**Herraje para tina 8 juegos 2"**



**Cubretaladro para fregadero**

Acero inoxidable 



CÓDIGO	PRECIO	INNER	MASTER
HERT	\$ 50.00	8	100

CÓDIGO	DESCRIPCIÓN	PRECIO	INNER	MASTER
CUBFC	Cromado	\$ 20.00	1	100

El aspecto, empaque, inner o master de los productos puede variar sin previo aviso debido a la innovación continua de nuestras marcas.

**Tuerca para contracanasta**



Empaque ajuste completo



**Tuerca para contracanasta**

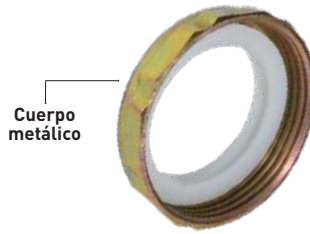

Incluye empaque para tubo ceja



**Cedazo para contracanasta**

Acero inoxidable



CÓDIGO	DESCRIPCIÓN	PRECIO	INNER	MASTER
T5001	Cromado	\$ 35.00	10	100

CÓDIGO	DESCRIPCIÓN	PRECIO	INNER	MASTER
T5005	Metálica	\$ 25.00	20	200

CÓDIGO	DESCRIPCIÓN	PRECIO	INNER	MASTER
CEDCAC	Cromado	\$ 35.00	1	500

**Cedazo para contracanasta original**

Acero inoxidable



**Cedazo para contracanasta universal**

Acero inoxidable



**Contracanasta para fregadero 3 1/2"**

Cuerpo PVC



Cubierta y canastilla de acero inoxidable



CÓDIGO	PRECIO	INNER	MASTER
CEDCO	\$ 28.00	1	150

CÓDIGO	PRECIO	INNER	MASTER
CEDCU	\$ 39.00	1	240

CÓDIGO	DESCRIPCIÓN	PRECIO	INNER	MASTER
CONCPVC	Cromado	\$ 37.00	1	50

**Contracanasta para fregadero 3 1/2"**



Cubierta y canastilla de acero inoxidable



**Contracanasta para bar 2 1/2"**



Canastilla de acero inoxidable



**Contracanasta para fregadero 3 1/2"**

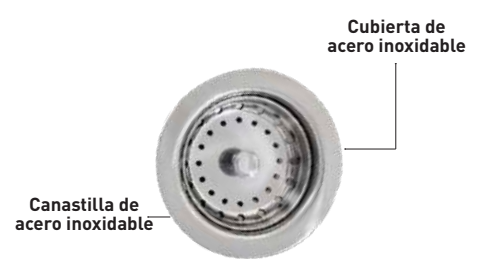

Cubierta de acero inoxidable

Canastilla de acero inoxidable



CÓDIGO	DESCRIPCIÓN	PRECIO	INNER	MASTER
CONCPVCT	Cromado	\$ 42.00	1	50

CÓDIGO	DESCRIPCIÓN	PRECIO	INNER	MASTER
CONMTB	Cromado	\$ 72.00	1	100

CÓDIGO	DESCRIPCIÓN	PRECIO	INNER	MASTER
CONCM	Cromado	\$ 74.00	1	50

**Contracanasta para fregadero 3 1/2"**

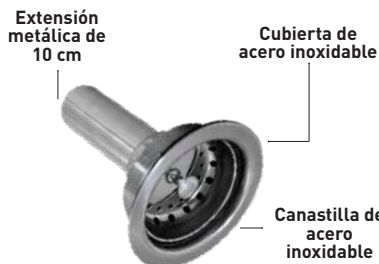

Cubierta de acero inoxidable

Canastilla de acero inoxidable



**Contracanasta para fregadero 3 1/2"**

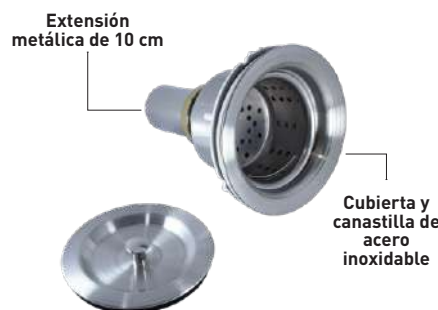

Extensión metálica de 10 cm

Cubierta y canastilla de acero inoxidable



CÓDIGO	DESCRIPCIÓN	PRECIO	INNER	MASTER
CONCMT	Cromado	\$ 84.00	1	50

CÓDIGO	DESCRIPCIÓN	PRECIO	INNER	MASTER
CONCM1998	Cromado	\$ 130.00	1	50

**Manguera para mezcladora monomando**

1/4" x 3/8" x 15 cm



CÓDIGO	PRECIO	INNER	MASTER
MM1720	\$ 116.00	1	100

**Juego de mangueras para mezcladora monomando**

1/4" x 1/2" x 55 cm



CÓDIGO	PRECIO	INNER	MASTER
JMM1455	\$ 90.00	1	100

**Manguera spray para tarja**

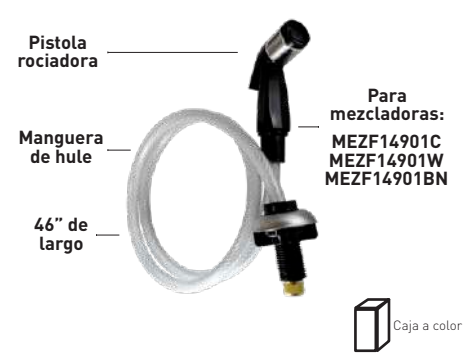

CÓDIGO	PRECIO	INNER	MASTER
MANST	\$ 180.00	1	40

**Manguera para mezcladora**

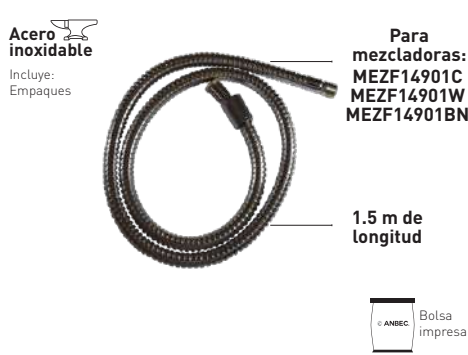

CÓDIGO	PRECIO	INNER	MASTER
M901	\$ 145.00	1	40

**Juego de soportes mezcladora fregadero monomando**

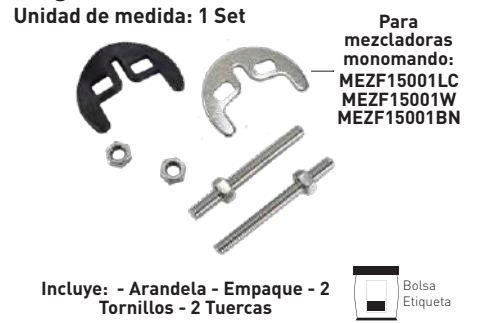

CÓDIGO	PRECIO	INNER	MASTER
JSM200	\$ 23.00	1	500

**Juego de soportes mezcladora fregador monomando**

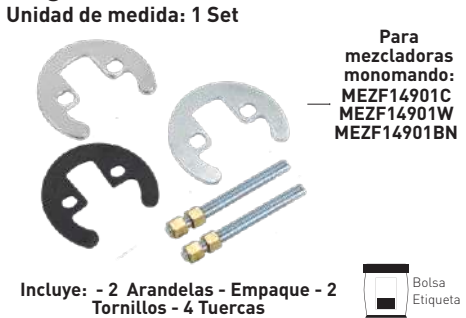

CÓDIGO	PRECIO	INNER	MASTER
JSM201	\$ 33.00	1	400

**Cubierta para mezcladora 4"**



CÓDIGO	DESCRIPCIÓN	PRECIO	INNER	MASTER
CLA4	Redonda 4"	\$ 85.00	1	200

**Cubierta para mezcladora 8"**



CÓDIGO	DESCRIPCIÓN	PRECIO	INNER	MASTER
CFA8	Cuadrada 8"	\$ 130.00	1	250

**Garza para mezcladora monomando**



CÓDIGO	DESCRIPCIÓN	PRECIO	INNER	MASTER
GM901N	Níquel pulido	\$ 275.00	5	50

**Garza para mezcladora monomando**



CÓDIGO	DESCRIPCIÓN	PRECIO	INNER	MASTER
GM901B	Blanco	\$ 275.00	1	50

**Garza para mezcladora monomando**



CÓDIGO	DESCRIPCIÓN	PRECIO	INNER	MASTER
GM901C	Cromado	\$ 275.00	1	50

## Aireador

Bolsa con 10 piezas



Unidad de medida: 1 Set

CÓDIGO	PRECIO	INNER	MASTER
AREMRE	\$ 210.00	10	100

## Aireador

Bolsa con 10 piezas



Unidad de medida: 1 Set

CÓDIGO	PRECIO	INNER	MASTER
AREMRI	\$ 210.00	10	1000

## Tuerca para garza de 12"

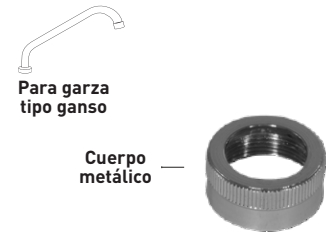

CÓDIGO	PRECIO	INNER	MASTER
TMG12	\$ 17.00	10	1000

## Tuerca para garza



CÓDIGO	PRECIO	INNER	MASTER
TMGCG	\$ 30.00	50	500

## Rociador para mezcladora 2 posiciones



CÓDIGO	PRECIO	INNER	MASTER
ROC2P	\$ 74.00	1	100

## Garza para mezcladora fregadero



CÓDIGO	PRECIO	INNER	MASTER
GAR12	\$ 65.00	5	60

## Garza para mezcladora lavabo



CÓDIGO	DESCRIPCIÓN	PRECIO	INNER	MASTER
GARTB	Cromado	\$ 70.00	10	100

## Garza para mezcladora lavabo



CÓDIGO	DESCRIPCIÓN	PRECIO	INNER	MASTER
GARTBBN	Níquel pulido	\$ 88.00	10	120

## Garza para mezcladora fregadero



CÓDIGO	DESCRIPCIÓN	PRECIO	INNER	MASTER
GARCG	Cromado	\$ 70.00	1	150

## Garza para mezcladora fregadero

Acero inoxidable



CÓDIGO	DESCRIPCIÓN	PRECIO	INNER	MASTER
GARCA	Cromado	\$ 120.00	1	100

## Garza para mezcladora fregadero

Acero inoxidable



CÓDIGO	DESCRIPCIÓN	PRECIO	INNER	MASTER
G2008C	Cromado	\$ 130.00	5	60

## Garza para mezcladora fregadero

Acero inoxidable



CÓDIGO	DESCRIPCIÓN	PRECIO	INNER	MAS.
G2008N	Níquel pulido	\$ 160.00	5	60

**Tubo con ceja 1 1/2"**

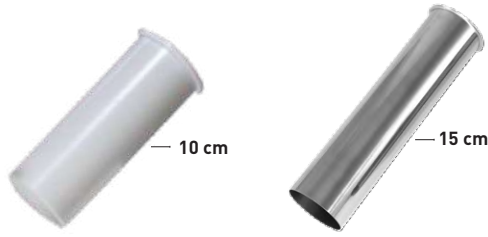

**Extensión fregadero 1 1/2"**

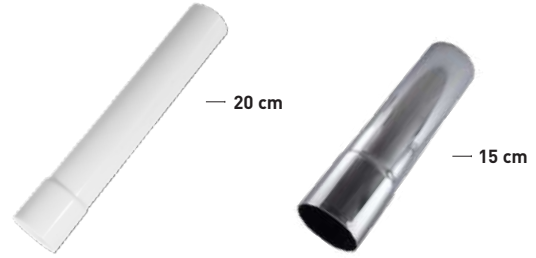

CÓDIGO	DESCRIPCIÓN	PRECIO	INNER	MASTER
TUBC10P	PVC	\$ 5.00	1	200
TUBC15M	Acero inoxidable	\$ 22.00	1	200

CÓDIGO	DESCRIPCIÓN	PRECIO	INNER	MASTER
EXTFPVC	PVC	\$ 13.50	1	100
EXTFM	Acero inoxidable	\$ 40.00	1	200

**Césped flexible para fregadero 1 1/2"**

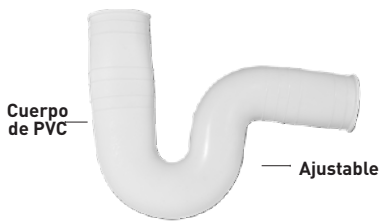

**Césped flexible para fregadero 1 1/2"**



**Césped para fregadero 1 1/2"**

Acero inoxidable



CÓDIGO	PRECIO	INNER	MASTER
TRA452	\$ 53.00	1	50

CÓDIGO	PRECIO	INNER	MASTER
TRAF465	\$ 85.00	1	50

CÓDIGO	DESCRIPCIÓN	PRECIO	INNER	MASTER
TRAFM	Cromado	\$ 195.00	1	30

**Césped doble fregadero 1 1/2"**

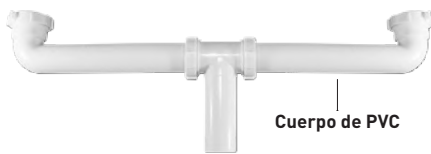

**Césped doble fregadero 1 1/2"**

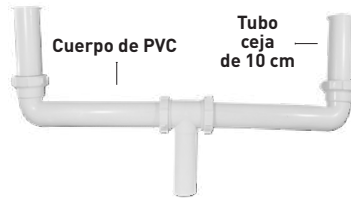

**Césped doble fregadero 1 1/2"**

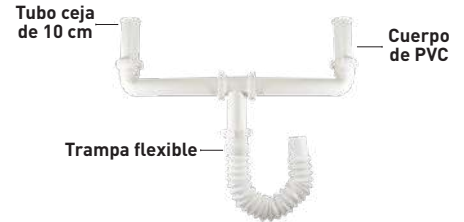

CÓDIGO	DESCRIPCIÓN	PRECIO	INNER	MASTER
DD1040	1 1/2"	\$ 47.00	1	40

CÓDIGO	DESCRIPCIÓN	PRECIO	INNER	MASTER
DD1050	1 1/2"	\$ 52.00	1	40

CÓDIGO	PRECIO	INNER	MASTER
DD1030	\$ 76.00	1	40

**Césped doble fregadero 1 1/2"**

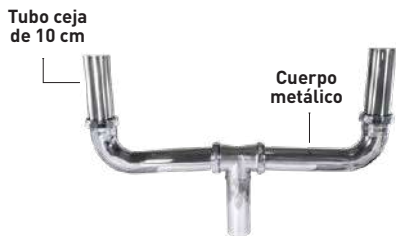

**Césped para fregadero 1 1/2"**



**Césped para fregadero 1 1/2"**

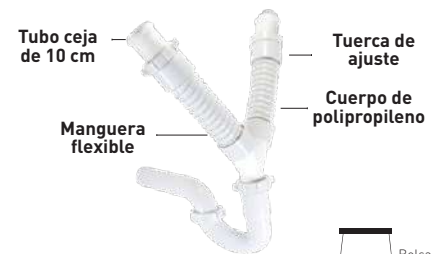

CÓDIGO	PRECIO	INNER	MASTER
DESDFM	\$ 428.00	1	20

CÓDIGO	PRECIO	INNER	MASTER
ABTF1846	\$ 189.00	1	25

CÓDIGO	PRECIO	INNER	MASTER
ABTD1847	\$ 340.00	1	25

## Conector para filtro con empaque



CÓDIGO	PRECIO	INNER	MASTER
CFIE	\$ 23.00	100	500

## Conector para adaptador



CÓDIGO	PRECIO	INNER	MASTER
CF05	\$ 45.00	1	200

## Llave universal para porta garrafón 1/2"



CÓDIGO	PRECIO	INNER	MASTER
LGA1062	\$ 30.00	1	500

## Adaptador para filtro

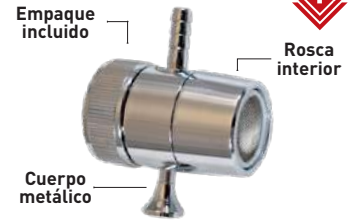

CÓDIGO	PRECIO	INNER	MASTER
ADAF	\$ 170.00	1	200

## Adaptador para filtro

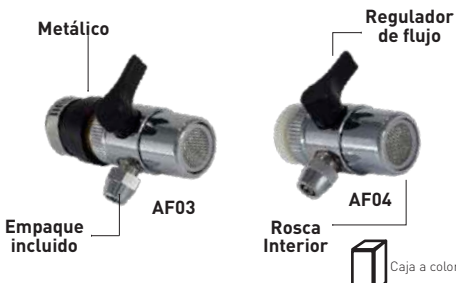

CÓDIGO	DESCRIPCIÓN	PRECIO	INNER	MASTER
AF03	Universal	\$ 162.00	1	100
AF04	Corto	\$ 162.00	1	100

## Garza para filtro



CÓDIGO	PRECIO	INNER	MASTER
GARF	\$ 200.00	1	50

## Garza para filtro



CÓDIGO	PRECIO	INNER	MASTER
GF02	\$ 370.00	1	50

## Repuesto filtro para agua 10,000 L



CÓDIGO	PRECIO	INNER	MASTER
RFA10	\$ 160.00	1	25

## Repuesto para filtro 25,000 L



CÓDIGO	PRECIO	INNER	MASTER
RFA25	\$ 1,050.00	1	1

## Repuesto para filtro 50,000 L



CÓDIGO	PRECIO	INNER	MASTER
RFA50	\$ 1,450.00	1	1

## Filtro para agua 10,000 L



Incluye: Adaptador para garza (AF03)



CÓDIGO	PRECIO	INNER	MASTER
FAA10	\$ 657.00	1	12

## Filtro para agua 25,000 L

Incluye:



CÓDIGO	PRECIO	INNER	MASTER
FAA25	\$ 1,300.00	1	1

## Filtro para agua 50,000 L

Incluye:



CÓDIGO	PRECIO	INNER	MASTER
FAA50	\$ 1,800.00	1	1



# MANERALES

## Juego chapetón para regadera



CÓDIGO	DESCRIPCIÓN	PRECIO	INNER	MASTER
CHARLC	Metálico	\$ 125.00	1	20

## Repuesto para manerales de mezcladora

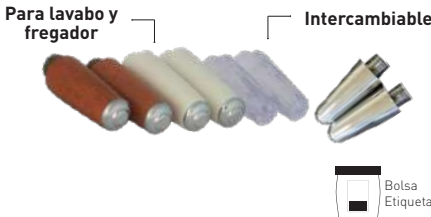

CÓDIGO	DESCRIPCIÓN	PRECIO	INNER	MASTER
JMANIB	Blanco	\$ 24.00	1	200
JMANIC	Cristal	\$ 26.00	1	200
JMANIM	Madera	\$ 32.00	1	200
JMANICR	Cromado	\$ 35.00	1	200

## Juego de manerales con chapetón Espiga estrías



CÓDIGO	DESCRIPCIÓN	PRECIO	INNER	MASTER
JM3808C	Cromado	\$ 135.00	1	100

## Juego chapetón para regadera Cuerpo metálico



CÓDIGO	DESCRIPCIÓN	PRECIO	INNER	MASTER
CHAR017C	Cromado	\$ 70.00	1	80
CHAR017BN	Níquel pulido	\$ 85.00	1	80
CHAR017G	Dorado	\$ 89.00	1	80

## Juego de manerales para lavabo Espiga estrías



CÓDIGO	DESCRIPCIÓN	PRECIO	INNER	MASTER
JM0606	Cromado	\$ 69.00	1	125

## Juego de manerales Espiga estrías



CÓDIGO	DESCRIPCIÓN	PRECIO	INNER	MASTER
JM2708	Cromado	\$ 81.00	1	100

## Juego de manerales con chapetón Espiga estrías



CÓDIGO	DESCRIPCIÓN	PRECIO	INNER	MASTER
JM1356C	Cromado	\$ 137.00	1	100

## Juego de manerales con chapetón Espiga estrías



CÓDIGO	DESCRIPCIÓN	PRECIO	INNER	MASTER
JM616C	Cromado	\$ 145.00	1	60



## Juego de manerales para lavabo Espiga media luna



CÓDIGO	DESCRIPCIÓN	PRECIO	INNER	MASTER
JMANLA	Acrílico	\$ 66.00	1	50

## Juego de manerales Espiga estrías



CÓDIGO	DESCRIPCIÓN	PRECIO	INNER	MASTER
JMRTA	Acrílico	\$ 100.00	1	40

## Juego de manerales Espiga estrías



CÓDIGO	DESCRIPCIÓN	PRECIO	INNER	MASTER
JMRT803A	Acrílico	\$ 95.00	1	50

## Juego de manerales para lavabo Espiga estrías



CÓDIGO	DESCRIPCIÓN	PRECIO	INNER	MASTER
JMREA	Acrílico	\$ 109.00	1	80

## Juego de manerales Espiga estrías



CÓDIGO	DESCRIPCIÓN	PRECIO	INNER	MASTER
JMRTM	Cromado	\$ 142.00	1	50

## Juego de manerales con chapetón Espiga estrías



CÓDIGO	DESCRIPCIÓN	PRECIO	INNER	MASTER
JM214A	Acrílico	\$ 235.00	1	24

## Juego de manerales con chapetón Espiga estrías



CÓDIGO	DESCRIPCIÓN	PRECIO	INNER	MASTER
JM213AZ	Acrílico azul	\$ 235.00	1	60

## Juego de manerales con chapetón Espiga estrías



CÓDIGO	DESCRIPCIÓN	PRECIO	INNER	MASTER
JM213H	Humo	\$ 235.00	1	24

## Juego de manerales con chapetón



CÓDIGO	DESCRIPCIÓN	PRECIO	INNER	MASTER
JM1652C	Cromado	\$ 185.00	1	80

## Juego de manerales con chapetón



CÓDIGO	DESCRIPCIÓN	PRECIO	INNER	MASTER
JM1651C	Cromado	\$ 185.00	1	80

## Juego de manerales con chapetón



CÓDIGO	DESCRIPCIÓN	PRECIO	INNER	MASTER
JM1650C	Cromado	\$ 185.00	1	80

## Juego de manerales con chapetón Espiga estrías



CÓDIGO	DESCRIPCIÓN	PRECIO	INNER	MASTER
JM192C	Cromado	\$ 200.00	1	24

El aspecto, empaque, inner o master de los productos puede variar sin previo aviso debido a la innovación continua de nuestras marcas.

**Juego de manerales con chapetón**

Espiga estrías



CÓDIGO	DESCRIPCIÓN	PRECIO	INNER	MASTER
JM505BC	Cromado	\$ 260.00	1	24

**Juego de manerales con chapetón**

Espiga estrías

Cuerpo metálico



CÓDIGO	DESCRIPCIÓN	PRECIO	INNER	MASTER
JM500C	Cromado	\$ 310.00	1	24

**Juego de manerales con chapetón**

Espiga estrías

Cuerpo metálico



CÓDIGO	DESCRIPCIÓN	PRECIO	INNER	MASTER
JM510BN	Níquel pulido	\$ 380.00	1	24

**Juego de manerales con chapetón**

Espiga estrías



CÓDIGO	DESCRIPCIÓN	PRECIO	INNER	MASTER
JM6027	Cromado	\$ 260.00	1	36

**Juego de manerales con chapetón**

Espiga estrías



CÓDIGO	DESCRIPCIÓN	PRECIO	INNER	MASTER
JM016CD	Dorado / Cromado	\$ 285.00	1	36

**Juego de manerales con chapetón**

Espiga estrías



CÓDIGO	DESCRIPCIÓN	PRECIO	INNER	MASTER
JM016BC	Blanco / Cromado	\$ 260.00	1	36

**Juego de manerales con chapetón**

Espiga estrías



CÓDIGO	DESCRIPCIÓN	PRECIO	INNER	MASTER
JM6059C	Cromado	\$ 290.00	1	24

**Juego de manerales con chapetón**

Espiga estrías



CÓDIGO	DESCRIPCIÓN	PRECIO	INNER	MASTER
JM6059BN	Níquel pulido	\$ 375.00	1	24

**Juego de manerales con chapetón**

Espiga estrías



CÓDIGO	DESCRIPCIÓN	PRECIO	INNER	MASTER
JM019C	Cromado	\$ 331.00	1	24

**Juego de manerales con chapetón**

Espiga estrías



CÓDIGO	DESCRIPCIÓN	PRECIO	INNER	MASTER
JM019	Dorado / Cromado	\$ 360.00	1	24

**Juego de manerales con chapetón**

Espiga estrías



CÓDIGO	DESCRIPCIÓN	PRECIO	INNER	MASTER
JM019S	Satín	\$ 398.00	1	24

**Juego de manerales con chapetón**

Espiga estrías



CÓDIGO	DESCRIPCIÓN	PRECIO	INNER	MASTER
JM0842	Blanco / Dorado	\$ 325.00	1	24

## Juego de manerales con chapetón

Espiga estrías

Cuerpo metálico



CÓDIGO	DESCRIPCIÓN	PRECIO	INNER	MASTER
JM0848	Dorado / Cromado	\$ 315.00	1	24

## Juego de manerales con chapetón

Espiga estrías

Cuerpo metálico



CÓDIGO	DESCRIPCIÓN	PRECIO	INNER	MASTER
JM0872	Blanco / Cromado	\$ 345.00	1	24

## Juego de manerales con chapetón

Espiga estrías

Cuerpo metálico



CÓDIGO	DESCRIPCIÓN	PRECIO	INNER	MASTER
JM0846	Níquel pulido / Blanco	\$ 390.00	1	24

## Juego de manerales con chapetón

Espiga estrías

Cuerpo metálico



CÓDIGO	DESCRIPCIÓN	PRECIO	INNER	MASTER
JMA824C	Cromado	\$ 355.00	1	24

## Juego de manerales con chapetón

Espiga estrías

Cuerpo metálico



CÓDIGO	DESCRIPCIÓN	PRECIO	INNER	MASTER
JMA824	Dorado / Cromado	\$ 360.00	1	24

## Juego de manerales con chapetón

Espiga estrías

Cuerpo metálico



CÓDIGO	DESCRIPCIÓN	PRECIO	INNER	MASTER
JMA824BN	Níquel pulido	\$ 435.00	1	24

## Juego de manerales con chapetón

Espiga estrías

Cuerpo metálico



CÓDIGO	DESCRIPCIÓN	PRECIO	INNER	MASTER
JMA821	Dorado	\$ 435.00	1	24

## Juego de manerales con chapetón

Espiga estrías

Cuerpo metálico



CÓDIGO	DESCRIPCIÓN	PRECIO	INNER	MASTER
JM6012C	Cromado	\$ 365.00	1	24

## Juego de manerales con chapetón

Espiga estrías

Cuerpo metálico



CÓDIGO	DESCRIPCIÓN	PRECIO	INNER	MASTER
JMR847	Dorado / Cromado	\$ 380.00	1	24

## Juego de manerales con chapetón

Espiga estrías



CÓDIGO	DESCRIPCIÓN	PRECIO	INNER	MASTER
JM6012S	Satín / Cromado	\$ 410.00	1	24

## Juego de manerales con chapetón

Espiga estrías



CÓDIGO	DESCRIPCIÓN	PRECIO	INNER	MASTER
JM6018G	Dorado	\$ 433.00	1	24

## Juego de manerales con chapetón

Espiga estrías

Cuerpo metálico



CÓDIGO	DESCRIPCIÓN	PRECIO	INNER	MASTER
JMH804	Dorado / Cromado	\$ 380.00	1	24

**Juego de llaves de empotrar soldables 1/2"**  
Cuerpo de latón



CÓDIGO	PRECIO	INNER	MASTER
JE004	\$ 260.00	1	50

**Juego de llaves de empotrar roscables 1/2"**  
Cuerpo de latón



CÓDIGO	PRECIO	INNER	MASTER
JE002	\$ 260.00	1	50

**Juego de llaves de empotrar soldables 1/2"**  
Cuerpo de latón  
Espiga estrías  
Incluye: manerales metálicos con chapetón



CÓDIGO	PRECIO	INNER	MASTER
JESM	\$ 400.00	1	40

**Juego de llaves de empotrar roscables 1/2"**  
Cuerpo de latón  
Espiga estrías  
Incluye: manerales metálicos con chapetón



CÓDIGO	PRECIO	INNER	MASTER
JERM	\$ 400.00	1	40

**Juego de llaves de empotrar roscables 1/2"**  
Cuerpo de latón  
Incluye: manerales metálicos con chapetón



CÓDIGO	PRECIO	INNER	MASTER
JE001	\$ 390.00	1	40

**Juego de llaves de empotrar soldables 1/2"**  
Cuerpo de latón  
Incluye: manerales metálicos con chapetón



CÓDIGO	PRECIO	INNER	MASTER
JE003	\$ 390.00	1	40

**Juego de llaves de empotrar soldables 1/2"**  
Cuerpo de latón  
Espiga estrías  
Incluye: manerales acrílicos y chapetones metálicos



CÓDIGO	PRECIO	INNER	MASTER
JESA	\$ 365.00	1	40

**Juego de llaves de empotrar roscables 1/2"**  
Cuerpo de latón  
Espiga estrías  
Incluye: manerales acrílicos y chapetones metálicos

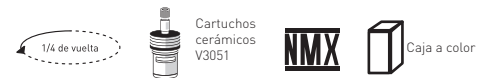

CÓDIGO	PRECIO	INNER	MASTER
JERA	\$ 365.00	1	40

**Juego de llaves de empotrar roscables 1/2"**  
Cuerpo de latón  
Incluye: manerales y chapetones metálicos  
JM1652C



CÓDIGO	PRECIO	INNER	MASTER
JE1649	\$ 425.00	1	40

**Juego de llaves de empotrar roscables 1/2"**  
Cuerpo de latón  
Incluye: manerales y chapetones metálicos  
JM1651C



CÓDIGO	PRECIO	INNER	MASTER
JE1648	\$ 425.00	1	40

**Juego de llaves de empotrar roscables 1/2"**  
Cuerpo de latón  
Incluye: manerales y chapetones metálicos  
JM1650C



CÓDIGO	PRECIO	INNER	MASTER
JE1647	\$ 425.00	1	40

## Mezcladora para regadera

Cuerpo de latón



CÓDIGO	DESCRIPCIÓN	PRECIO	INNER	MASTER
MEZR8236C	Cromado	\$ 840.00	1	12
MEZR8236BN	Níquel pulido	\$ 900.00	1	12

## Mezcladora para regadera

Cuerpo de latón

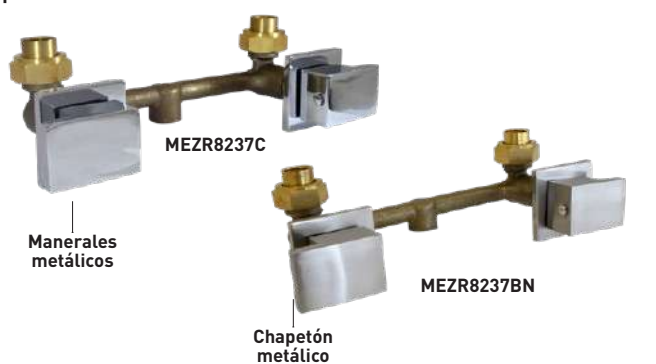

CÓDIGO	DESCRIPCIÓN	PRECIO	INNER	MASTER
MEZR8237C	Cromado	\$ 900.00	1	12
MEZR8237BN	Níquel pulido	\$ 1,049.00	1	12

## Set de mezcladora y regadera

Cuerpo de latón



CÓDIGO	DESCRIPCIÓN	PRECIO	INN.	MAS
MEZR2001	Cromado	\$ 1,000.00	1	10

## Set de mezcladora y regadera

Cuerpo de latón



CÓDIGO	DESCRIPCIÓN	PRECIO	INNER	MASTER
MEZR1801	Cromado	\$ 1,020.00	1	10

## Set de mezcladora y regadera

Cuerpo de latón



CÓDIGO	DESCRIPCIÓN	PRECIO	INNER	MAS.
MEZR1802	Cromado	\$ 1,030.00	1	12

## Set de mezcladora, regadera y salida tina

Cuerpo de latón



CÓDIGO	DESCRIPCIÓN	PRECIO	INNER	MASTER
MEZR1812	Cromado	\$ 1,550.00	1	12

## Set de mezcladora, regadera y salida tina

Cuerpo de latón



CÓDIGO	DESCRIPCIÓN	PRECIO	INNER	MASTER
MEZR1811	Cromado	\$ 1,670.00	1	12

**Mezcladora monomando para regadera**



CÓDIGO	DESCRIPCIÓN	PRECIO	INNER	MASTER
MEZRT2008	Cromado	\$ 656.00	1	20

**Mezcladora monomando para regadera**



CÓDIGO	DESCRIPCIÓN	PRECIO	INN.	MAS.
MEZRT2008BN	Níquel pulido	\$ 830.00	1	20

**Mezcladora monomando para regadera**



CÓDIGO	DESCRIPCIÓN	PRECIO	INNER	MASTER
MEZR2005	Cromado	\$ 950.00	1	12

**Mezcladora monomando para regadera**



CÓDIGO	DESCRIPCIÓN	PRECIO	INN.	MAS.
MEZR2005BN	Níquel pulido	\$ 1,200.00	1	12

**Mezcladora monomando para regadera**



CÓDIGO	DESCRIPCIÓN	PRECIO	INNER	MASTER
MEZR1238C	Cromado	\$ 950.00	1	12

**Mezcladora monomando para regadera**



CÓDIGO	DESCRIPCIÓN	PRECIO	INNER	MAS.
MEZR1238BN	Níquel pulido	\$ 977.00	1	12

**Mezcladora monomando para regadera**

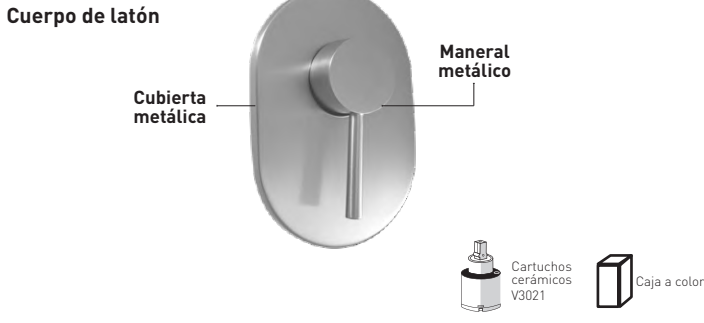

CÓDIGO	DESCRIPCIÓN	PRECIO	INNER	MASTER
MEZR131C	Cromado	\$ 1,199.00	1	20

**Mezcladora monomando para regadera**

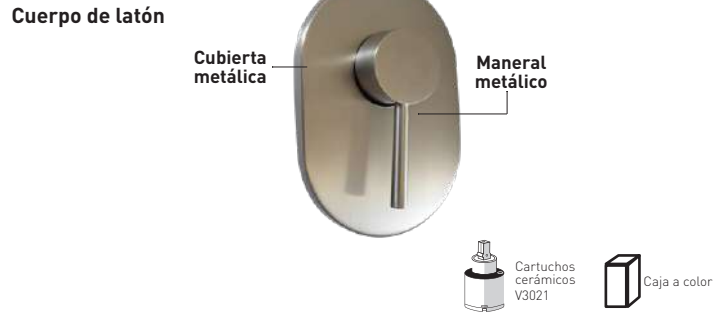

CÓDIGO	DESCRIPCIÓN	PRECIO	INNER	MASTER
MEZR132BN	Níquel pulido	\$ 1,299.00	1	20

**Desagüe para tina de baño**

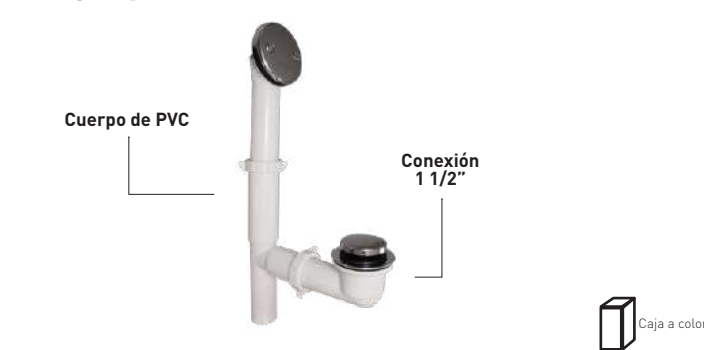

CÓDIGO	PRECIO	INNER	MASTER
DESTPVC	\$ 285.00	1	20

**Desagüe para tina de baño**

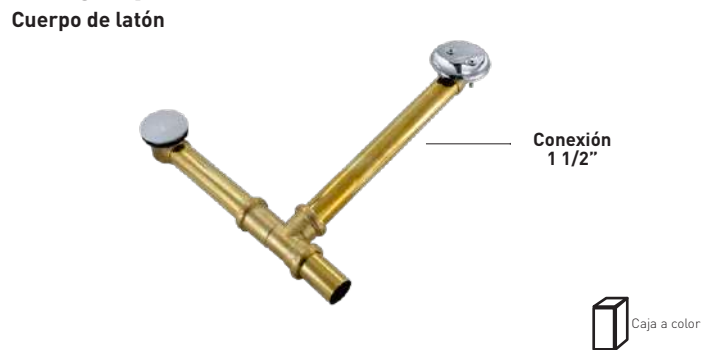

CÓDIGO	PRECIO	INNER	MASTER
DESTL	\$ 1,200.00	1	15

## Set de mezcladora monomando con regadera y salida tina

Cuerpo de latón



CÓDIGO	DESCRIPCIÓN	PRECIO	INNER	MASTER
MEZRT182	Cromado	\$ 1,200.00	1	12

## Set de mezcladora monomando con regadera y salida tina

Cuerpo de latón



CÓDIGO	DESCRIPCIÓN	PRECIO	INN.	MAS.
MEZRT5024GC	Cromado	\$ 1,620.00	1	12

## Set de mezcladora monomando con regadera y salida tina

Cuerpo de latón



CÓDIGO	DESCRIPCIÓN	PRECIO	INN.	MASTER
MEZRT5023C	Cromado	\$ 2,200.00	1	12

## Set de mezcladora monomando con regadera y salida tina

Cuerpo de latón

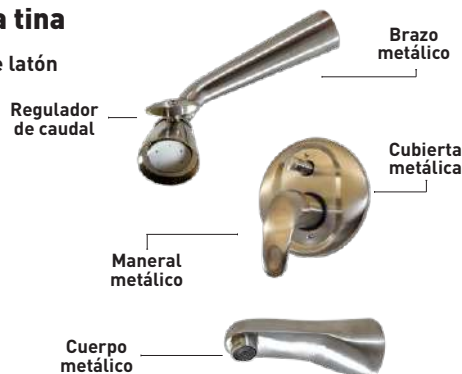

CÓDIGO	DESCRIPCIÓN	PRECIO	INN.	MAS.
MEZRT5023BN	Níquel pulido	\$ 2,763.00	1	12

## Nariz para tina

Cuerpo metálico



CÓDIGO	DESCRIPCIÓN	PRECIO	INNER	MASTER
NART9040	Sin desviador	\$ 185.00	1	60
NART9050	Con desviador	\$ 200.00	1	60

## Botón para tina

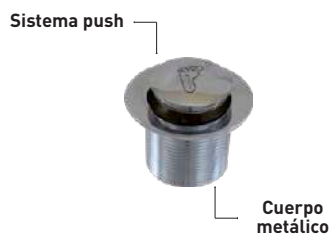

CÓDIGO	DESCRIPCIÓN	PRECIO	INNER	MASTER
PUST	Cromado	\$ 115.00	1	100

## Botón para tina

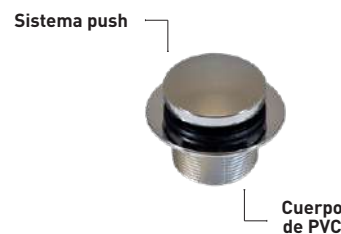

CÓDIGO	DESCRIPCIÓN	PRECIO	INNER	MASTER
PUSTPVC	Cromado	\$ 86.00	1	100

El aspecto, empaque, inner o master de los productos puede variar sin previo aviso debido a la innovación continua de nuestras marcas.

**Brazo chapetón 15 cm**



CÓDIGO	PRECIO	INN.	MAS.
BC1005CP	\$ 23.00	1	200

**Brazo chapetón 15 cm**  
Brazo y chapetón metálicos



CÓDIGO	DESC.	PRECIO	INNER	MASTER
BC1005CM	Acabado cromado	\$ 34.00	1	200
BC1005S	Acabado satin	\$ 86.00	20	200
BC1005DM	Acabado dorado	\$ 90.00	20	200
BC1005BN	Acabado níquel pulido	\$ 90.00	20	200

**Brazo chapetón**  
Brazo y chapetón metálicos

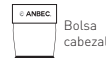
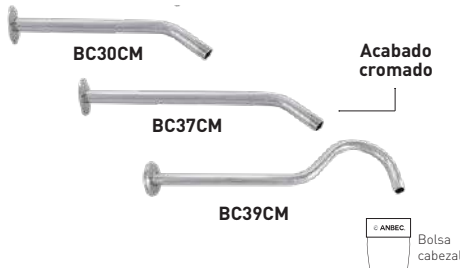

CÓDIGO	DESCRIPCIÓN	PRECIO	INNER	MASTER
BC30CM	30 cm	\$ 75.00	5	120
BC37CM	37 cm	\$ 86.00	5	160
BC39CM	39 cm	\$ 106.00	5	50

**Brazo chapetón**  
Brazo y chapetón metálicos

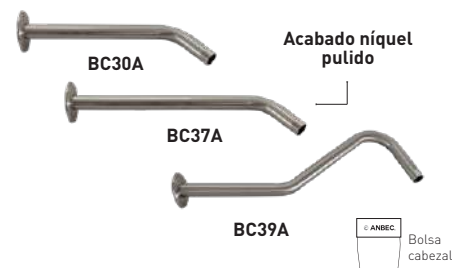

CÓDIGO	DESCRIPCIÓN	PRECIO	INNER	MASTER
BC30A	30 cm	\$ 280.00	5	50
BC37A	37 cm	\$ 285.00	5	50
BC39A	39 cm	\$ 400.00	5	50

**Brazo chapetón 30 cm**  
Brazo y chapetón metálicos



CÓDIGO	DESCRIPCIÓN	PRECIO	INNER	MASTER
BC771C	Cromado	\$ 120.00	10	40
BC772BN	Níquel pulido	\$ 200.00	10	40

**Brazo chapetón 20 cm**  
Brazo y chapetón de acero inoxidable  
Para techo

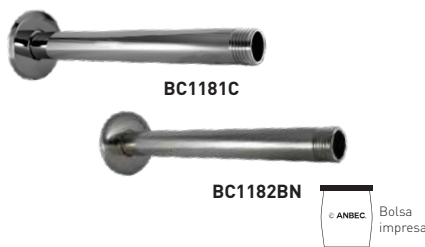

CÓDIGO	DESCRIPCIÓN	PRECIO	INNER	MASTER
BC1181C	Cromado	\$ 205.00	5	50
BC1182BN	Níquel pulido	\$ 220.00	5	50

**Brazo chapetón 20 cm**  
Brazo y chapetón de acero inoxidable  
Para techo

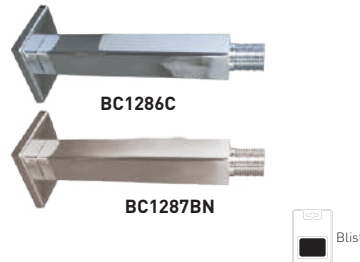

CÓDIGO	DESCRIPCIÓN	PRECIO	INNER	MASTER
BC1286C	Cromado	\$ 295.00	5	50
BC1287BN	Níquel pulido	\$ 320.00	5	50

**Brazo chapetón 40 cm**  
Brazo y chapetón de acero inoxidable



CÓDIGO	DESCRIPCIÓN	PRECIO	INNER	MAS.
BC1282C	Cromado	\$ 428.00	5	50
BC1283BN	Níquel pulido	\$ 504.00	5	50

**Brazo chapetón 40 cm**  
Brazo y chapetón de acero inoxidable  
Para techo



CÓDIGO	DESCRIPCIÓN	PRECIO	INNER	MASTER
BC996C	Cromado	\$ 215.00	5	50
BC997BN	Níquel pulido	\$ 240.00	5	50

**Brazo chapetón 40 cm**  
Brazo y chapetón de acero inoxidable  
Para techo



CÓDIGO	DESCRIPCIÓN	PRECIO	INNER	MASTER
BC1284C	Cromado	\$ 378.00	5	50
BC1285BN	Níquel pulido	\$ 423.00	5	50

**Brazo chapetón 40 cm**  
Brazo y chapetón de acero inoxidable



CÓDIGO	DESCRIPCIÓN	PRECIO	INNER	MASTER
BC1280C	Cromado	\$ 525.00	5	50
BC1281BN	Níquel pulido	\$ 560.00	5	50



Regadera con brazo y chapetón



CÓDIGO	DESCRIPCIÓN	PRECIO	INNER	MASTER
R768	Cromado	\$ 95.00	1	50

Regadera con brazo y chapetón



CÓDIGO	DESCRIPCIÓN	PRECIO	INNER	MASTER
R476	Cromado	\$ 100.00	1	50

Regadera con brazo y chapetón



CÓDIGO	DESCRIPCIÓN	PRECIO	INNER	MASTER
R477	Cromado	\$ 100.00	1	50

Regadera con brazo y chapetón antisarro



CÓDIGO	DESCRIPCIÓN	PRECIO	INNER	MASTER
R1010	Cromado	\$ 130.00	1	50

Regadera con brazo y chapetón



CÓDIGO	DESCRIPCIÓN	PRECIO	INNER	MASTER
R826	Cromado	\$ 125.00	1	20

Regadera con brazo y chapetón



CÓDIGO	DESCRIPCIÓN	PRECIO	INNER	MASTER
R475	Cromado	\$ 160.00	1	50

Regadera con brazo y chapetón



CÓDIGO	DESCRIPCIÓN	PRECIO	INNER	MASTER
RB447C	Cromado	\$ 145.00	30	300

Regadera



CÓDIGO	DESCRIPCIÓN	PRECIO	INNER	MASTER
RCEP	Cromado	\$ 34.00	1	200

Regadera antisarro



CÓDIGO	DESCRIPCIÓN	PRECIO	INNER	MASTER
R1018	Blanco	\$ 41.00	1	100

**Regadera antisarro**



CÓDIGO	DESCRIPCIÓN	PRECIO	INNER	MASTER
R1015	Cromado	\$ 46.00	100	300

**Regadera de masaje**



CÓDIGO	DESCRIPCIÓN	PRECIO	INNER	MASTER
RMCH	Cromado	\$ 102.00	1	100

**Regadera antisarro**

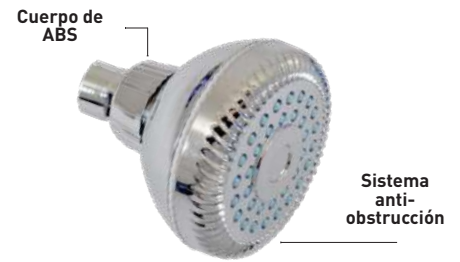

CÓDIGO	DESCRIPCIÓN	PRECIO	INNER	MASTER
R2020	Cromado	\$ 105.00	1	100

**Regadera de masaje**



CÓDIGO	DESCRIPCIÓN	PRECIO	INNER	MASTER
RM5002	Cromado	\$ 142.00	1	100

**Regadera de masaje antisarro**

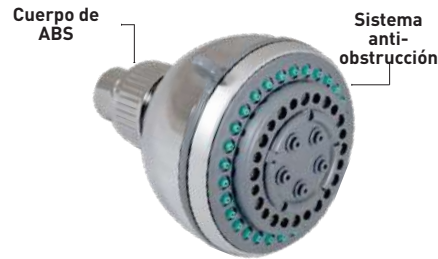

CÓDIGO	DESCRIPCIÓN	PRECIO	INNER	MASTER
REGAML	Cromado	\$ 120.00	1	100

**Regadera campana**

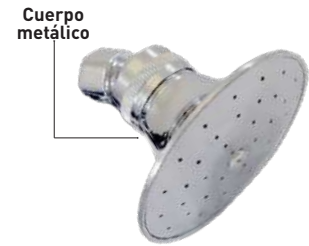

CÓDIGO	DESCRIPCIÓN	PRECIO	INNER	MASTER
R320	Cromado	\$ 110.00	1	150

**Regadera octagonal**



CÓDIGO	DESCRIPCIÓN	PRECIO	INNER	MASTER
R218	Cromado	\$ 110.00	1	100

**Regadera tipo cono**



CÓDIGO	DESCRIPCIÓN	PRECIO	INNER	MASTER
R326	Cromado	\$ 110.00	1	100

**Regadera ahorradora con botón**



CÓDIGO	DESCRIPCIÓN	PRECIO	INNER	MASTER
R009CB	Cromado	\$ 195.00	1	100

El aspecto, empaque, inner o master de los productos puede variar sin previo aviso debido a la innovación continua de nuestras marcas.

Regadera con regulador 2"



CÓDIGO	DESCRIPCIÓN	PRECIO	INNER	MASTER
R005CP	Cromado	\$ 230.00	1	100

Regadera con regulador 2"



CÓDIGO	DESCRIPCIÓN	PRECIO	INNER	MASTER
R1016	Cromado / Dorado	\$ 300.00	1	100

Regadera con regulador 2"



CÓDIGO	DESCRIPCIÓN	PRECIO	INNER	MASTER
R005WK	Blanco / Dorado	\$ 320.00	1	100

Regadera con regulador 2"



CÓDIGO	DESCRIPCIÓN	PRECIO	INNER	MASTER
R005K	Dorado	\$ 340.00	1	100

Regadera con regulador 2"



CÓDIGO	DESCRIPCIÓN	PRECIO	INNER	MASTER
R5019S	Satín	\$ 325.00	1	100

Regadera con regulador 2"



CÓDIGO	DESCRIPCIÓN	PRECIO	INNER	MASTER
R5019BN	Níquel pulido	\$ 345.00	1	100

Regadera redonda

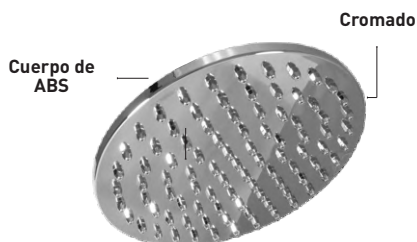

CÓDIGO	DESCRIPCIÓN	PRECIO	INNER	MASTER
RC4	4"	\$ 72.00	1	100
RC6	6"	\$ 150.00	1	50
RC8	8"	\$ 255.00	1	15

Regadera redonda

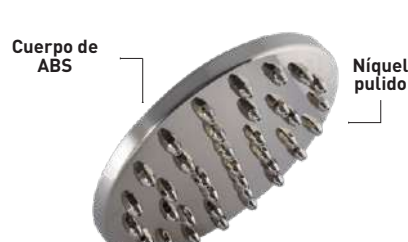

CÓDIGO	DESCRIPCIÓN	PRECIO	INNER	MASTER
R4NP	4"	\$ 100.00	1	100
R6NP	6"	\$ 210.00	1	50
R8NP	8"	\$ 325.00	1	15

Regadera de doble función de cambio de color LED



CÓDIGO	DESCRIPCIÓN	PRECIO	INNER	MASTER
RC595	Cromado	\$ 910.00	1	10

**Regadera cuadrada**

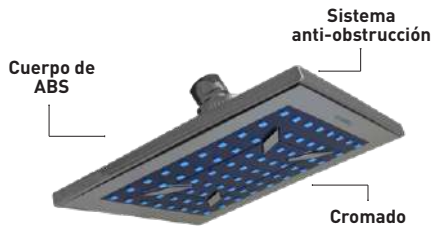

CÓDIGO	DESCRIPCIÓN	PRECIO	INNER	MASTER
R443C	6"	\$ 214.00	1	30
R444C	8"	\$ 295.00	1	30

**Regadera cuadrada**

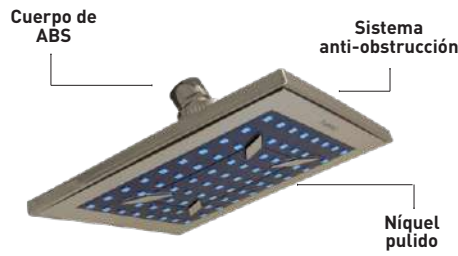

CÓDIGO	DESCRIPCIÓN	PRECIO	INNER	MASTER
R443BN	6"	\$ 275.00	1	30
R444BN	8"	\$ 390.00	1	30

**Regadera tipo plato 8"**



CÓDIGO	DESCRIPCIÓN	PRECIO	INNER	MASTER
RC592	Cromado	\$ 325.00	1	20
R592NP	Níquel pulido	\$ 398.00	1	20

**Regadera cuadrada 6"**

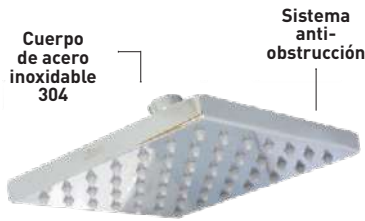

CÓDIGO	DESCRIPCIÓN	PRECIO	INNER	MASTER
R769C	Cromado	\$ 960.00	1	20

**Regadera cuadrada 6"**

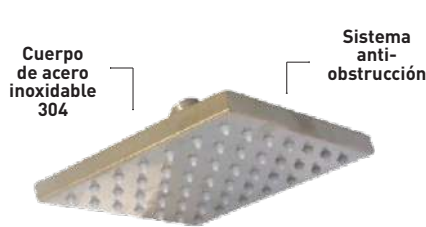

CÓDIGO	DESCRIPCIÓN	PRECIO	INNER	MASTER
R770BN	Níquel pulido	\$ 1,200.00	1	20

**Regadera cuadrada**

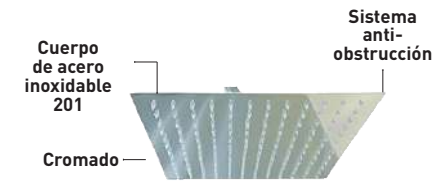

R1784C  
Con brazo  
y chapetón



CÓDIGO	DESCRIPCIÓN	PRECIO	INNER	MASTER
R1784C	4"	\$ 170.00	1	100
R1776C	6"	\$ 170.00	1	54
R1777C	8"	\$ 220.00	1	40
R1778C	10"	\$ 395.00	1	20
R1779C	12"	\$ 550.00	1	20

**Regadera redonda**

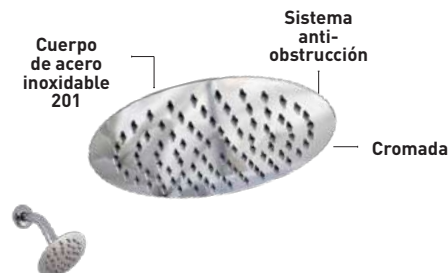

R1785C  
Con brazo  
y chapetón



CÓDIGO	DESCRIPCIÓN	PRECIO	INNER	MASTER
R1785C	4"	\$ 170.00	1	100
R1780C	6"	\$ 170.00	1	54
R1781C	8"	\$ 220.00	1	40
R1782C	10"	\$ 395.00	1	20
R1783C	12"	\$ 550.00	1	20

**Regadera cuadrada**

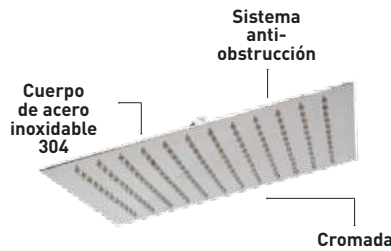

CÓDIGO	DESCRIPCIÓN	PRECIO	INNER	MASTER
R1288C	8"	\$ 595.00	1	10
R994C	12"	\$ 1,152.00	1	8

**Regadera cuadrada**

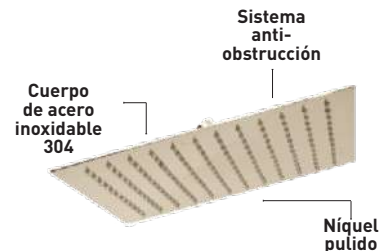

CÓDIGO	DESCRIPCIÓN	PRECIO	INNER	MASTER
R1289BN	8"	\$ 684.00	1	10
R995BN	12"	\$ 1,195.00	1	5

El aspecto, empaque, inner o master de los productos puede variar sin previo aviso debido a la innovación continua de nuestras marcas.

## Regadera eléctrica 127 V

Sistema anti-obstrucción



**Materiales:**

Regadera ABS  
Resistencia Cobre

**Características técnicas**

Voltaje 127 V~  
Corriente eléctrica 42.5 A  
Frecuencia 60 Hz  
Potencia eléctrica 5400 W



CÓDIGO	PRECIO	INNER	MASTER
RE5500	\$ 385.00	1	24

## Regadera eléctrica 110/127 V ~



Selector de temperatura

Rosca de conexión a brazo

**Materiales:**

Regadera ABS Cromado  
Resistencia Cobre

**Características técnicas**

Voltaje 220 V~  
Corriente eléctrica 25 A  
Frecuencia 60 Hz  
Potencia eléctrica 5400 W



CÓDIGO	DESCRIPCIÓN	PRECIO	INNER	MASTER
RE1719	Cromado	\$ 570.00	1	24

## Regadera eléctrica tipo ducha 110/127 V ~

Selector de temperatura



Rosca de conexión a brazo

**Materiales:**

Regadera ABS  
Resistencia Cobre

**Características técnicas**

Voltaje 127 V~  
Corriente eléctrica 31 A  
Frecuencia 60 Hz  
Potencia eléctrica 4000 W



CÓDIGO	PRECIO	INNER	MASTER
RE1720	\$ 1,425.00	1	24

## Regadera eléctrica

Incluye manguera y regadera manual  
Cuerpo de ABS  
Incluye brazo



Control de 3 temperaturas

Sistema anti-obstrucción



CÓDIGO	DESCRIPCIÓN	PRECIO	INNER	MASTER
ANRE1941	127 V~ 45 A 5500 W	\$ 350.00	1	12

## Regadera eléctrica

Incluye manguera y regadera manual  
Cuerpo de ABS  
Incluye brazo



Control de 3 temperaturas

Sistema anti-obstrucción



CÓDIGO	DESCRIPCIÓN	PRECIO	INNER	MASTER
ANRE1943	127 V~ 45 A 5500 W	\$ 360.00	1	12

## Regadera eléctrica

Incluye manguera y regadera manual  
Cuerpo de ABS



Control de 4 temperaturas

Sistema anti-obstrucción



CÓDIGO	DESCRIPCIÓN	PRECIO	INNER	MASTER
ANRE1942	127 V~ 35 A 4000 W	\$ 660.00	1	12

## Brazo para regadera eléctrica

Cuerpo de ABS



BRE218

BRE21718



CÓDIGO	DESC.	PRECIO	INN.	MAS.
BRE218	Blanco	\$ 85.00	1	100
BRE21718	Cromado	\$ 270.00	1	20

## Resistencia para regadera 220/230 V - 110/127 V



Alambre de cobre esmaltado



CÓDIGO	PRECIO	INNER	MASTER
REE	\$ 70.00	10	400

## Resistencia para regadera 127 V~

ANRE1944 - 5,500 W  
Para ANRE1941 y ANRE1943  
ANRE1945 - 4,000 W  
Para ANRE1942



CÓDIGO	PRECIO
ANRE1944	\$ 105.00
ANRE1945	\$ 165.00

## Desviador regadera tipo teléfono



PVC



CÓDIGO	PRECIO	INNER	MASTER
DESRTA	\$ 60.00	1	50

**Regadera 4 posiciones tipo teléfono**



CÓDIGO	DESCRIPCIÓN	PRECIO	INNER	MASTER
R5001	Cromado	\$ 285.00	1	8

**Regadera 3 posiciones con extensión tipo teléfono**



CÓDIGO	DESCRIPCIÓN	PRECIO	INNER	MASTER
R306L	Cromado	\$ 300.00	1	8

**Regadera 5 posiciones con extensión tipo teléfono**

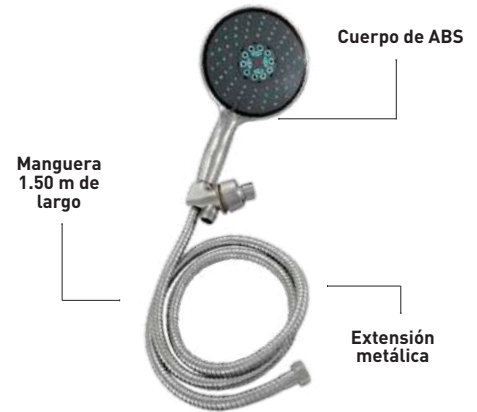

CÓDIGO	DESCRIPCIÓN	PRECIO	INNER	MASTER
R511C	Cromado	\$ 430.00	1	20

**Regadera 3 posiciones con extensión tipo teléfono**



CÓDIGO	DESCRIPCIÓN	PRECIO	INNER	MASTER
R511NP	Níquel pulido	\$ 510.00	1	20

**Regadera masaje tipo teléfono con extensión**

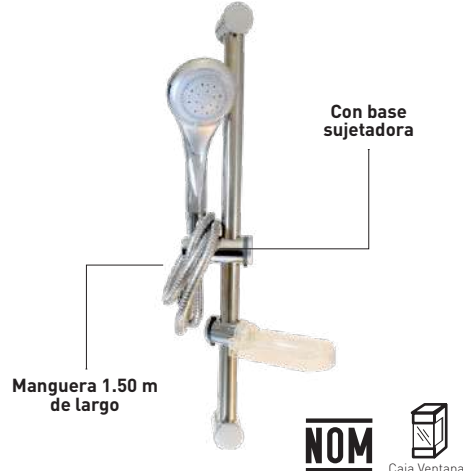

CÓDIGO	DESCRIPCIÓN	PRECIO	INNER	MASTER
RT255BC	Cromado	\$ 460.00	1	10

**Regadera masaje tipo teléfono con extensión**



CÓDIGO	DESCRIPCIÓN	PRECIO	INNER	MASTER
RT247BC	Cromado	\$ 540.00	1	10

**Regadera masaje tipo teléfono con extensión**



CÓDIGO	DESCRIPCIÓN	PRECIO	INNER	MASTER
RT136BC	Cromado	\$ 550.00	1	10

**Kit de regadera**



CÓDIGO	DESCRIPCIÓN	PRECIO	INNER	MASTER
RTR445C	Cromado	\$ 359.00	1	8

**Kit de regadera**

Cuerpo de latón  
Conjunto de regadera

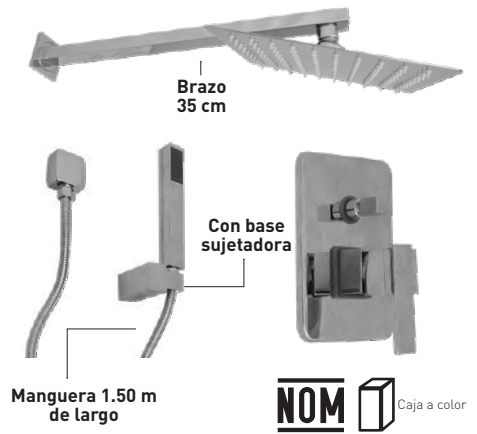

CÓDIGO	DESCRIPCIÓN	PRECIO	INNER	MASTER
RT1763	Cromado	\$ 3,000.00	1	10

## Mezcladora lavabo

Cuerpo de latón



CÓDIGO	DESCRIPCIÓN	PRECIO	INNER	MASTER
MEZL4009	Cromado	\$ 240.00	1	20

## Mezcladora lavabo

Cuerpo de latón

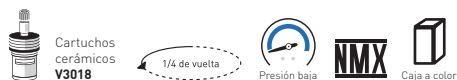

CÓDIGO	DESCRIPCIÓN	PRECIO	INNER	MASTER
MEZL4010	Cromado	\$ 240.00	1	20

## Mezcladora lavabo

Cuerpo de latón



CÓDIGO	DESCRIPCIÓN	PRECIO	INNER	MASTER
MEZL4077	Cromado	\$ 240.00	1	20

## Mezcladora lavabo

Cuerpo de latón

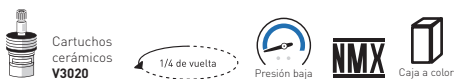

CÓDIGO	DESCRIPCIÓN	PRECIO	INNER	MASTER
MEZL4001	Cromado	\$ 289.00	1	24

## Mezcladora lavabo

Cuerpo de latón

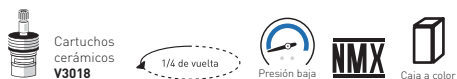

CÓDIGO	DESCRIPCIÓN	PRECIO	INNER	MASTER
MEZL4033	Cromado	\$ 300.00	1	24

## Mezcladora lavabo

Cuerpo de latón



CÓDIGO	DESCRIPCIÓN	PRECIO	INNER	MASTER
MEZL105PP	Cromado	\$ 282.00	1	20

## Mezcladora lavabo

Cuerpo de latón



CÓDIGO	DESCRIPCIÓN	PRECIO	INNER	MASTER
MEZL110PP	Cromado	\$ 282.00	1	20

## Mezcladora lavabo

Cuerpo de latón

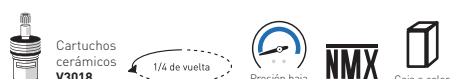

CÓDIGO	DESCRIPCIÓN	PRECIO	INNER	MASTER
MEZL8019	Cromado	\$ 289.00	1	20

## Mezcladora lavabo

Cuerpo de latón

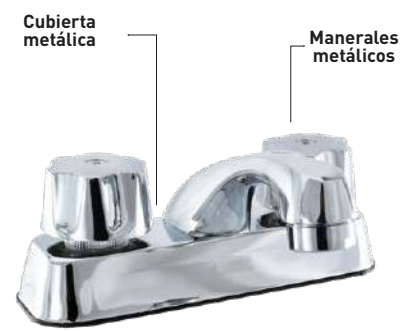

CÓDIGO	DESCRIPCIÓN	PRECIO	INNER	MASTER
MEZL696	Cromado	\$ 340.00	1	20

**Mezcladora lavabo**  
Cuerpo de plástico



Cartucho de compresión V3012  
 1/4 de vuelta  
 Presión baja  
 Caja a color

CÓDIGO	DESCRIPCIÓN	PRECIO	INNER	MASTER
MEZL4550	Cromado	\$ 170.00	1	16

**Mezcladora lavabo**  
Cuerpo de latón



Cartuchos cerámicos V3019  
 1/4 de vuelta  
 Presión baja  
 NMX  
 Caja a color

CÓDIGO	DESCRIPCIÓN	PRECIO	INNER	MASTER
MEZL792C	Cromado	\$ 395.00	1	20

**Mezcladora lavabo**  
Cuerpo de latón

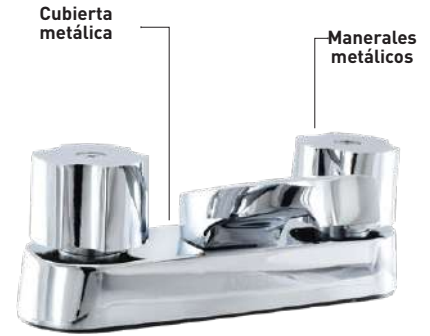

Cartuchos de compresión V3055  
 Vuelta completa  
 Presión baja  
 NMX  
 Caja a color

CÓDIGO	DESCRIPCIÓN	PRECIO	INNER	MASTER
MEZL4084	Cromado	\$ 395.00	1	20

**Mezcladora lavabo**  
Cuerpo de latón

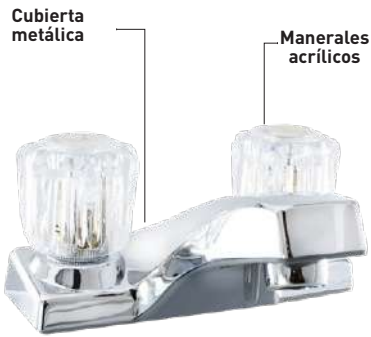

Cartuchos cerámicos V3010  
 1/4 de vuelta  
 Presión baja  
 Caja a color

CÓDIGO	DESCRIPCIÓN	PRECIO	INNER	MASTER
MEZL117	Cromado	\$ 440.00	1	20

**Mezcladora lavabo**  
Cuerpo de latón



Cartuchos de compresión V3067  
 Vuelta completa  
 Presión baja  
 NMX  
 Caja a color

CÓDIGO	DESCRIPCIÓN	PRECIO	INNER	MASTER
MEZL794C	Cromado	\$ 430.00	1	20

**Mezcladora lavabo**  
Cuerpo de latón



Cartuchos cerámicos V3073  
 1/4 de vuelta  
 Presión baja  
 Caja a color

CÓDIGO	DESCRIPCIÓN	PRECIO	INNER	MASTER
MEZL121	Cromado	\$ 560.00	1	20

**Mezcladora lavabo**  
Cuerpo de latón



Cartuchos cerámicos V3071  
 1/4 de vuelta  
 Presión baja  
 NMX  
 Caja a color

CÓDIGO	DESCRIPCIÓN	PRECIO	INNER	MASTER
MEZL4202	Cromado	\$ 490.00	1	20

**Mezcladora lavabo**  
Cuerpo de latón

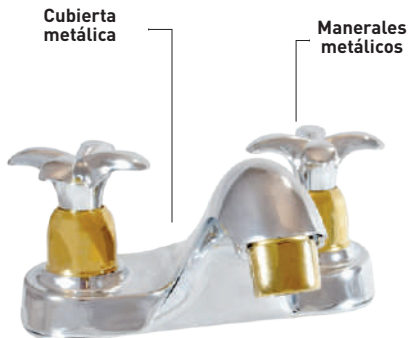

Cartuchos cerámicos V3037  
 1/4 de vuelta  
 Presión baja  
 NMX  
 Caja a color

CÓDIGO	DESCRIPCIÓN	PRECIO	INN.	MAS.
MEZL4202KCP2	Cromado/Dorado	\$ 550.00	1	20

**Mezcladora lavabo**  
Cuerpo de latón



Cartuchos cerámicos V3036  
 1/4 de vuelta  
 Presión baja  
 NMX  
 Caja a color

CÓDIGO	DESCRIPCIÓN	PRECIO	INNER	MASTER
MEZL4203	Cromado	\$ 580.00	1	20



## Mezcladora lavabo Cuerpo de latón



CÓDIGO	DESCRIPCIÓN	PRECIO	INNER	MASTER
MEZL8030	Cromado/Dorado	\$ 610.00	1	20

## Mezcladora lavabos Cuerpo de latón



CÓDIGO	DESCRIPCIÓN	PRECIO	INNER	MASTER
MEZL8030BN	Níquel pulido	\$ 722.00	1	20

## Mezcladora lavabos Cuerpo de latón



CÓDIGO	DESCRIPCIÓN	PRECIO	INNER	MASTER
MEZL1760	Níquel pulido	\$ 630.00	1	24

## Mezcladora lavabos Cuerpo de latón



CÓDIGO	DESCRIPCIÓN	PRECIO	INNER	MASTER
MEZL4036	Cromado/Blanco	\$ 550.00	1	20

## Mezcladora lavabos Cuerpo de latón



CÓDIGO	DESCRIPCIÓN	PRECIO	INNER	MASTER
MEZL8032	Cromado/Dorado	\$ 600.00	1	20

## Mezcladora lavabos Cuerpo de latón



CÓDIGO	DESCRIPCIÓN	PRECIO	INNER	MASTER
MEZTY848CK	Cromado/Dorado	\$ 660.00	1	20

## Mezcladora lavabos Cuerpo de latón



CÓDIGO	DESCRIPCIÓN	PRECIO	INNER	MASTER
MEZL8027	Cromado/Dorado	\$ 600.00	1	20

## Mezcladora lavabos Cuerpo de latón



CÓDIGO	DESCRIPCIÓN	PRECIO	INNER	MASTER
MEZL8028C	Cromado	\$ 620.00	1	20

## Mezcladora lavabos Cuerpo de latón



CÓDIGO	DESCRIPCIÓN	PRECIO	INNER	MASTER
MEZL8024	Cromado/Satín	\$ 710.00	1	20

**Mezcladora lavabo**  
Cuerpo de latón



<b>CÓDIGO</b>	<b>DESCRIPCIÓN</b>	<b>PRECIO</b>	<b>INNER</b>	<b>MASTER</b>
MEZL8045	Cromado	\$ 600.00	1	20

**Mezcladora lavabo**  
Cuerpo de latón



<b>CÓDIGO</b>	<b>DESCRIPCIÓN</b>	<b>PRECIO</b>	<b>INNER</b>	<b>MASTER</b>
MEZL8042	Cromado	\$ 680.00	1	12

**Mezcladora lavabo**  
Cuerpo de latón



<b>CÓDIGO</b>	<b>DESCRIPCIÓN</b>	<b>PRECIO</b>	<b>INNER</b>	<b>MASTER</b>
MEZL8041	Dorado	\$ 820.00	1	12

**Mezcladora lavabo**  
Cuerpo de latón



<b>CÓDIGO</b>	<b>DESCRIPCIÓN</b>	<b>PRECIO</b>	<b>INNER</b>	<b>MASTER</b>
MEZL8041BN	Níquel pulido	\$ 765.00	1	12

**Mezcladora lavabo**  
Cuerpo de latón

Producto **NUEVO**



<b>CÓDIGO</b>	<b>DESCRIPCIÓN</b>	<b>PRECIO</b>	<b>INNER</b>	<b>MASTER</b>
ABML1924	Cromado	\$ 625.00	1	20

**Mezcladora lavabo**  
Cuerpo de latón



<b>CÓDIGO</b>	<b>DESCRIPCIÓN</b>	<b>PRECIO</b>	<b>INNER</b>	<b>MASTER</b>
MEZ0403CBH8	Cromado/Dorado	\$ 640.00	1	20

**Mezcladora lavabo**  
Cuerpo de latón



<b>CÓDIGO</b>	<b>DESCRIPCIÓN</b>	<b>PRECIO</b>	<b>INNER</b>	<b>MASTER</b>
MEZL0403C	Cromado	\$ 690.00	1	20

**Mezcladora lavabo**  
Cuerpo de latón



<b>CÓDIGO</b>	<b>DESCRIPCIÓN</b>	<b>PRECIO</b>	<b>INNER</b>	<b>MASTER</b>
MEZL0403BN	Níquel pulido	\$ 1,026.00	1	12

## Mezcladora lavabo Cuerpo de latón



CÓDIGO	DESCRIPCIÓN	PRECIO	INNER	MASTER
MEZL0404CBH6	Cromado/Dorado	\$ 690.00	1	20

## Mezcladora lavabo Cuerpo de latón



CÓDIGO	DESCRIPCIÓN	PRECIO	INNER	MASTER
MEZL8040	Cromado/Dorado	\$ 950.00	1	12

## Mezcladora lavabo Cuerpo de latón



CÓDIGO	DESCRIPCIÓN	PRECIO	INNER	MASTER
MEZL4060C	Cromado	\$ 685.00	1	20

## Mezcladora lavabo Cuerpo de latón



CÓDIGO	DESCRIPCIÓN	PRECIO	INNER	MASTER
MEZL4059BN	Níquel pulido	\$ 905.00	1	20

## Mezcladora lavabo Cuerpo de latón

Producto **NUEVO**



CÓDIGO	DESCRIPCIÓN	PRECIO	INNER	MASTER
ABML1925	Cromado	\$ 590.00	1	20

## Mezcladora lavabo Cuerpo de latón

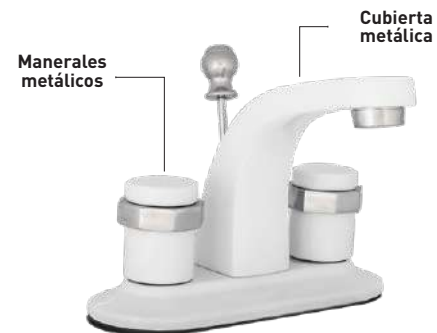

CÓDIGO	DESCRIPCIÓN	PRECIO	INNER	MASTER
MEZTY846	Blanco/Satín	\$ 860.00	1	15

**Mezcladora monomando para lavabo**

Conexiones de latón y cobre

Incluye: contra para lavabo



CÓDIGO	DESCRIPCIÓN	PRECIO	INNER	MASTER
MEZL120	Cromado	\$ 795.00	1	12

**Mezcladora monomando para lavabo**  
Cuerpo de latón



CÓDIGO	DESCRIPCIÓN	PRECIO	INNER	MASTER
MEZL697	Cromado	\$ 500.00	1	20

**Mezcladora monomando para lavabo**

Conexiones de latón y cobre

Incluye: contra para lavabo



CÓDIGO	DESCRIPCIÓN	PRECIO	INNER	MASTER
MEZL119	Cromado	\$ 795.00	1	12

**Mezcladora monomando para lavabo**

Conexiones de latón y cobre

Incluye: contra para lavabo



CÓDIGO	DESCRIPCIÓN	PRECIO	INNER	MASTER
MEZL119BN	Níquel pulido	\$ 990.00	1	12

**Llave temporizadora individual para lavabo**

Cuerpo de latón



CÓDIGO	DESCRIPCIÓN	PRECIO	INNER	MASTER
MEZL112	Cromado	\$ 400.00	1	40

**Llave temporizadora individual para lavabo**

Cuerpo de latón



CÓDIGO	DESCRIPCIÓN	PRECIO	INNER	MASTER
MEZL1473	Cromado	\$ 650.00	1	40

**Llave individual para lavabo**

Cuerpo de latón

Tiempo de cierre: 5 a 13 s



CÓDIGO	DESCRIPCIÓN	PRECIO	INNER	MASTER
ABLP1910	Cromado	\$ 600.00	1	12

**Mezcladora lavabo**

Cuerpo de latón

Llave electrónica con sensor de movimiento  
Opera por medio de baterías (DC) o corriente a 120 volts



Ahorro de agua



CÓDIGO	DESCRIPCIÓN	PRECIO	INNER	MASTER
MEZLS1045	Cromado	\$ 3,300.00	1	10

El aspecto, empaque, inner o master de los productos puede variar sin previo aviso debido a la innovación continua de nuestras marcas.

## Mezcladora lavabo

Tipo bar  
Cuerpo de latón



CÓDIGO	DESCRIPCIÓN	PRECIO	INNER	MASTER
MEZB1080	Cromado	\$ 270.00	1	20

## Mezcladora lavabo

Tipo bar  
Cuerpo de latón

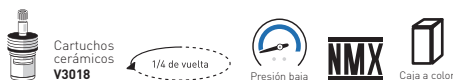

CÓDIGO	DESCRIPCIÓN	PRECIO	INNER	MASTER
MEZB1090	Cromado	\$ 270.00	1	20

## Mezcladora lavabo

Tipo bar  
Cuerpo de latón

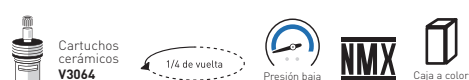

CÓDIGO	DESCRIPCIÓN	PRECIO	INNER	MASTER
MEZB470	Cromado	\$ 320.00	1	24

## Mezcladora lavabo

Tipo bar  
Cuerpo de latón



CÓDIGO	DESCRIPCIÓN	PRECIO	INNER	MASTER
MEZB107A	Cromado	\$ 325.00	1	24

## Mezcladora lavabo

Tipo bar  
Cuerpo de latón



CÓDIGO	DESCRIPCIÓN	PRECIO	INNER	MASTER
MEZB4003	Cromado	\$ 340.00	1	24

## Mezcladora lavabo

Tipo bar  
Cuerpo de latón



CÓDIGO	DESCRIPCIÓN	PRECIO	INNER	MASTER
MEZB469	Cromado	\$ 385.00	1	20

## Mezcladora lavabo

Tipo bar  
Cuerpo de latón



CÓDIGO	DESCRIPCIÓN	PRECIO	INNER	MASTER
MEZB4096	Cromado	\$ 390.00	1	24

## Mezcladora lavabo

Tipo bar  
Cuerpo de latón



CÓDIGO	DESCRIPCIÓN	PRECIO	INNER	MASTER
MEZB107	Cromado	\$ 400.00	1	20

## Mezcladora lavabo

Tipo bar  
Cuerpo de latón



CÓDIGO	DESCRIPCIÓN	PRECIO	INNER	MASTER
MEZB4065C	Cromado	\$ 400.00	1	24

**Mezcladora lavabo**

Tipo bar  
Cuerpo de latón



Cartuchos cerámicos V3020  
 1/4 de vuelta  
 Presión baja  
 Caja a color

CÓDIGO	DESCRIPCIÓN	PRECIO	INNER	MASTER
MEZB4065BN	Níquel pulido	\$ 496.00	1	24

**Mezcladora lavabo**

Tipo bar  
Cuerpo de latón

Producto **NUEVO**



Cartuchos cerámicos  
 1/4 de vuelta  
 Presión baja  
 Caja a color

CÓDIGO	DESCRIPCIÓN	PRECIO	INNER	MASTER
ABML1923	Cromado	\$ 415.00	1	20

**Mezcladora lavabo**

Tipo bar  
Cuerpo de latón



Cartuchos cerámicos V3018  
 1/4 de vuelta  
 Presión baja  
 Caja a color

CÓDIGO	DESCRIPCIÓN	PRECIO	INNER	MASTER
MEZB8029	Cromado/Dorado	\$ 415.00	1	24

**Mezcladora lavabo**

Tipo bar  
Cuerpo de latón



Cartuchos cerámicos V3034  
 1/4 de vuelta  
 Presión baja  
 Caja a color

CÓDIGO	DESCRIPCIÓN	PRECIO	INNER	MASTER
MEZB8025BN	Níquel pulido	\$ 600.00	1	24

**Mezcladora lavabo**

Tipo bar  
Cuerpo de latón



Cartuchos cerámicos V3031  
 1/4 de vuelta  
 Presión baja  
 Caja a color

CÓDIGO	DESCRIPCIÓN	PRECIO	INNER	MASTER
MEZL1806	Cromado	\$ 420.00	1	20

**Mezcladora lavabo**

Tipo bar  
Cuerpo de latón



Cartuchos cerámicos V3034  
 1/4 de vuelta  
 Presión baja  
 Caja a color

CÓDIGO	DESCRIPCIÓN	PRECIO	INNER	MASTER
MEZB107KCP2	Cromado/Dorado	\$ 430.00	1	24

**Mezcladora lavabo**

Tipo bar  
Cuerpo de latón



Cartuchos cerámicos V3063  
 1/4 de vuelta  
 Presión baja  
 Caja a color

CÓDIGO	DESCRIPCIÓN	PRECIO	INNER	MASTER
MEZB993	Cromado	\$ 430.00	1	24

**Mezcladora lavabo**

Tipo bar  
Cuerpo de latón



Cartuchos cerámicos V3041  
 1/4 de vuelta  
 Presión baja  
 Caja a color

CÓDIGO	DESCRIPCIÓN	PRECIO	INNER	MASTER
MEZB1759	Cromado	\$ 430.00	1	24

## Mezcladora lavabo

Tipo bar

Cuerpo de latón



CÓDIGO	DESCRIPCIÓN	PRECIO	INNER	MASTER
MEZB4136	Cromado	\$ 430.00	1	12

## Mezcladora lavabo

Tipo bar

Cuerpo de latón



CÓDIGO	DESCRIPCIÓN	PRECIO	INNER	MASTER
MEZB4140	Cromado	\$ 430.00	1	12

## Mezcladora lavabo

Tipo bar

Cuerpo de latón



CÓDIGO	DESCRIPCIÓN	PRECIO	INNER	MASTER
MEZB1644	Cromado	\$ 450.00	1	20

## Mezcladora lavabo

Tipo bar

Cuerpo de latón

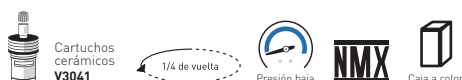

CÓDIGO	DESCRIPCIÓN	PRECIO	INNER	MASTER
MEZB1645	Cromado	\$ 450.00	1	20

## Mezcladora lavabo

Tipo bar

Cuerpo de latón

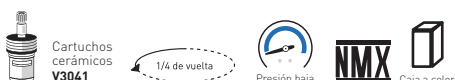

CÓDIGO	DESCRIPCIÓN	PRECIO	INNER	MASTER
MEZB1646	Cromado	\$ 450.00	1	20

## Mezcladora lavabo

Tipo bar

Cuerpo de latón

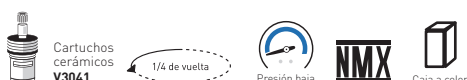

CÓDIGO	DESC.	PRECIO	INNER	MASTER
MEZL791C	Cromado	\$ 495.00	1	20

## Mezcladora lavabo

Tipo bar

Cuerpo de latón

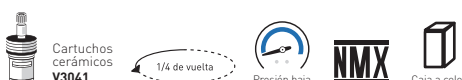

CÓDIGO	DESC.	PRECIO	INNER	MASTER
MEZL791BN	Níquel pulido	\$ 625.00	1	20

## Mezcladora lavabo

Tipo bar

Cuerpo de latón

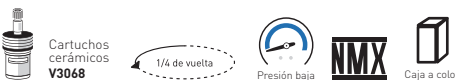

CÓDIGO	DESCRIPCIÓN	PRECIO	INN.	MAS.
MEZL4206C	Cromado	\$ 670.00	1	12

## Mezcladora lavabo

Tipo bar

Cuerpo de latón

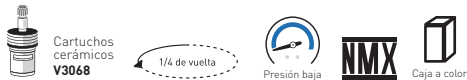

CÓDIGO	DESCRIPCIÓN	PRECIO	INN.	MAS.
MEZL4206BN	Níquel pulido	\$ 770.00	1	20

**Mezcladora lavabo**

Tipo bar

Cuerpo de latón

Cubierta metálica



Manerales metálicos



CÓDIGO	DESCRIPCIÓN	PRECIO	INNER	MASTER
MEZL4207C	Cromado	\$ 670.00	1	24

**Mezcladora lavabo**

Tipo bar

Cuerpo de latón

Cubierta metálica



Manerales metálicos



CÓDIGO	DESCRIPCIÓN	PRECIO	INNER	MASTER
MEZL4207BN	Níquel pulido	\$ 770.00	1	20

**Mezcladora monomando para lavabo**

Cuerpo de latón

Maneral metálico



Altura 190 mm

Recubrimiento metálico



CÓDIGO	DESCRIPCIÓN	PRECIO	INNER	MASTER
MEZL139C	Cromado	\$ 560.00	1	20

**Mezcladora monomando para lavabo**

Cuerpo de latón

Maneral metálico



Altura 300 mm

Recubrimiento metálico



CÓDIGO	DESCRIPCIÓN	PRECIO	INNER	MASTER
MEZL140C	Cromado	\$ 750.00	1	24

**Mezcladora monomando para lavabo**

Cuerpo de latón

Producto NUEVO

Maneral metálico



Altura 170 mm

Recubrimiento metálico

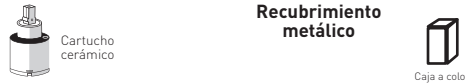

CÓDIGO	DESCRIPCIÓN	PRECIO
ANMM1789	Cromado	\$ 1,150.00

**Mezcladora monomando para lavabo**

Cuerpo de latón

Producto NUEVO

Maneral metálico



Altura 300 mm

Recubrimiento metálico



CÓDIGO	DESCRIPCIÓN	PRECIO
ANMM1788	Cromado	\$ 1,650.00

**Mezcladora monomando para lavabo**

Cuerpo de latón

Producto NUEVO

Maneral metálico



Altura 160 mm

Recubrimiento metálico

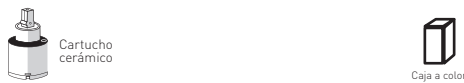

CÓDIGO	DESCRIPCIÓN	PRECIO
ANMM1787	Cromado	\$ 750.00

**Mezcladora monomando para lavabo**

Cuerpo de latón

Producto NUEVO

Maneral metálico



Altura 290 mm

Recubrimiento metálico



CÓDIGO	DESCRIPCIÓN	PRECIO
ANMM1786	Cromado	\$ 900.00

**Mezcladora monomando para lavabo**

Cuerpo de latón

Producto NUEVO

Maneral metálico



Altura 160 mm

Recubrimiento metálico



CÓDIGO	DESCRIPCIÓN	PRECIO
ANMM1791	Cromado	\$ 1,200.00



## Mezcladora monomando para lavabo

Cuerpo de latón

Producto **NUEVO**



CÓDIGO	DESCRIPCIÓN	PRECIO
ANMM1790	Cromado	\$ 1,650.00

## Mezcladora monomando para lavabo

Cuerpo de latón



CÓDIGO	DESCRIPCIÓN	PRECIO	INNER	MASTER
MEZL135C	Cromado	\$ 1,980.00	1	12

## Mezcladora monomando para lavabo

Cuerpo de latón



CÓDIGO	DESCRIPCIÓN	PRECIO	INNER	MASTER
MEZL136BN	Níquel pulido	\$ 2,170.00	1	12

## Mezcladora monomando para lavabo

Cuerpo de latón



CÓDIGO	DESCRIPCIÓN	PRECIO	INNER	MASTER
MEZL137C	Cromado	\$ 2,034.00	1	12

## Mezcladora monomando para lavabo

Cuerpo de latón



CÓDIGO	DESCRIPCIÓN	PRECIO	INNER	MASTER
MEZL138BN	Níquel pulido	\$ 2,196.00	1	12

## Mezcladora lavabo

Cuerpo de latón



CÓDIGO	DESCRIPCIÓN	PRECIO	INNER	MASTER
MEZF8060	Cromado	\$ 1,800.00	1	15

## Mezcladora monomando para lavabo

Cuerpo de latón

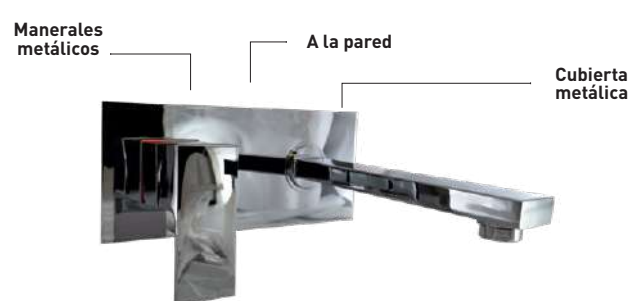

CÓDIGO	DESCRIPCIÓN	PRECIO	INNER	MASTER
MEZF1762	Cromado	\$ 2,150.00	1	12

**Mezcladora lavabo**  
Cuerpo de latón

Incluye: Contra para lavabo



CÓDIGO	DESCRIPCIÓN	PRECIO	INNER	MASTER
MEZTS6059C	Cromado	\$ 2,000.00	1	6

**Mezcladora lavabo**  
Cuerpo de latón

Incluye: Contra para lavabo



CÓDIGO	DESCRIPCIÓN	PRECIO	INNER	MASTER
MEZTS6059BN	Níquel pulido	\$ 2,350.00	1	6

**Mezcladora lavabo**  
Cuerpo de latón

Incluye: Contra para lavabo



CÓDIGO	DESCRIPCIÓN	PRECIO	INNER	MASTER
MEZTS6027	Cromado	\$ 2,100.00	1	6

**Mezcladora lavabo**  
Cuerpo de latón

Incluye: Contra para lavabo



CÓDIGO	DESC.	PRECIO	INN.	MAS.
MEZTS6012	Cromado	\$ 2,100.00	1	6

**Mezcladora lavabo**  
Cuerpo de latón



Incluye: Contra para lavabo



CÓDIGO	DESC.	PRECIO	INN.	MAS.
MEZTS6018CG	Cromado/Dorado	\$ 2,100.00	1	6

**Mezcladora lavabo**  
Cuerpo de latón



CÓDIGO	DESCRIPCIÓN	PRECIO	INNER	MASTER
MEZTS456C	Cromado	\$ 2,400.00	1	6

**Mezcladora lavabo**  
Cuerpo de latón



CÓDIGO	DESCRIPCIÓN	PRECIO	INNER	MASTER
MEZTS456BN	Níquel pulido	\$ 2,600.00	1	6

**GAETTA**  
ONE PIECE  
Cuerpo de cerámica

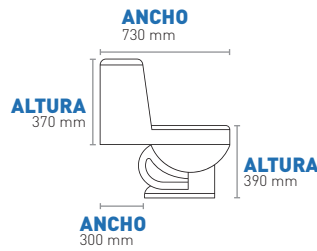

**Especificaciones**  
-Trampa expuesta  
-Incluye asiento y cubretornillos

CÓDIGO	DESCRIPCIÓN	PRECIO	INNER	MASTER
ABSV1817	Color blanco	\$ 3,000.00	1	1

**SANTORO**  
ONE PIECE  
Cuerpo de cerámica

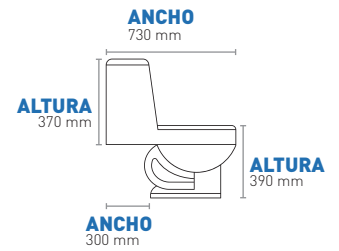

**Especificaciones**  
-Trampa expuesta  
-Incluye asiento y cubretornillos

CÓDIGO	DESCRIPCIÓN	PRECIO	INNER	MASTER
ABSV1910	Color beige	\$ 3,500.00	1	1

**VARENNA**  
ONE PIECE  
Cuerpo de cerámica

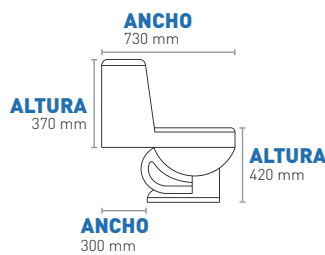

**Especificaciones**  
-Trampa expuesta  
-Incluye asiento y cubretornillos

CÓDIGO	DESCRIPCIÓN	PRECIO	INNER	MASTER
ABSV1818	Color blanco	\$ 3,000.00	1	1

**TRENTO**  
ONE PIECE  
Cuerpo de cerámica

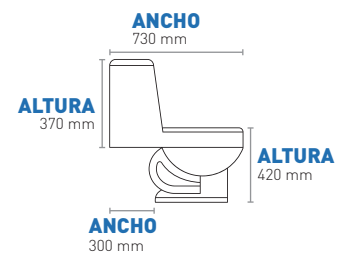

**Especificaciones**  
-Trampa expuesta  
-Incluye asiento y cubretornillos

CÓDIGO	DESCRIPCIÓN	PRECIO	INNER	MASTER
ABSV1911	Color beige	\$ 3,500.00	1	1

**Mingitorio Lipari**  
Cuerpo de cerámica

Tipo cascada  
Conexión a la descarga 1"  
No incluye fluxómetro  
No incluye céspol

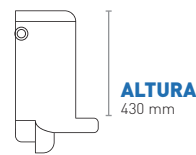

CÓDIGO	DESCRIPCIÓN	PRECIO	INNER	MASTER
ABMI1828	Porcelanizado alto brillo	\$ 2,400.00	1	1

**Mingitorio Simonetta**  
Cuerpo de cerámica

Tipo cascada  
Conexión a la descarga 1"  
No incluye fluxómetro  
Incluye céspol



VISTA EN PLANTA

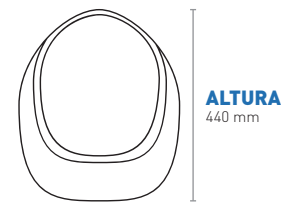

CÓDIGO	DESCRIPCIÓN	PRECIO	INNER	MASTER
ABMI1827	Porcelanizado alto brillo	\$ 1,500.00	1	1

El aspecto, empaque, inner o master de los productos puede variar sin previo aviso debido a la innovación continua de nuestras marcas.

**Ovalín modelo Vernazza**

Cuerpo de cerámica

Lavabo de sobrecubierta

Peso: 7.5 Kg.

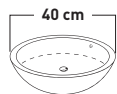

PROFUNDIDAD 17 cm



Caja a color

**Ovalín modelo Glorena**

Cuerpo de cerámica

Lavabo de sobrecubierta

Peso: 7 Kg.



PROFUNDIDAD 15.5 cm



Caja a color

**Ovalín modelo Dozza**

Cuerpo de cerámica

Lavabo de sobrecubierta

Peso: 8 Kg

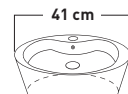

PROFUNDIDAD 14.5 cm



Para mueble montanari



Para mezcladora monomando



Caja a color

CÓDIGO	DESCRIPCIÓN	PRECIO	INNER	MASTER
ABOV1819	Anti-rayaduras	\$ 1,125.00	1	1

CÓDIGO	DESCRIPCIÓN	PRECIO	INNER	MASTER
ABOV1824	Anti-rayaduras	\$ 1,152.00	1	1

CÓDIGO	DESCRIPCIÓN	PRECIO	INNER	MASTER
ABOV1826	Anti-rayaduras	\$ 1,170.00	1	1

**Ovalín modelo Atrani**

Cuerpo de cerámica

Lavabo de sobrecubierta

Peso: 12 Kg

Rebosadero posterior

PROFUNDIDAD 14.5 cm



Para mueble volterra



Para mezcladora monomando



Caja a color

**Ovalín modelo Mantova**

Cuerpo de cerámica

Lavabo de sobrecubierta

Peso: 9 Kg

Rebosadero posterior.

PROFUNDIDAD 13.5 cm

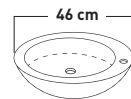

Para mezcladora monomando



Caja a color

CÓDIGO	DESCRIPCIÓN	PRECIO	INNER	MASTER
ABOV1823	Anti-rayaduras	\$ 1,300.00	1	1

CÓDIGO	DESCRIPCIÓN	PRECIO	INNER	MASTER
ABOV1821	Anti-rayaduras	\$ 1,400.00	1	1

**Ovalín modelo Biella**

Cuerpo de cerámica

Lavabo de sobrecubierta

Peso: 17 Kg

PROFUNDIDAD 16 cm

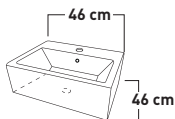

Para mueble sabetta



Para mezcladora monomando



Caja a color

**Ovalín modelo Misurina**

Cuerpo de cerámica

Lavabo de sobrecubierta

Peso: 21 Kg

PROFUNDIDAD 15 cm

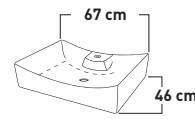

Para mueble montanari



Para mezcladora monomando



Caja a color

CÓDIGO	DESCRIPCIÓN	PRECIO	INNER	MASTER
ABOV1825	Anti-rayaduras	\$ 2,000.00	1	1

CÓDIGO	DESCRIPCIÓN	PRECIO	INNER	MASTER
ABOV1822	Anti-rayaduras	\$ 2,160.00	1	1

## Combo lavabo Atrani

Los combos incluyen:

Mueble: **Volterra**

Ovalín Atrani: **ABOV1823**

Espejo ( mismo acabado del mueble )

Largo: **52 cm**, Alto: **60 cm** y Profundidad: **1.6 cm**

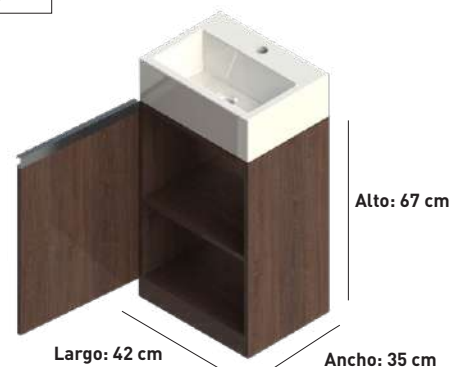
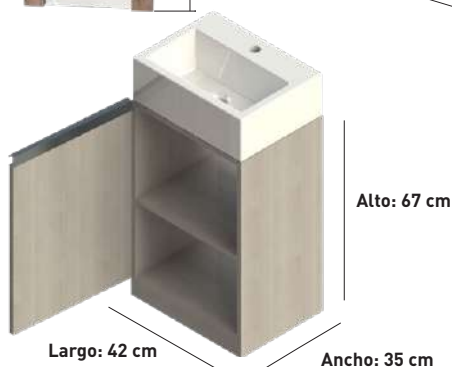
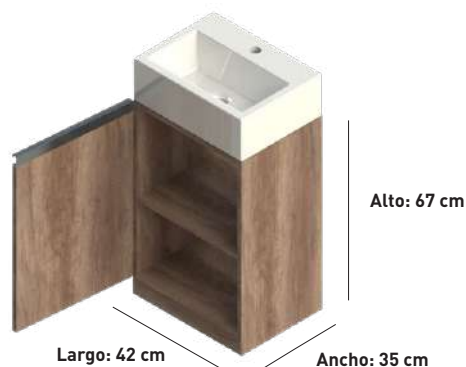
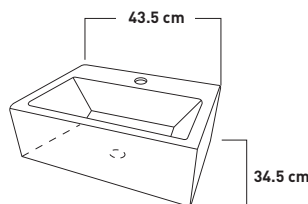
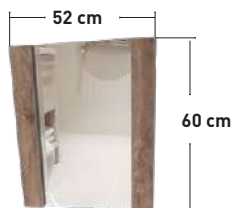

Mueble exclusivo para venta en combo.



Mueble exclusivo para venta en combo.



Mueble exclusivo para venta en combo.

CÓDIGO	DESCRIPCIÓN	PRECIO
ABM01895	Nebraska	\$ 4,500.00

CÓDIGO	DESCRIPCIÓN	PRECIO
ABM01896	Ceniza	\$ 4,500.00

CÓDIGO	DESCRIPCIÓN	PRECIO
ABM01897	Roble tabaco	\$ 4,500.00

## Combo lavabo Atrani + kit de herrajes

Los combos incluyen:

Mueble: **Volterra**

Ovalín Atrani: **ABOV1823**

Espejo ( mismo acabado del mueble )



Incluye kit de herrajes:

Mezcladora: **MEZL139C**

Dos llaves de retención: **LLARAVCR**

Dos alimentadores: **ALILV55**

Contra rejilla: **CONLCZ**

Césped: **TRAL431**

Conector céspol: **CONC114**



CÓDIGO	DESCRIPCIÓN	PRECIO
ABM01834	Nebraska	\$ 5,400.00

CÓDIGO	DESCRIPCIÓN	PRECIO
ABM01835	Ceniza	\$ 5,400.00

CÓDIGO	DESCRIPCIÓN	PRECIO
ABM01836	Roble tabaco	\$ 5,400.00

**Combo lavabo Dozza**

Los combos incluyen:

Mueble: **Montanari**

Ovalín Dozza: **ABOV1826**

Espejo ( mismo acabado del mueble )

Largo: **52 cm**, Alto: **60 cm** y Profundidad: **1.6 cm**

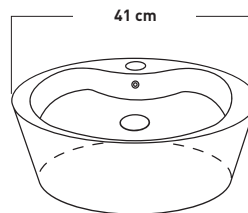
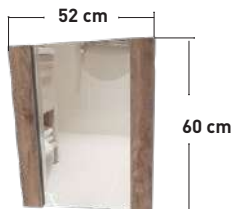

Alto: 69.5 cm

Largo: 63 cm

Ancho: 43 cm



Alto: 69.5 cm

Largo: 63 cm

Ancho: 43 cm



Alto: 69.5 cm

Largo: 63 cm

Ancho: 43 cm



Exclusivo para Ovalín Dozza en compra de combo.



Exclusivo para Ovalín Dozza en compra de combo.



Exclusivo para Ovalín Dozza en compra de combo.



CÓDIGO	DESCRIPCIÓN	PRECIO
ABM01898	Nebraska	\$ 4,500.00

CÓDIGO	DESCRIPCIÓN	PRECIO
ABM01899	Ceniza	\$ 4,500.00

CÓDIGO	DESCRIPCIÓN	PRECIO
ABM01900	Roble tabaco	\$ 4,500.00

**Combo lavabo Dozza + kit de herrajes**

Los combos incluyen:

Mueble: **Montanari**

Ovalín Dozza: **ABOV1826**

Espejo ( mismo acabado del mueble )



Incluye kit de herrajes:

Mezcladora: **MEZL139C**

Dos llaves de retención: **LLARAVCR**

Dos alimentadores: **ALILV55**

Contra rejilla: **CONLCZ**

Céspol: **TRAL431**

Conector céspol: **CONC114**

Largo 52 cm

Largo 52 cm

Largo 52 cm



Alto: 60 cm



Alto: 60 cm



Alto: 60 cm



Alto: 69.5 cm

Largo: 63 cm

Ancho: 43 cm



Alto: 69.5 cm

Largo: 63 cm

Ancho: 43 cm



Alto: 69.5 cm

Largo: 63 cm

Ancho: 43 cm

CÓDIGO	DESCRIPCIÓN	PRECIO
ABM01837	Nebraska	\$ 5,480.00

CÓDIGO	DESCRIPCIÓN	PRECIO
ABM01838	Ceniza	\$ 5,480.00

CÓDIGO	DESCRIPCIÓN	PRECIO
ABM01839	Roble tabaco	\$ 5,480.00

## Combo lavabo Biella

Los combos incluyen:

Mueble: **Sabetta**

Ovalín Biella: **ABOV1825**

Espejo ( mismo acabado del mueble )

Largo: **52 cm**, Alto: **60 cm** y Profundidad: **1.6 cm**

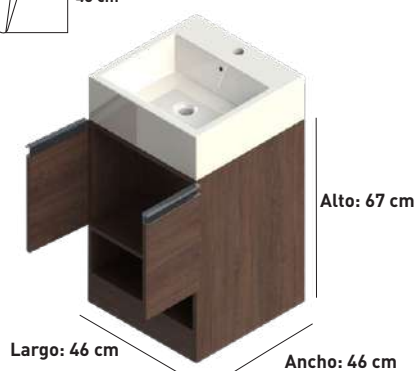
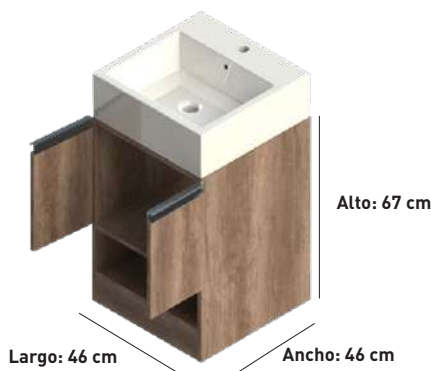
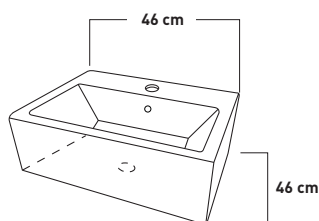
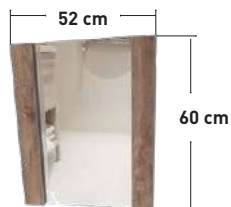

Mueble exclusivo para venta en combo.



Mueble exclusivo para venta en combo.



Mueble exclusivo para venta en combo.

CÓDIGO	DESCRIPCIÓN	PRECIO
ABM01901	Nebraska	\$ 5,525.00

CÓDIGO	DESCRIPCIÓN	PRECIO
ABM01902	Ceniza	\$ 5,525.00

CÓDIGO	DESCRIPCIÓN	PRECIO
ABM01903	Roble tabaco	\$ 5,525.00

## Combo lavabo Biella + kit de herrajes

Los combos incluyen:

Mueble: **Sabetta**

Ovalín Biella: **ABOV1825**

Espejo ( mismo acabado del mueble )



Incluye kit de herrajes:

Mezcladora: **MEZL139C**

Dos llaves de retención: **LLARAVCR**

Dos alimentadores: **ALILV55**

Contra rejilla: **CONLCZ**

Césped: **TRAL431**

Conector céspol: **CONC114**



CÓDIGO	DESCRIPCIÓN	PRECIO
ABM01840	Nebraska	\$ 6,400.00

CÓDIGO	DESCRIPCIÓN	PRECIO
ABM01841	Ceniza	\$ 6,400.00

CÓDIGO	DESCRIPCIÓN	PRECIO
ABM01842	Roble tabaco	\$ 6,400.00

**Combo lavabo Misurina**

Los combos incluyen:

Mueble: **Rocatto**

Ovalín Misurina: **ABOV1822**

Espejo ( mismo acabado del mueble )

Largo: **52 cm**, Alto: **60 cm** y Profundidad: **1.6 cm**

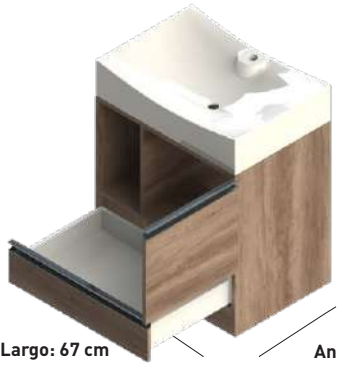
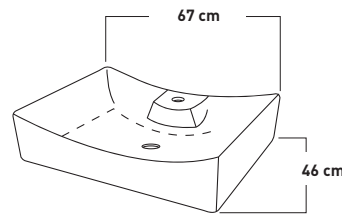
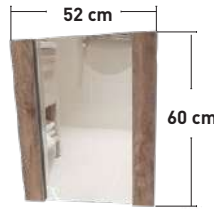

Largo: 67 cm

Ancho: 46 cm

Alto: 67.5 cm

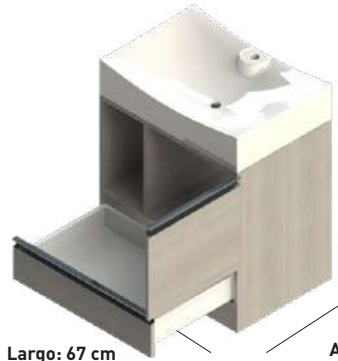

Largo: 67 cm

Ancho: 46 cm

Alto: 67.5 cm

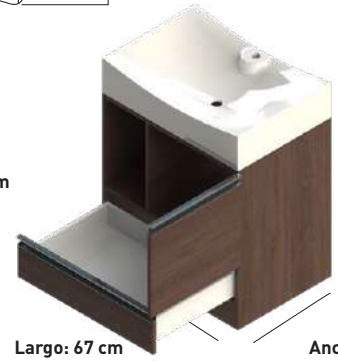

Largo: 67 cm

Ancho: 46 cm

Alto: 67.5 cm



Mueble exclusivo para venta en combo.



Mueble exclusivo para venta en combo.



Mueble exclusivo para venta en combo.

CÓDIGO	DESCRIPCIÓN	PRECIO
ABM01904	Nebraska	\$ 6,300.00

CÓDIGO	DESCRIPCIÓN	PRECIO
ABM01905	Ceniza	\$ 6,300.00

CÓDIGO	DESCRIPCIÓN	PRECIO
ABM01906	Roble tabaco	\$ 6,300.00

**Combo lavabo Misurina + kit de herrajes**

Los combos incluyen:

Mueble: **Rocatto**

Ovalín Misurina: **ABOV1822**

Espejo ( mismo acabado del mueble )

Largo 52 cm



Largo 52 cm

Incluye kit de herrajes:

Mezcladora: **MEZL139C**

Dos llaves de retención: **LLARAVCR**

Dos alimentadores: **ALILV55**

Contra rejilla: **CONLCZ**

Céspol: **TRAL431**

Conector céspol: **CONC114**



CÓDIGO	DESCRIPCIÓN	PRECIO
ABM01843	Nebraska	\$ 7,500.00

CÓDIGO	DESCRIPCIÓN	PRECIO
ABM01844	Ceniza	\$ 7,500.00

CÓDIGO	DESCRIPCIÓN	PRECIO
ABM01845	Roble tabaco	\$ 7,500.00

El aspecto, empaque, inner o master de los productos puede variar sin previo aviso debido a la innovación continua de nuestras marcas.



**Combo lavabo Vernazza**

El combo Vernaza incluye:  
Mueble: **Montanari** tabaco  
Ovalín Vernazza: **ABOV1819**  
Espejo ( Acabado tabaco )



Exclusivo en compra de combo.

CÓDIGO	DESCRIPCIÓN	PRECIO
ABM01907	Tabaco	\$ 4,500.00

**Combo lavabo Vernazza + kit de herrajes**

El combo incluye:  
Mueble: **Montanari** tabaco  
Ovalín Vernazza: **ABOV1819**  
Espejo ( Acabado tabaco )  
Largo: 52 cm, Alto: 60 cm y Profundidad: 1.6 cm

**kit de herrajes:**  
Mezcladora: MEZL140C  
Dos llaves de retención: LLARAVCR  
Dos alimentadores: ALILV55  
Contra rejilla: CONLCZ  
Céspol: TRAL431  
Conector céspol: CONC114



CÓDIGO	DESCRIPCIÓN	PRECIO
ABM01892	Tabaco	\$ 5,600.00

**Combo lavabo Glorena**

El combo Glorena incluye:  
Mueble: **Montanari** ceniza  
Ovalín Glorena: **ABOV1824**  
Espejo ( Acabado ceniza )



Exclusivo en compra de combo.

CÓDIGO	DESCRIPCIÓN	PRECIO
ABM01908	Ceniza	\$ 4,500.00

**Combo lavabo Glorena + kit de herrajes**

El combo incluye:  
Mueble: **Montanari** ceniza  
Ovalín Glorena: **ABOV1824**  
Espejo ( Acabado ceniza )  
Largo: 52 cm, Alto: 60 cm y Profundidad: 1.6 cm

**kit de herrajes:**  
Mezcladora: MEZL140C  
Dos llaves de retención: LLARAVCR  
Dos alimentadores: ALILV55  
Contra rejilla: CONLCZ  
Céspol: TRAL431  
Conector céspol: CONC114



CÓDIGO	DESCRIPCIÓN	PRECIO
ABM01893	Ceniza	\$ 5,600.00

**Combo lavabo Mantova**

El combo Mantova incluye:  
Mueble: **Montanari** nebraska  
Ovalín Mantova: **ABOV1821**  
Espejo ( Acabado nebraska )



Exclusivo en compra de combo.

CÓDIGO	DESCRIPCIÓN	PRECIO
ABM01909	Nebraska	\$ 4,500.00

**Combo lavabo Mantova + kit de herrajes**

El combo incluye:  
Mueble: **Montanari** nebraska  
Ovalín Mantova: **ABOV1821**  
Espejo ( Acabado nebraska )  
Largo: 52 cm, Alto: 60 cm y Profundidad: 1.6 cm

**kit de herrajes:**  
Mezcladora: MEZL139C  
Dos llaves de retención: LLARAVCR  
Dos alimentadores: ALILV55  
Contra rejilla: CONLCZ  
Céspol: TRAL431  
Conector céspol: CONC114



CÓDIGO	DESCRIPCIÓN	PRECIO
ABM01894	Nebraska	\$ 5,600.00

**Juego de accesorios para baño (4 piezas)**

Producto **NUEVO**



Producto sujeto a disponibilidad\*

CÓDIGO	DESCRIPCIÓN
ABAC1405	Negro mate

**Juego de accesorios para baño (4 piezas)**



Blister

CÓDIGO	DESCRIPCIÓN	PRECIO	INNER	MASTER
JAB017S	Metálico	\$ 323.00	1	40

**Juego de accesorios para baño (6 piezas)**



Caja Ventana

CÓDIGO	DESCRIPCIÓN	PRECIO	INNER	MASTER
JAB1133CD	Cromado/Dorado	\$ 463.00	1	10

**Juego de accesorios para baño (6 piezas)**



Caja Ventana

CÓDIGO	DESCRIPCIÓN	PRECIO	INNER	MASTER
JAB3100CD	Cromado/Dorado	\$ 680.00	1	10

**Juego de accesorios para baño (4 piezas)**



Blister

CÓDIGO	DESCRIPCIÓN	PRECIO	INNER	MASTER
JAB017PVC	PVC	\$ 171.00	1	50

**Juego de accesorios para baño (6 piezas)**



Caja Ventana

CÓDIGO	DESCRIPCIÓN	PRECIO	INNER	MASTER
JAB1132C	Cromado	\$ 390.00	1	10

**Juego de accesorios para baño (6 piezas)**



Caja Ventana

CÓDIGO	DESCRIPCIÓN	PRECIO	INNER	MASTER
JAB3100C	Cromado	\$ 560.00	1	10

**Juego de accesorios para baño (6 piezas)**



Caja Ventana

CÓDIGO	DESCRIPCIÓN	PRECIO	INNER	MASTER
JAB7600C	Cromado	\$ 735.00	1	10

El aspecto, empaque, inner o master de los productos puede variar sin previo aviso debido a la innovación continua de nuestras marcas.

**BAÑO**

**JUEGOS DE ACCESORIOS PARA BAÑO**

## Juego de accesorios para baño (5 piezas)



CÓDIGO	DESCRIPCIÓN	PRECIO	INNER	MASTER
JAB1500C	Cromado	\$ 850.00	1	10

## Juego de accesorios para baño (6 piezas)



CÓDIGO	DESCRIPCIÓN	PRECIO	INNER	MASTER
JAB6100CD	Cromado/Dorado	\$ 880.00	1	10

## Juego de accesorios para baño (6 piezas)



CÓDIGO	DESCRIPCIÓN	PRECIO	INNER	MASTER
JAB5020BN	Níquel pulido	\$ 1,140.00	1	10

## Juego de accesorios para baño (6 piezas)



CÓDIGO	DESCRIPCIÓN	PRECIO	INNER	MASTER
JAB8906C	Cromado	\$ 1,050.00	1	4

## Juego de accesorios para baño (6 piezas)



CÓDIGO	DESCRIPCIÓN	PRECIO	INNER	MASTER
JAB7206C	Cromado	\$ 840.00	1	10

## Juego de accesorios para baño (6 piezas)



CÓDIGO	DESCRIPCIÓN	PRECIO	INNER	MASTER
JAB5020C	Cromado	\$ 1,000.00	1	4

## Juego de accesorios para baño (6 piezas)



CÓDIGO	DESCRIPCIÓN	PRECIO	INNER	MASTER
JAB1300C	Cromado	\$ 1,100.00	1	10

## Juego de accesorios para baño (6 piezas)



CÓDIGO	DESCRIPCIÓN	PRECIO	INNER	MASTER
JAB8906BN	Níquel pulido	\$ 1,140.00	1	4

**Juego de accesorios para baño (6 piezas)**



CÓDIGO	DESCRIPCIÓN	PRECIO	INNER	MASTER
JAB2806C	Cromado	\$ 1,120.00	1	10

**Juego de accesorios para baño (6 piezas)**

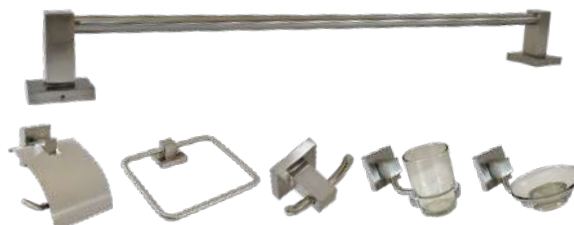

CÓDIGO	DESCRIPCIÓN	PRECIO	INNER	MASTER
JAB2806BN	Níquel pulido	\$ 1,340.00	1	10

**Juego de accesorios para baño (6 piezas)**



CÓDIGO	DESCRIPCIÓN	PRECIO	INNER	MASTER
JAB3900CS	Cromado/Satín	\$ 1,100.00	1	10

**Juego de accesorios para baño (6 piezas)**



CÓDIGO	DESCRIPCIÓN	PRECIO	INNER	MASTER
JAB6106C	Cromado	\$ 1,080.00	1	4

**Juego de accesorios para baño (6 piezas)**



CÓDIGO	DESCRIPCIÓN	PRECIO	INNER	MASTER
JAB6106CD	Cromado/Dorado	\$ 1,200.00	1	4

**Juego de accesorios para baño (6 piezas)**



CÓDIGO	DESCRIPCIÓN	PRECIO	INNER	MASTER
JAB6106BN	Níquel pulido	\$ 1,200.00	1	4

**Juego de accesorios para baño (6 piezas)**



CÓDIGO	DESCRIPCIÓN	PRECIO	INNER	MASTER
JAB6800BC	Blanco/Cromado	\$ 1,085.00	1	10

**Juego de accesorios para baño (6 piezas)**



CÓDIGO	DESCRIPCIÓN	PRECIO	INNER	MASTER
JAB6800BD	Blanco/Dorado	\$ 1,200.00	1	10

## Juego de accesorios para baño (6 piezas)



CÓDIGO	DESCRIPCIÓN	PRECIO	INNER	MASTER
JAB6800CD	Cromado/Dorado	\$ 1,200.00	1	10

## Juego de accesorios para baño (6 piezas)



CÓDIGO	DESCRIPCIÓN	PRECIO	INNER	MASTER
JAB2170BN	Níquel pulido	\$ 1,400.00	1	10

## Juego de accesorios para baño (6 piezas)



CÓDIGO	DESCRIPCIÓN	PRECIO	INNER	MASTER
JAB1520BN	Níquel pulido	\$ 1,810.00	1	4

## Organizador para regadera 46.5 x 25.5 x 9 cm

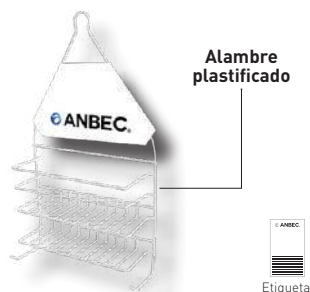

CÓDIGO	DESCRIPCIÓN	PRECIO	INNER	MASTER
ORB1694	Blanco	\$ 87.00	1	48

## Organizador para regadera 50 x 25 x 10 cm



CÓDIGO	DESCRIPCIÓN	PRECIO	INNER	MASTER
ORB1695	Blanco	\$ 146.00	1	12

## Organizador para regadera 46 x 26 x 12 cm



CÓDIGO	DESCRIPCIÓN	PRECIO	INNER	MASTER
ORB1696	Blanco	\$ 177.00	1	12

**Repisa esquinera para baño**

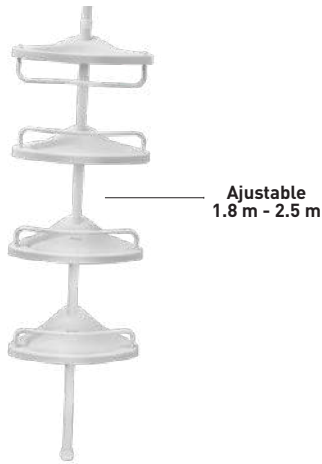

CÓDIGO	PRECIO	INNER	MASTER
REB4S	\$ 650.00	1	1

**Repisa para toallas  
62.9 x 21.8 x 14.2 cm**

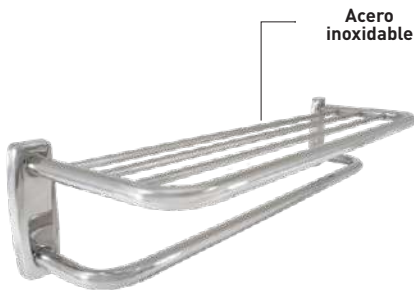

CÓDIGO	DESCRIPCIÓN	PRECIO	INNER	MASTER
RC502	Cromado	\$ 815.00	1	10

**Barra de seguridad 24"**



CÓDIGO	DESCRIPCIÓN	PRECIO	INNER	MASTER
BS24SS	Acero	\$ 440.00	1	24
BS24C	Cromado	\$ 420.00	1	24

**Tubo cortinero ajustable**

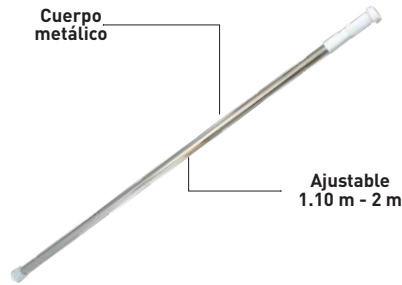

CÓDIGO	DESCRIPCIÓN	PRECIO	INNER	MASTER
TC1102C	Cromado	\$ 98.00	1	50

**Repisa para toallas  
63.6 x 23.8 x 17.5 cm**

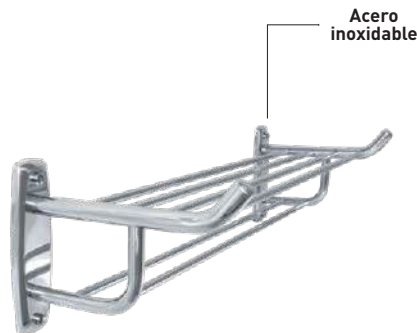

CÓDIGO	DESCRIPCIÓN	PRECIO	INNER	MASTER
RC501	Cromado	\$ 650.00	1	10

**Barra de seguridad 18"**

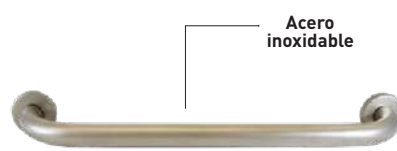

CÓDIGO	DESCRIPCIÓN	PRECIO	INNER	MASTER
B30118	Satín	\$ 490.00	1	50

**Repisa porta toallas  
63 x 21 x 17 cm**

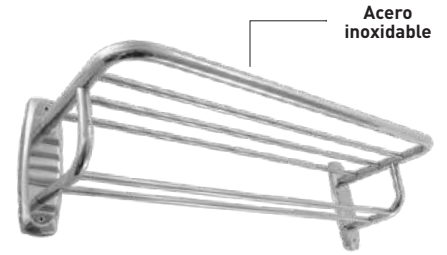

CÓDIGO	DESCRIPCIÓN	PRECIO	INNER	MASTER
R3306	Cromado	\$ 680.00	1	10

**Barra de seguridad con jabonera  
18"**



Acero inoxidable



CÓDIGO	DESCRIPCIÓN	PRECIO	INNER	MASTER
B30212	Cromado	\$ 560.00	1	10

**Barra de seguridad 18"**

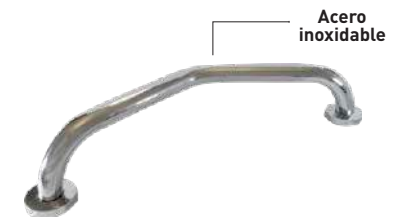

CÓDIGO	DESCRIPCIÓN	PRECIO	INNER	MASTER
B30312	Cromado	\$ 470.00	1	10

El aspecto, empaque, inner o master de los productos puede variar sin previo aviso debido a la innovación continua de nuestras marcas.

## Bridas para cortinero de baño

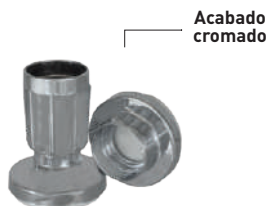

CÓDIGO	DESCRIPCIÓN	PRECIO	INNER	MASTER
BRIBPVC	ABS	\$ 46.00	1	200
BRIBM	Metálico	\$ 95.00	1	200

## Gancho triple Cuerpo de acero inoxidable

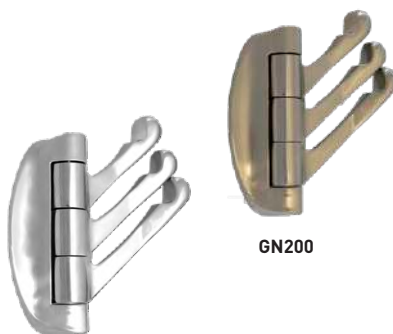

CÓDIGO	DESCRIPCIÓN	PRECIO	INNER	MASTER
GC100	Cromado	\$ 210.00	8	48
GN200	Níquel pulido	\$ 230.00	6	24

## Dosificador de jabón líquido manual

Producto NUEVO



Producto sujeto a disponibilidad\*

CÓDIGO	DESCRIPCIÓN
ANDS1401	Blanco

## Dosificador de jabón líquido manual

Producto NUEVO



Producto sujeto a disponibilidad\*

CÓDIGO	DESCRIPCIÓN
ANDS1402	Blanco

## Dosificador de jabón líquido manual

Producto NUEVO



Producto sujeto a disponibilidad\*

CÓDIGO	DESCRIPCIÓN
ANDS1403	Blanco

## Dosificador de jabón líquido automático

Producto NUEVO



Producto sujeto a disponibilidad\*

CÓDIGO	DESCRIPCIÓN
ANDS1404	Blanco

## Dosificador de jabón líquido manual



CÓDIGO	DESCRIPCIÓN	PRECIO	INNER	MASTER
J40801	Cromado	\$ 150.00	1	50

## Dosificador de jabón líquido manual



CÓDIGO	DESCRIPCIÓN	PRECIO	INNER	MASTER
J4122	Cromado	\$ 230.00	1	50

## Dosificador de jabón líquido manual



CÓDIGO	DESCRIPCIÓN	PRECIO	INNER	MASTER
J40201	Satin	\$ 430.00	1	50

El aspecto, empaque, inner o master de los productos puede variar sin previo aviso debido a la innovación continua de nuestras marcas.

**Espejo  
60 x 45 cm**



Vidrio biselado



Caja Etiqueta

CÓDIGO	PRECIO	INNER	MASTER
ESPM056	\$ 280.00	1	20

**Espejo  
60 x 80 cm**



Vidrio biselado



Caja Etiqueta

CÓDIGO	PRECIO	INNER	MASTER
ESPM057	\$ 460.00	1	10

**Espejo  
60 x 80 cm**



Vidrio biselado



Caja Etiqueta

CÓDIGO	PRECIO	INNER	MASTER
ESPM050	\$ 650.00	1	10

**Espejo  
60 x 80 cm**

Vidrio biselado



Caja Etiqueta

CÓDIGO	PRECIO	INNER	MASTER
ESPM030	\$ 965.00	1	10

**Espejo con repisas  
60 x 90 cm**

Vidrio biselado

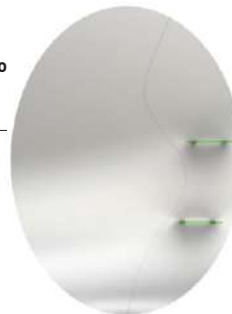

Repisas de vidrio



Caja Etiqueta

CÓDIGO	PRECIO	INNER	MASTER
ESPM046	\$ 870.00	1	10

**Espejo con repisas  
60 x 90 cm**

Vidrio biselado



Repisas de vidrio



Caja Etiqueta

CÓDIGO	PRECIO	INNER	MASTER
ESPM043	\$ 950.00	1	10

**Espejo con repisas  
70 x 90 cm**

Vidrio biselado



Caja Etiqueta

CÓDIGO	PRECIO	INNER	MASTER
ESPM045	\$ 1,260.00	1	10

**Espejo con repisas  
80 x 80 cm**

Vidrio biselado



Aro cromado



Caja Etiqueta

CÓDIGO	PRECIO	INNER	MASTER
ESPM004	\$ 1,450.00	1	10



Jabonera



CÓDIGO	PRECIO	INNER	MASTER
JM1006	\$ 110.00	1	60

Cepillero con vaso



CÓDIGO	PRECIO	INNER	MASTER
CV1005	\$ 100.00	1	60

Porta rollo semi-empotrable



CÓDIGO	PRECIO	INNER	MASTER
PS1004	\$ 94.00	1	100

Porta rollo

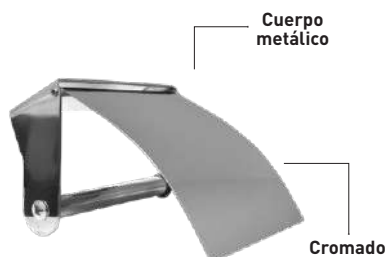

CÓDIGO	PRECIO	INNER	MASTER
PMC789	\$ 290.00	1	30

Porta rollo empotrable

Porta rollo empotrable

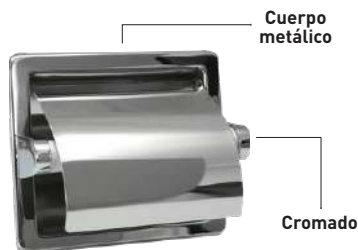

CÓDIGO	PRECIO	INNER	MASTER
PRE300	\$ 320.00	1	24

Toallero de barrel 24"

Porta rollo empotrable



CÓDIGO	PRECIO	INNER	MASTER
PB1001	\$ 11.00	1	400

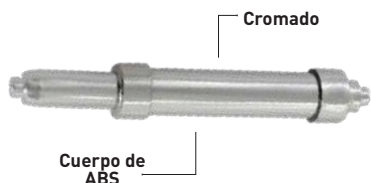

CÓDIGO	PRECIO	INNER	MASTER
PC1316	\$ 18.00	1	500



CÓDIGO	PRECIO	INNER	MASTER
BT1003	\$ 145.00	1	100

**Despachador de papel para sanitario**  
12.5 x 11.5 x 13 cm

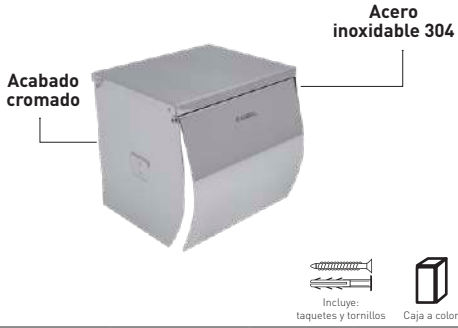

CÓDIGO	PRECIO	INNER	MASTER
ABDP1914	\$ 360.00	1	12

**Despachador de papel sanitario**  
27 x 12.5 cm



CÓDIGO	PRECIO	INNER	MASTER
ABDP1912	\$ 960.00	1	12

**Despachador de papel para manos**  
28 x 26 x 10 cm



CÓDIGO	PRECIO	INNER	MASTER
ABDP1913	\$ 1,200.00	1	12

**Despachador de papel para sanitario**  
19 x 12.8 x 16.8 cm



CÓDIGO	PRECIO	INNER	MASTER
DPB400	\$ 170.00	1	30

**Despachador de papel para sanitario**  
28.2 x 12 x 26.5 cm



CÓDIGO	PRECIO	INNER	MASTER
DPB401	\$ 380.00	1	12

**Despachador de papel para sanitario**  
19 x 12.8 x 16.8 cm



CÓDIGO	PRECIO	INNER	MASTER
DPWCN	\$ 170.00	1	30

**Despachador de papel para sanitario**  
28.2 x 12 x 26.5 cm

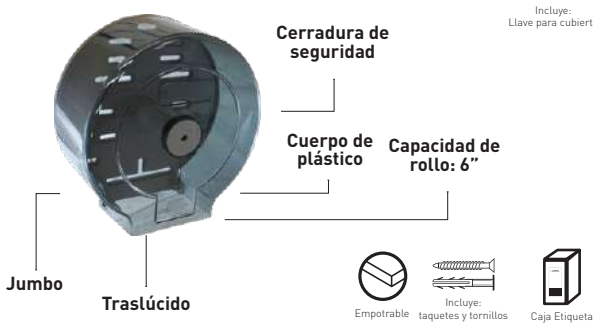

CÓDIGO	PRECIO	INNER	MASTER
DPWCJ	\$ 395.00	1	12

**Despachador de papel para sanitario**  
21.5 x 11.5 cm



CÓDIGO	PRECIO	INNER
DPW788A	\$ 1,000.00	1

**Despachador de papel en rollo para manos**  
195 - 200 mm



CÓDIGO	PRECIO	INNER	MASTER
DPRMJ	\$ 2,300.00	1	1

**Secador de manos eléctrico**  
28 x 22.5 x 38 cm



CÓDIGO	PRECIO	INNER	MASTER
SMBAA	\$ 5,800.00	1	4

## Sapito para sanitario plus 2"



CÓDIGO	PRECIO	INNER	MASTER
SP1018	\$ 16.00	1	200

## Sapito para sanitario plus 3"



CÓDIGO	PRECIO	INNER	MASTER
SP1028	\$ 28.00	1	400

## Sapito para sanitario con cadena



CÓDIGO	PRECIO	INNER	MASTER
SAPC	\$ 22.00	1	200

## Sapito para sanitario con rubber 2"



CÓDIGO	PRECIO	INNER	MASTER
SAPC705	\$ 38.00	3	72

## Sapito para sanitario con cadena rubber 2"



CÓDIGO	PRECIO	INNER	MASTER
SAPC763	\$ 44.00	3	72

## Sapito ajustable 3"



CÓDIGO	PRECIO	INNER	MASTER
SAPA1731	\$ 75.00	12	72

## Válvula de salida sanitario 2"

Largo: 8 1/2"



CÓDIGO	PRECIO	INNER	MASTER
VS1012	\$ 38.00	1	70

## Válvula de salida sanitario 2"

Largo: 8 1/2"



CÓDIGO	PRECIO	INNER	MASTER
VS617	\$ 53.00	1	50

## Juego de herrajes para sanitario completo



CÓDIGO	DESCRIPCIÓN	PRECIO	INNER	MASTER
JH1011	2"	\$ 70.00	1	30
JH1012	3"	\$ 118.00	1	30

**Válvula de entrada para sanitario**

**CARACTERÍSTICAS**

- Silenciosa
- Fuerte y durable
- Anti-sifón
- Fácil de girar y cerrar para reemplazarlo del sello
- Fácil ajuste del nivel del agua
- Mejora el desempeño del agua
- Incluye filtro
- Funciona desde la mínima presión de un tinaco hasta la máxima presión de un hidroneumático
- 94 L
- 65 Kg
- Ajuste de 11.43 cm a 26.67 cm



CÓDIGO	PRECIO	INNER	MASTER
VE620	\$ 120.00	1	24

**Válvula de entrada para sanitario**

**CARACTERÍSTICAS**

- Para alta o baja presión
- Válvula reguladora de precisión
- Filtro removible
- Se ajusta a cualquier tipo de tanque
- Anti-sifón



CÓDIGO	PRECIO	INNER	MASTER
VES1203	\$ 195.00	1	50

**Válvula de salida para sanitario descarga doble acción**



**CARACTERÍSTICAS**

- Incluye válvula, cable y botón
- Para sanitarios de dos piezas tradicionales
- Tubo con rebosadero con altura ajustable
- Para cualquier tipo de tanques
- Sistema de descarga para líquidos y sólidos



CÓDIGO	PRECIO	INNER	MASTER
VSS1204	\$ 320.00	1	25

**Válvula para sanitario profesional**

**CARACTERÍSTICAS**

- Se instala en minutos sin necesidad de herramienta
- Compatible con todos los WC
- Cuenta con un tornillo para ajustar nivel de agua, regulando la altura del cierre
- Sus componentes no se oxidan ni se corroen
- No contiene partes que puedan contaminar el agua
- Operación silenciosa
- Resiste químicos y limpiadores agresivos



CÓDIGO	PRECIO	INNER	MASTER
VWCP799	\$ 110.00	1	24

**Válvula de entrada sanitario**

**CARACTERÍSTICAS**

- Silenciosa
- Fuerte y durable
- Anti-sifón
- Fácil de girar y cerrar para reemplazarlo del sello
- Fácil ajuste del nivel del agua
- Incluye filtro
- Funciona desde la mínima presión de un tinaco hasta la máxima presión de un hidroneumático
- Válvula check
- Regulador de nivel tipo tornillo
- Ajuste de 23 cm a 35.5 cm



CÓDIGO	PRECIO	INNER	MASTER
VE987	\$ 230.00	1	50

## Empaque esponjoso para sanitario 2"



CÓDIGO	PRECIO	INNER	MASTER
EMPE	\$ 10.50	1	300

## Empaque esponjoso para sanitario 3"



CÓDIGO	PRECIO	INNER	MASTER
EE1025	\$ 35.00	1	60

## Flotador para sanitario 4"



Cuerpo de polietileno



CÓDIGO	PRECIO	INNER	MASTER
FP1015	\$ 6.00	1	100

## Conector universal



CÓDIGO	PRECIO	INNER	MASTER
ABCU1851	\$ 23.00	1	200

## Flotador poliuretano para tinaco / cisterna 6"



CÓDIGO	PRECIO	INNER	MASTER
FP1773	\$ 54.00	1	50

## Varilla para flotador sanitario 1/4" x 7"



CÓDIGO	PRECIO	INNER	MASTER
VF1014	\$ 4.50	25	500

## Manivela de descarga sanitario



Varilla metálica

Cuerpo de plástico



CÓDIGO	PRECIO	INNER	MASTER
MANSM	\$ 26.00	1	200

## Manivela para sanitario

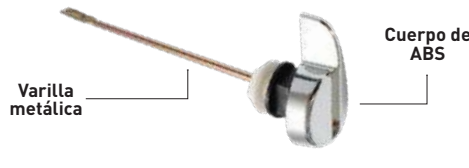

Varilla metálica

Cuerpo de ABS



CÓDIGO	PRECIO	INNER	MASTER
MANS670	\$ 29.00	1	200

## Manivela push lateral



Acabado cromado

Cuerpo de ABS



CÓDIGO	PRECIO	INNER	MASTER
MP1016	\$ 26.00	1	80

## Botón dual flush para sanitario



Cuerpo de ABS

Acabado cromado



CÓDIGO	DESCRIPCIÓN	PRECIO	INNER	MASTER
BDFS1808	1 - 1/2"	\$ 119.00	1	200
BDFS1809	2"	\$ 126.00	1	200

## Destapacaños 6"

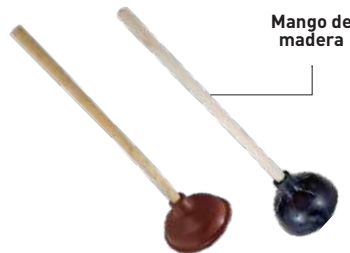

Mango de madera



CÓDIGO	DESCRIPCIÓN	PRECIO	INNER	MASTER
D1030R	Normal	\$ 45.00	1	24
D1318R	Reforzado	\$ 64.00	1	24

## Destapacaños



Largo de 50 cm

Tipo acordeón



CÓDIGO	PRECIO	INNER	MASTER
DTA1721	\$ 52.00	1	10

**Asiento corto de PVC con tapa 17"**

Incluye kit de instalación



CÓDIGO	DESCRIPCIÓN	PRECIO	INNER	MASTER
ASISC570	Blanco	\$ 150.00	1	10

**Asiento corto de madera con tapa 17"**

Incluye kit de instalación

Evita la presencia de hongo



CÓDIGO	DESCRIPCIÓN	PRECIO	INNER	MASTER
ASISMB	Blanco	\$ 267.00	1	6
ASISMH	Hueso	\$ 267.00	1	6
ASISMBE	Beige	\$ 267.00	1	6

**Asiento largo de plástico con tapa 19"**

Incluye kit de instalación



CÓDIGO	DESCRIPCIÓN	PRECIO	INNER	MASTER
ASISL569	Blanco	\$ 222.00	1	10
ASISL569H	Hueso	\$ 222.00	1	10

**Asiento largo de madera con tapa 19"**

Incluye kit de instalación



CÓDIGO	DESCRIPCIÓN	PRECIO	INNER	MASTER
ASISMLB	Blanco	\$ 360.00	1	6
ASISMLH	Hueso	\$ 360.00	1	6

**Asiento largo acojinado con tapa 19"**



CÓDIGO	DESCRIPCIÓN	PRECIO	INNER	MASTER
ASISLAB	Blanco	\$ 320.00	1	6

**Asiento largo cierre lento 19"**

Incluye kit de instalación



CÓDIGO	DESCRIPCIÓN	PRECIO	INNER	MASTER
ASISLA647	Blanco	\$ 550.00	1	6

**Asiento sanitario infantil**

Se adapta a todos los sanitarios, redondos y elongados

Ideal para el entrenamiento del bebé en el uso del baño



CÓDIGO	DESCRIPCIÓN	PRECIO	INNER	MASTER
ASIN1856	Rosa	\$ 200.00	1	4
ASIN1855	Azul	\$ 200.00	1	4

**Asiento corto acojinado tapa 17"**

Incluye kit de instalación

Evita la presencia de hongo



CÓDIGO	DESC.	PRECIO	INNER	MASTER
ASISAB	Blanco	\$ 230.00	1	12
ASISAN	Negro	\$ 230.00	1	12
ASISAH	Hueso	\$ 230.00	1	12
ASISAVJ	Verde jade	\$ 230.00	1	12
ASISAAC	Azul cielo	\$ 230.00	1	12
ASISAC	Coral	\$ 230.00	1	12
ASISAR	Rosa	\$ 230.00	1	12

## Cuello de cera individual

Sellador de fugas  
Evita malos olores  
fijación rápida y duradera



Cuerpo de cera



CÓDIGO	DESCRIPCIÓN	PRECIO	INNER	MASTER
CUECCG	Con guía	\$ 25.00	1	48

## Cuello de cera individual

Sellador de fugas  
Evita malos olores  
fijación rápida y duradera



Cuerpo de cera



CÓDIGO	DESCRIPCIÓN	PRECIO	INNER	MASTER
CUESG	Sin guía	\$ 20.00	1	100

## Cuello para sanitario rubber con guía

Con empaque protector  
Sellador de fugas  
Evita malos olores



Cuerpo de caucho



CÓDIGO	PRECIO	INNER	MASTER
CUES571	\$ 52.00	1	40

## Cuello corto para sanitario

Sellador de fugas  
Evita la salida de malos olores  
Sellado hermético  
Incluye kit de instalación



Cuerpo de PVC



CÓDIGO	PRECIO	INNER	MASTER
ABCC1848	\$ 130.00	1	40

## Cuello largo para sanitario 4"

Sellador de fugas  
Evita salida de malos olores  
Sellado hermético



Cuerpo de PVC



CÓDIGO	PRECIO	INNER	MASTER
ABCC1849	\$ 225.00	1	20

## Cuello para sanitario 4"

Sellador de fugas  
Evita salida de malos olores  
Sustituye al cuello de cera  
Incluye kit de instalación



Cuerpo de PVC



CÓDIGO	PRECIO	INNER	MASTER
BS1025	\$ 60.00	1	40

## Cuello flexible para sanitario 4"

Sellador de fugas  
Evita los malos olores  
Sella herméticamente



Cuerpo de PVC flexible



CÓDIGO	PRECIO	INNER	MASTER
BFS1353	\$ 50.00	1	60

## Cuello adaptador para desagüe

Sellador de fugas  
Evita los malos olores  
Sella herméticamente



Anillo metálico

Cuerpo de PVC



CÓDIGO	PRECIO	INNER	MASTER
BEX646	\$ 175.00	1	32

## Cuello para sanitario

Sellador de fugas  
Sella herméticamente



Cuerpo de PVC



CÓDIGO	PRECIO	INNER	MASTER
ABCS1850	\$ 66.00	1	50

## Pijas para sanitario latón 3 1/2" (juego)



CÓDIGO	PRECIO	INNER	MASTER
PIJS	\$ 15.30	25	400

## Tornillo de sujeción taza/tanque metálico (juego)



CÓDIGO	PRECIO	INNER	MASTER
TORST	\$ 18.00	30	200

## Tornillo ancla para brida sanitario 2 1/4"

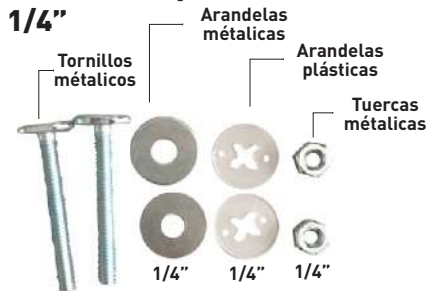

CÓDIGO	PRECIO	INNER	MASTER
ABTB1967	\$ 22.00	25	500

**Rejilla para coladera 3 1/2"**

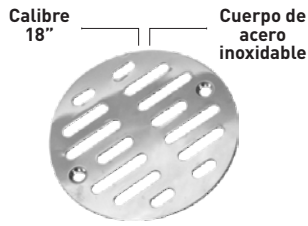

CÓDIGO	PRECIO	INNER	MASTER
RAI451	\$ 14.00	1	500

**Rejilla para coladera 4 3/4"**

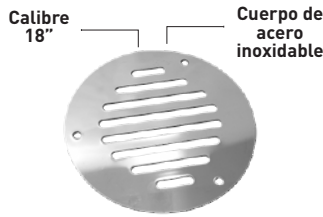

CÓDIGO	PRECIO	INNER	MASTER
REJC4	\$ 28.00	1	200

**Rejilla para coladera 4"**

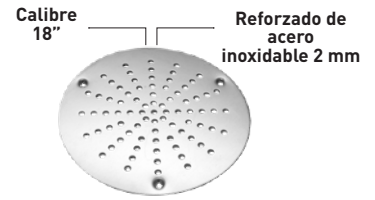

CÓDIGO	PRECIO	INNER	MASTER
RCA1194	\$ 42.00	1	200

**Coladera 2"**

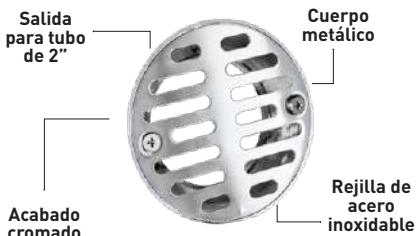

CÓDIGO	PRECIO	INNER	MASTER
COLM	\$ 38.00	1	200

**Rejilla para coladera 4"**

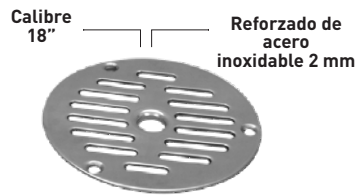

CÓDIGO	PRECIO	INNER	MASTER
REJA14	\$ 67.00	1	100

**Coladera universal para conexión codo 2", 3" y 4"**



CÓDIGO	PRECIO	INNER	MASTER
CU1020	\$ 32.00	1	100

**Coladera universal para tubo 1/2", 1", 2", 3" y 4"**

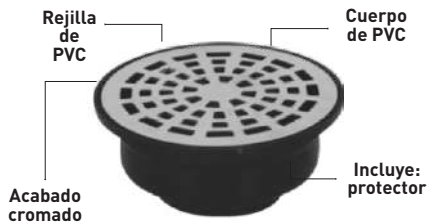

CÓDIGO	PRECIO	INNER	MASTER
CU1017	\$ 32.00	1	100

**Coladera universal**



CÓDIGO	DESCRIPCIÓN	PRECIO	INNER	MASTER
COLU467	Cromado	\$ 58.00	1	50

**Coladera universal**



CÓDIGO	DESCRIPCIÓN	PRECIO	INNER	MASTER
CU619L	Cromado	\$ 77.00	1	50

**Coladera universal Para tubería de 2", 3", y 4" Evita el paso de insectos Cuerpo de PVC**



CÓDIGO	DESCRIPCIÓN	PRECIO	INNER	MASTER
ANCU2002	Blanco	\$ 32.00	1	100
ANCU2001	Cromado	\$ 47.00	1	100

**Coladera universal**



CÓDIGO	PRECIO	INNER	MASTER
CU618	\$ 70.00	1	50



## Coladera larga 30 x 5 cm

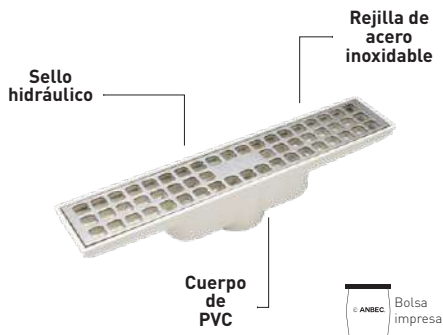

CÓDIGO	PRECIO	INNER	MASTER
CLA722	\$ 76.00	1	40

## Resumidero largo 60 cm

Producto NUEVO



Producto sujeto a disponibilidad\*

CÓDIGO	DESCRIPCIÓN
ABRR1406	Acero inoxidable

## Resumidero largo 60 cm

Producto NUEVO



Producto sujeto a disponibilidad\*

CÓDIGO	DESCRIPCIÓN
ABRR1407	Acero inoxidable

## Resumidero cuadrado

Producto NUEVO



Producto sujeto a disponibilidad\*

CÓDIGO	DESCRIPCIÓN
ABRC1408	Acero inoxidable

## Resumidero triangular

Producto NUEVO



Producto sujeto a disponibilidad\*

CÓDIGO	DESCRIPCIÓN
ABRT1409	Acero inoxidable

## Resumidero triangular

Producto NUEVO



Producto sujeto a disponibilidad\*

CÓDIGO	DESCRIPCIÓN
ABRT1410	Acero inoxidable

## Resumidero 4"

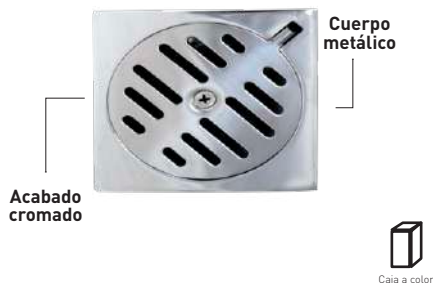

CÓDIGO	PRECIO	INNER	MASTER
R5004Z4	\$ 100.00	1	50

## Resumidero 4"

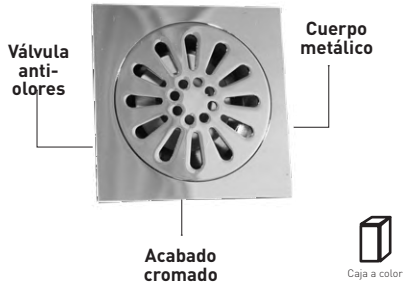

CÓDIGO	PRECIO	INNER	MASTER
RVA1786C	\$ 137.00	1	50

## Resumidero 4"

Cuerpo de latón

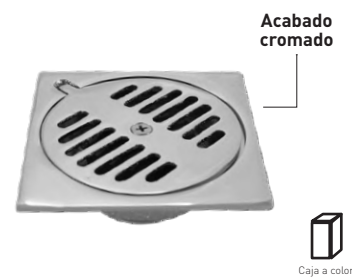

CÓDIGO	PRECIO	INNER	MASTER
R2034L4	\$ 300.00	1	50

## Resumidero 6"

Cuerpo de latón



CÓDIGO	DESCRIPCIÓN	PRECIO	INNER	MASTER
R2034L6	Cromado	\$ 600.00	1	50

## Resumidero 6"

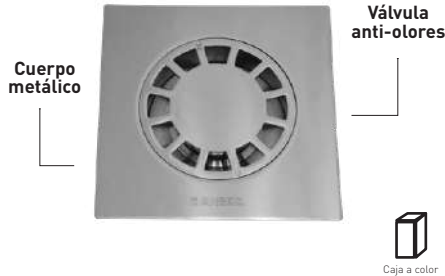

CÓDIGO	PRECIO	INNER	MASTER
RVA1787C	\$ 250.00	1	40

## Resumidero cuadrado 10"

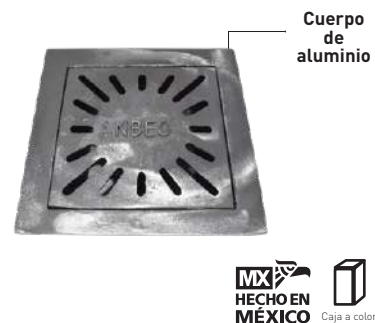

CÓDIGO	PRECIO	INNER	MASTER
RCA983	\$ 415.00	1	10

**Soporte para lavabo (juego)**



Cuerpo metálico



CÓDIGO	PRECIO	INNER	MASTER
SOPLM	\$ 12.00	25	200

**Soporte para lavabo reforzado**

Mas resistencia al peso por su fabricación de acero galvanizado de una sola pieza



Incluye: 1 soporte, 4 taquetes y 4 tornillos

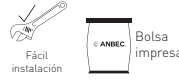

CÓDIGO	PRECIO	INNER	MASTER
SLR1195	\$ 55.00	1	100

**Cinta selladora para sanitario (rubber) 1.8**



CÓDIGO	PRECIO	INNER	MASTER
CSS1223	\$ 42.00	1	120

**Tapón para lavabo 38 x 35 mm**



CÓDIGO	DESCRIPCIÓN	PRECIO	INN.	MAS.
ABTL1901	Anillo metálico	\$ 9.00	20	1000
ABTL1903	Anillo acero inox.	\$ 10.00	1	15

**Tapón para lavabo 36 x 24 mm**



CÓDIGO	DESCRIPCIÓN	PRECIO	INN.	MAS.
ABTL1902	Cadena de 260 mm	\$ 27.00	15	300

**Contra para lavabo 1 1/4"**



Rejilla blanca

Con rebosadero

Cuerpo de PVC



CÓDIGO	PRECIO	INNER	MASTER
CONLSB	\$ 21.00	1	100

**Contra para lavabo 1 1/4"**



Superficie de metal cromada

Cuerpo de PVC

Rejilla blanca

Con rebosadero

Incluye: tapón cadena



CÓDIGO	PRECIO	INNER	MASTER
CONLSC	\$ 30.00	1	100

**Contra para lavabo 1 1/4"**

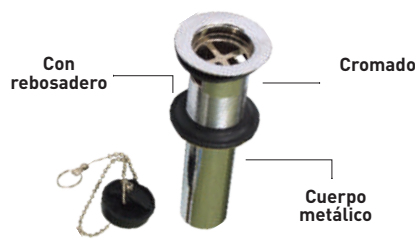

Cromado

Con rebosadero

Cuerpo metálico



Incluye: tapón cadena



CÓDIGO	PRECIO	INNER	MASTER
CONL669	\$ 100.00	1	50

**Contra para lavabo con tapón push 1 1/4"**



Cuerpo metálico

Con rebosadero

CONLCZ1889



CONLCZ

CÓDIGO	DESCRIPCIÓN	PRECIO	INNER	MAS.
CONLCZ	Cromado	\$ 230.00	1	50
CONLCZ1889	Níquel pulido	\$ 270.00	1	50

**Contra para lavabo cuadrada con tapón push 1 1/4"**

Cuerpo de latón



Con rebosadero

CON1858

CON1862



CÓDIGO	DESCRIPCIÓN	PRECIO	INNER	MASTER
CON1858	Cromado	\$ 250.00	1	100
CON1862	Níquel pulido	\$ 320.00	1	100

**Contra para lavabo 1 1/4"**



Sistema automático pop-up

Cuerpo de PVC

Incluye: varillas



CÓDIGO	DESCRIPCIÓN	PRECIO	INNER	MASTER
DESAPC	Cromado	\$ 62.00	1	50

**Contra para lavabo 1 1/4"**

Cuerpo de latón

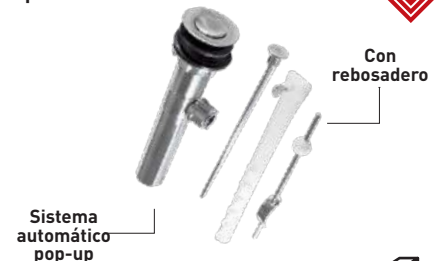

Sistema automático pop-up

Con rebosadero



CÓDIGO	PRECIO	INNER	MASTER
DESABCC	\$ 260.00	1	50

## Césped para lavabo / fregadero



CÓDIGO	PRECIO	INNER	MASTER
TLF1099	\$ 36.00	1	50

## Césped para lavabo 1 1/4"

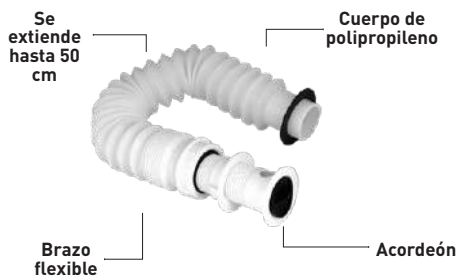

CÓDIGO	PRECIO	INNER	MASTER
TL1024	\$ 47.00	1	100

## Césped para lavabo 1 1/4"

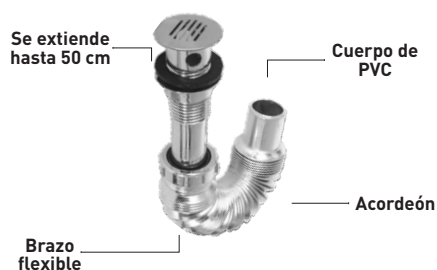

CÓDIGO	PRECIO	INNER	MASTER
TL761C	\$ 84.00	1	100

## Césped flexible para lavabo 1 1/4"



CÓDIGO	PRECIO	INNER	MASTER
TRA1662	\$ 55.00	1	50

## Césped para lavabo



CÓDIGO	PRECIO	INNER	MASTER
TL1085	\$ 52.00	1	50

## Césped para lavabo 1 1/4"



Incluye: chapetón metálico



CÓDIGO	DESCRIPCIÓN	PRECIO	INNER	MASTER
TRAL431	Cromado	\$ 155.00	1	50

## Césped para lavabo 1 1/4"



CÓDIGO	PRECIO	INNER	MASTER
TLF1095	\$ 42.00	1	50

## Césped para lavabo 1 1/4"

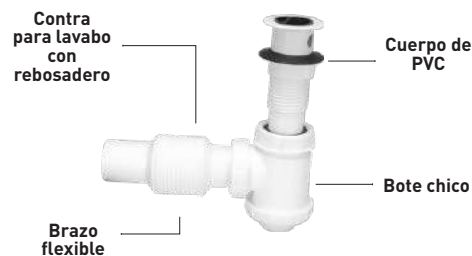

CÓDIGO	PRECIO	INNER	MASTER
TRAL466	\$ 68.00	1	50

## Césped para lavabo 1 1/4"

Incluye: chapetón y contra para lavabo



CÓDIGO	DESCRIPCIÓN	PRECIO	INNER	MASTER
TRALCM	Cromado	\$ 225.00	1	50

**Céspol para lavabo 1 1/4"**

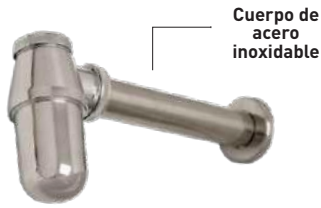

Cuerpo de acero inoxidable

Incluye: chapetón



Caja a color

CÓDIGO	DESCRIPCIÓN	PRECIO	INNER	MASTER
TRAL1317	Cromado	\$ 215.00	1	50

**Conector céspol**



Bolsa impresa

CÓDIGO	DESCRIPCIÓN	PRECIO	INNER	MASTER
CONC112	Fregador 2x1 1/2"	\$ 5.80	50	300
CONC114	Lavabo 2x1 1/4"	\$ 5.80	50	300

**Abrazadera para ducto de aluminio 4"**

Cuerpo metálico  
Bolsa con 2 piezas

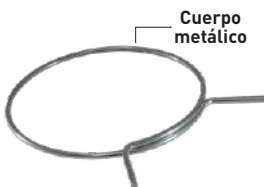

Cuerpo metálico



Bolsa Etiqueta

CÓDIGO	PRECIO	INNER	MASTER
ANAM1931	\$ 25.00	1	1000

**Céspol para lavabo 1 1/4"**



Cuerpo de acero inoxidable

Contra para lavabo



Caja a color

CÓDIGO	PRECIO	INNER	MASTER
TRAL1663	\$ 280.00	1	20

**Extensión lavabo 1 1/4"**



Cuerpo de PVC



Bolsa Etiqueta

CÓDIGO	DESC.	PRECIO	INN.	MAS.
EXTLPVC	20 cm	\$ 14.00	25	250

**Extensión para lavabo/fregadero flexible**

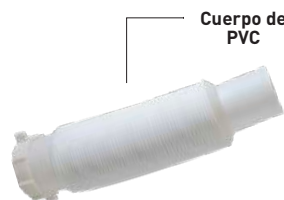

Cuerpo de PVC



Bolsa impresa

CÓDIGO	DESC.	PRECIO	INN.	MAS.
ELF1023	11.5-25 cm	\$ 22.00	1	100
ELF1022	15-50 cm	\$ 32.00	1	100
ELF1021	23-75 cm	\$ 42.00	1	50

**Céspol para lavabo 1 1/4"**

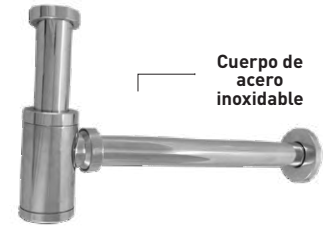

Cuerpo de acero inoxidable



Caja a color

CÓDIGO	PRECIO	INNER	MASTER
TRAL1653	\$ 480.00	1	20

**Extensión lavabo 1 1/4"**



Acero inoxidable



Bolsa Etiqueta

CÓDIGO	DESC.	PRECIO	INN.	MAS.
EXTLM	15 cm	\$ 38.00	1	100
EXTLM30	30 cm	\$ 70.00	1	100

**Extensión para lavabo/fregadero flexible de 23 a 75 cm**

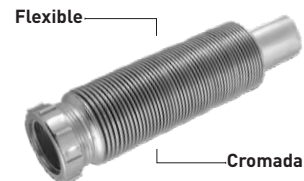

Flexible

Cromada



Bolsa impresa

CÓDIGO	PRECIO	INNER	MASTER
ELF762C	\$ 63.00	1	50

## Extensión para lavabo 1/4"



CÓDIGO	PRECIO	INNER	MASTER
ABEF1853	\$ 110.00	1	40

## Caja de salida para lavadora

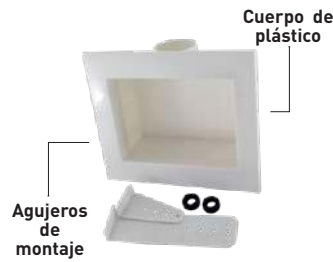

CÓDIGO	PRECIO	INNER	MASTER
CEL450	\$ 160.00	1	8

## Caja empotrable para refrigerador



CÓDIGO	PRECIO	INNER	MASTER
CER1807	\$ 114.00	1	30

## Ducto para filtro atrapa pelusa 4" x 1.50 m



CÓDIGO	PRECIO	INNER	MASTER
DFAT674	\$ 76.00	1	50

## Ducto para filtro atrapa pelusa 2.40 m



CÓDIGO	DESC.	PRECIO	INN.	MAS.
DFAT1773	3"	\$ 126.00	1	30
DFAT1720	4"	\$ 158.00	1	30
DFAT1774	5"	\$ 190.00	1	15
DFAT1775	6"	\$ 222.00	1	12

## Ducto de aluminio para filtro atrapa pelusas 50 cm x 10 cm

Resistente a la corrosión

Resistente a altas temperaturas



CÓDIGO	PRECIO	INN.	MAS.
DAR675	\$ 111.00	1	20

## Filtro atrapa pelusa con ducto

Para secadoras  
Resistente a altas temperaturas  
130 cm de largo  
Incluye 2 cinchos de plástico  
Para uso interno



CÓDIGO	PRECIO	INNER	MASTER
FAT673	\$ 260.00	1	20

## Filtro atrapa pelusa con ducto

Para secadoras  
Resistente a altas temperaturas  
240 cm de largo  
Incluye 2 cinchos de plástico  
Para uso interno



CÓDIGO	PRECIO	INNER	MASTER
FAT1722	\$ 200.00	1	30

**Maneral para llave jardín**



CÓDIGO	PRECIO	INNER	MASTER
MLLJ	\$ 13.00	100	500

**Llave compacta para jardín de 1/2"**  
Cuerpo de latón



CÓDIGO	PRECIO	INNER	MASTER
LLAC1423	\$ 49.00	12	120

**Llave de jardín 1/2"**  
Cuerpo de latón



CÓDIGO	DESCRIPCIÓN	PRECIO	INNER	MASTER
LLAJ12	1/2" peso 137 g	\$ 59.00	12	120
LLAJ34	3/4" peso 150 g	\$ 83.00	12	120

**Llave de jardín 1/2"**  
Cuerpo de latón



CÓDIGO	DESCRIPCIÓN	PRECIO	INNER	MASTER
LLAJ12C	Peso 163 g	\$ 90.00	12	80

**Llave de jardín 1/2"**  
Cuerpo de latón

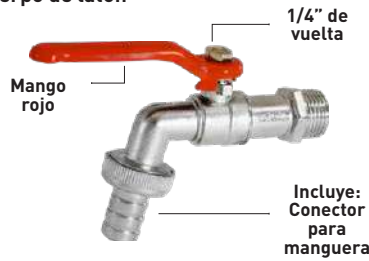

CÓDIGO	DESCRIPCIÓN	PRECIO	INNER	MASTER
LLAJEH12	Peso 156 g	\$ 80.00	12	120

**Llave de jardín esfera 1/2"**  
Cuerpo de latón



CÓDIGO	DESCRIPCIÓN	PRECIO	INNER	MASTER
LLAJEMA12	Peso 188 g	\$ 115.00	10	100

**Llave de jardín 1/2"**  
Cuerpo de latón



CÓDIGO	DESCRIPCIÓN	PRECIO	INNER	MASTER
LLAJ12CL	Peso 160 g	\$ 95.00	10	100

**Llave de jardín 1/2"**  
Cuerpo de latón



CÓDIGO	DESCRIPCIÓN	PRECIO	INNER	MASTER
LLAJ12CR	Peso 145 g	\$ 95.00	10	100

**Llave de jardín 1/2"**

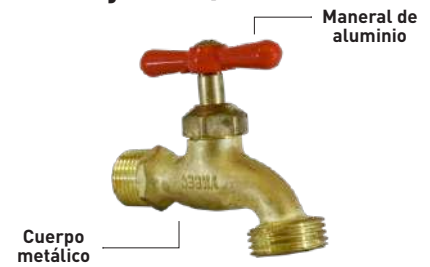

CÓDIGO	DESCRIPCIÓN	PRECIO	INNER	MASTER
LLAJ100	Peso 130 g	\$ 42.00	10	100

**Llave de jardín 1/2"**



CÓDIGO	DESCRIPCIÓN	PRECIO	INNER	MASTER
LLAJ103	Peso 133 g	\$ 46.00	12	120

**Llave de seguridad para exterior para poner candado 1/2"**

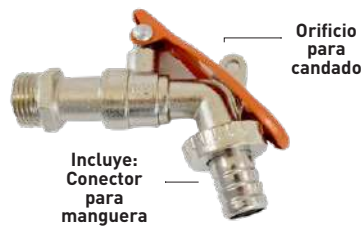

CÓDIGO	DESCRIPCIÓN	PRECIO	INNER	MASTER
LLAJ106	Peso 100 g	\$ 42.00	10	100

**Llave de jardín 1/2"**  
Cuerpo de latón



CÓDIGO	DESCRIPCIÓN	PRECIO	INNER	MASTER
LLAJ105	Peso 130 g	\$ 70.00	10	100

El aspecto, empaque, inner o master de los productos puede variar sin previo aviso debido a la innovación continua de nuestras marcas.

## Llave de jardín 1/2"



CÓDIGO	DESCRIPCIÓN	PRECIO	INNER	MASTER
LLAJ101	Peso 137 g	\$ 70.00	10	100

## Llave de jardín nariz lisa 1/2"



CÓDIGO	DESCRIPCIÓN	PRECIO	INNER	MASTER
LLAJ102	Peso 130 g	\$ 70.00	10	100

## Llave para fregador con niple y chapetón 1/2"

Cuerpo de latón

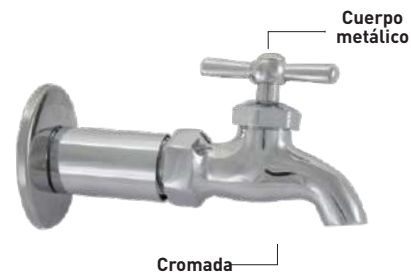

CÓDIGO	PRECIO	INNER	MASTER
LLAJ104	\$ 140.00	8	80

## Llave individual para fregador con chapetón

Cuerpo de latón

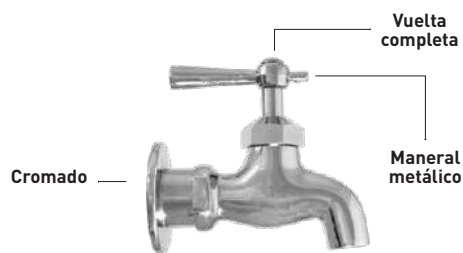

CÓDIGO	DESCRIPCIÓN	PRECIO	INNER	MASTER
LLAIFCH	Peso 230 g	\$ 232.00	10	100

## Llave de jardín 1/2"

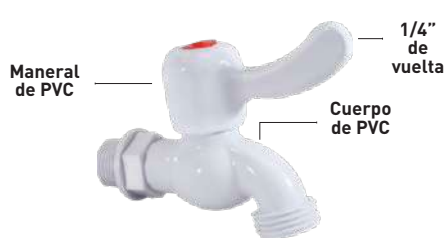

CÓDIGO	DESCRIPCIÓN	PRECIO	INNER	MASTER
LLAJ12PVC	1/2"	\$ 33.00	20	200
LLAJ34PVC	3/4"	\$ 36.00	20	200

## Llave individual para lavabo

Cuerpo de latón



CÓDIGO	DESCRIPCIÓN	PRECIO	INNER	MASTER
LLAILM	Peso 230 g	\$ 122.00	1	24

## Llave individual para lavabo

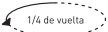

CÓDIGO	DESCRIPCIÓN	PRECIO	INNER	MASTER
LLAILA	Peso 200 g	\$ 150.00	1	60



**Llave de retención angular 1/2" x 1/2"**

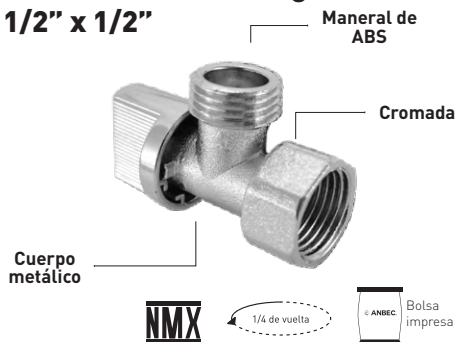

CÓDIGO	DESCRIPCIÓN	PRECIO	INNER	MASTER
LLARAZ	Peso 62 g	\$ 34.00	32	320

**Llave de retención angular 1/2" x 1/2"**  
Cuerpo de latón



CÓDIGO	PRECIO	INNER	MASTER
LLAR1673	\$ 60.00	10	100

**Llave de retención angular 1/2" x 3/8"**  
Cuerpo de latón



CÓDIGO	DESCRIPCIÓN	PRECIO	INNER	MASTER
LLAR1672	Peso 110 g	\$ 85.00	10	100

**Llave de retención angular 1/2" x 1/2"**  
Cuerpo de latón



CÓDIGO	DESCRIPCIÓN	PRECIO	INNER	MASTER
LLAR1671	Peso 130 g	\$ 90.00	10	100

**Llave de retención 1/2" x 1/2"**



CÓDIGO	DESCRIPCIÓN	PRECIO	INNER	MASTER
LLARAVC	Peso 72 g	\$ 40.00	32	320

**Llave de retención recta 1/2"**  
Cuerpo de latón



CÓDIGO	DESCRIPCIÓN	PRECIO	INNER	MASTER
LLARRE	Peso 100 g	\$ 66.00	20	200

**Llave de retención ángulo esfera 1/2" x 1/2"**  
Cuerpo de latón

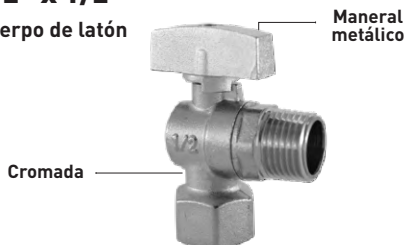

CÓDIGO	DESCRIPCIÓN	PRECIO	INNER	MASTER
LLARAER	Peso 135 g	\$ 90.00	24	240

**Llave de retención angular 1/2" x 1/2"**  
Cuerpo de latón



CÓDIGO	PRECIO	INNER	MASTER
LLAR1674	\$ 100.00	10	100

**LLAVES DE RETENCIÓN**

**Llave de retención 1/2" x 1/2"**



CÓDIGO	DESCRIPCIÓN	PRECIO	INNER	MASTER
LLARAVCR	Peso 89 g	\$ 46.00	18	180

**Llave de retención ángulo 1/2" x 1/2"**  
Cuerpo de latón



CÓDIGO	DESCRIPCIÓN	PRECIO	INNER	MASTER
LLARALG	Peso 110 g	\$ 70.00	10	100

**Llave de retención recta 1/2" x 3/8"**  
Cuerpo de latón



CÓDIGO	DESCRIPCIÓN	PRECIO	INNER	MASTER
LLAR1670	Peso 128 g	\$ 90.00	10	100

**Llave de retención angular 1/2" x 1/4"**  
Cuerpo de latón



CÓDIGO	PRECIO	INNER	MASTER
ANVR1932	\$ 200.00	10	100

**Producto NUEVO**



## Fluxómetro de botón para mingitorio

Cuerpo de latón

2 a 3 litros por descarga



CÓDIGO	DESCRIPCIÓN	PRECIO	INNER	MASTER
LLATM	Cromado	\$ 560.00	1	40

## Fluxómetro temporizador para mingitorio con botón

Tiempo de retardo: 4-8 segundos

Rango de flujo: 2-3 L por descarga



CÓDIGO	DESCRIPCIÓN	PRECIO	INNER	MASTER
FTM1471	Cromado	\$ 960.00	1	40

## Fluxómetro de manija para mingitorio 3/4"

2 a 3 l por descarga

Producto NUEVO



CÓDIGO	DESC.	PRECIO	INNER	MASTER
ABFM1916	Cromado	\$ 2,400.00	1	6

## Fluxómetro temporizador para sanitario con palanca

Tiempo de retardo: 4-8 segundos

Rango de flujo: 5 a 6 L por descarga



CÓDIGO	DESC.	PRECIO	INNER	MASTER
FTM1472	Cromado	\$ 2,800.00	1	10

## Fluxómetro con sensor para mingitorio

2 a 3 litros por descarga



CÓDIGO	DESCRIPCIÓN	PRECIO	INN.	MAS.
ABFM1915	Cromado	\$ 2,400.00	1	6

## Fluxómetro con sensor para sanitario

5.5 a 6 litros por descarga manual



CÓDIGO	DESCRIPCIÓN	PRECIO	INNER	MASTER
ABFS1911	Cromado	\$ 5,000.00	1	6

## Llave para bebedero de botón



CÓDIGO	DESCRIPCIÓN	PRECIO	INNER	MASTER
LLAB105	Peso 510 g	\$ 560.00	1	30

## Llave para mingitorio con resorte

Cuerpo de latón



CÓDIGO	DESCRIPCIÓN	PRECIO	INNER	MASTER
LLAM	Peso 550 g	\$ 525.00	1	45

## Llave para bebedero con resorte



CÓDIGO	DESCRIPCIÓN	PRECIO	INNER	MASTER
LLAB	Peso 745 g	\$ 720.00	1	40

**Llave para lavadora 3/4" x 1/2"**

Cuerpo de latón

Peso:  
176 g



CÓDIGO	DESCRIPCIÓN	PRECIO	INNER	MASTER
LLALMR	Mango rojo	\$ 92.00	12	120
LLALMA	Mango azul	\$ 92.00	12	120

**Válvula esfera roscable 1/2"**

Para agua,  
aceite y gas



Mango azul



CÓDIGO	DESCRIPCIÓN	PRECIO	INNER	MASTER
LLAER12MA	Peso 138 g	\$ 65.00	10	100

**Válvula esfera soldable 1/2"**

Para agua,  
aceite y gas



Mango rojo



CÓDIGO	PRECIO	INNER	MASTER
LLAES12MA	\$ 62.00	10	100

**Válvula esfera roscable**

Para agua,  
aceite y gas



LLAER34

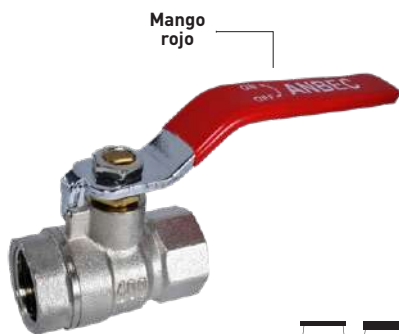

Mango rojo

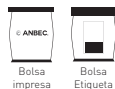

CÓDIGO	DESCRIPCIÓN	PRECIO	INN.	MAS.
LLAER14	1/4"	\$ 60.00	10	100
LLAER38	3/8"	\$ 76.00	10	100
LLAER12	1/2" 175 g	\$ 86.00	10	100
LLAER34	3/4" 235 g	\$ 115.00	10	100
LLAER1	1" 350 g	\$ 174.00	6	60
LLAER114	1 1/4" 495 g	\$ 250.00	6	36
LLAER112	1 1/2" 720 g	\$ 430.00	4	24
LLAER2	2" 1050 g	\$ 660.00	2	16
LLAER3	3" 3900 g	\$ 2,200.00	1	6
LLAER4	4" 6100 g	\$ 3,300.00	1	4

**Válvula esfera soldable**

Para agua,  
aceite y gas



Mango rojo



CÓDIGO	DESCRIPCIÓN	PRECIO	INNER	MASTER
LLAES34	3/4" 250 g	\$ 113.00	10	100
LLAES1	1" 250 g	\$ 175.00	1	50

**Válvula de compuerta de 1/2"**

Cuerpo de latón

Peso: 180 g

Para agua,  
aceite y gas



Maneral metálico



CÓDIGO	DESCRIPCIÓN	PRECIO	INNER	MASTER
LLACR12	Roscable	\$ 74.00	12	120
LLACS12	Soldable	\$ 74.00	12	120

**Válvula de compuerta de 3/4"**

Cuerpo de latón

Peso: 240 g

Para agua,  
aceite y gas



Maneral metálico



CÓDIGO	DESCRIPCIÓN	PRECIO	INNER	MASTER
LLACR34	Roscable	\$ 104.00	10	120
LLACS34	Soldable	\$ 104.00	10	120

**Válvula de paso roscable**

Cuerpo de latón



Maneral metálico



CÓDIGO	DESCRIPCIÓN	PRECIO	INNER	MASTER
LLAPBR12	1/2" 180 g	\$ 86.00	12	100
LLAPBR34	3/4" 267 g	\$ 130.00	8	80

**Válvula de paso soldable**

Cuerpo de latón



Maneral metálico



CÓDIGO	DESCRIPCIÓN	PRECIO	INNER	MASTER
LLAPBS12	1/2" 180 g	\$ 86.00	12	120
LLAPBS34	3/4" 267 g	\$ 130.00	8	72

**Válvula de banqueta**

Cuerpo de latón



CÓDIGO	DESCRIPCIÓN	PRECIO	INNER	MASTER
VB12B	1/2" 250 g	\$ 165.00	10	100
VB34B	3/4" 250 g	\$ 225.00	10	100

**Válvula de seguridad para boiler**

Cuerpo de latón



Roscable



CÓDIGO	DESCRIPCIÓN	PRECIO	INNER	MASTER
VSB12	1/2" 128 g	\$ 105.00	12	120
VSB34	3/4" 223 g	\$ 195.00	10	100

El aspecto, empaque, inner o master de los productos puede variar sin previo aviso debido a la innovación continua de nuestras marcas.

## Válvula compacta para tanque alto

Cuerpo de latón

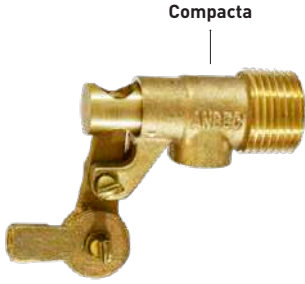

CÓDIGO	DESCRIPCIÓN	PRECIO	INNER	MASTER
VTA703	1/2"	\$ 65.00	10	100
VTA704	3/4"	\$ 90.00	10	100

## Válvula para tanque alto

Cuerpo de latón



CÓDIGO	DESCRIPCIÓN	PRECIO	INNER	MASTER
VTA12B	1/2" 175 g	\$ 116.00	10	100
VTA34B	3/4" 260 g	\$ 168.00	10	100

## Válvula check vertical corta

Cuerpo de latón  
Roscable



CÓDIGO	DESCRIPCIÓN	PRECIO	INNER	MASTER
VCHVC12	1/2" 115 g	\$ 68.00	10	100
VCHVC34	3/4" 175 g	\$ 98.00	10	100

## Válvula check vertical larga

Cuerpo de latón  
Roscable



CÓDIGO	DESCRIPCIÓN	PRECIO	INNER	MASTER
VCHVL12	1/2" 177 g	\$ 116.00	10	100
VCHVL34	3/4" 240 g	\$ 135.00	10	80

## Pichancha

Cuerpo de latón



CÓDIGO	DESCRIPCIÓN	PRECIO	INNER	MASTER
PICH34B	3/4" 180 g	\$ 90.00	10	100
PICH1B	1" 217 g	\$ 105.00	10	100
PICH114B	1 1/4" 335 g	\$ 190.00	1	80
PICH112B	1 1/2" 422 g	\$ 250.00	1	60
PICH2B	2" 630 g	\$ 420.00	1	30

## Pichancha vertical



CÓDIGO	DESCRIPCIÓN	PRECIO	INNER	MASTER
PICHAC12	1/2"	\$ 70.00	10	100
PICHAC34	3/4"	\$ 105.00	10	100
PICHAC1	1"	\$ 115.00	6	60
PICHAC114	1 1/4"	\$ 230.00	3	30
PICHAC112	1 1/2"	\$ 280.00	3	30
PICHAC2	2"	\$ 460.00	2	20

## Tapa de hierro reforzado para toma domiciliaria



CÓDIGO	DESCRIPCIÓN	PRECIO	INNER
TM1638	30 x 55 cm	\$ 560.00	1
TM1640	23 x 33 cm	\$ 325.00	1

## Cople dresser

Cuerpo de latón



CÓDIGO	DESCRIPCIÓN	PRECIO	INNER	MASTER
CDB12	1/2" 129 g	\$ 80.00	12	120
CDB34	3/4" 173 g	\$ 126.00	15	150
CDB1	1" 325 g	\$ 230.00	6	60

## Válvula check pistón roscada

Cuerpo de latón



CÓDIGO	DESCRIPCIÓN	PRECIO	INNER	MASTER
VCH448	1/2" 192 g	\$ 136.00	10	100
VCH449	3/4" 315 g	\$ 240.00	10	80
VCH980	1" 395 g	\$ 300.00	6	60

## Válvula check pistón columpio

Cuerpo de latón



CÓDIGO	DESCRIPCIÓN	PRECIO	INNER	MASTER
VCHCP12	1/2" 200 g	\$ 145.00	10	100
VCHCP34	3/4" 360 g	\$ 250.00	10	80

## Válvula check tipo italiana 1/2"

Cuerpo de latón



CÓDIGO	DESCRIPCIÓN	PRECIO	INNER	MASTER
VCHTI12	200 g	\$ 110.00	12	120

## Válvula check soldable 1/2"

Cuerpo de latón



CÓDIGO	DESCRIPCIÓN	PRECIO	INNER	MASTER
VCHS12	185 g	\$ 105.00	12	120

El aspecto, empaque, inner o master de los productos puede variar sin previo aviso debido a la innovación continua de nuestras marcas.

**Válvula para gas aguja  
1/4" x 1/4" NPT**

Cuerpo de latón



CÓDIGO	DESCRIPCIÓN	PRECIO	INNER	MASTER
LG1414H	97 g	\$ 56.00	32	256

**Válvula para gas aguja  
1/4" terminal x 1/4" NPT**

Cuerpo de latón



CÓDIGO	DESCRIPCIÓN	PRECIO	INNER	MASTER
LG1414TH	95 g	\$ 56.00	10	100

**Válvula para gas aguja  
3/8" flare x 1/4" NPT**

Cuerpo de latón



CÓDIGO	DESCRIPCIÓN	PRECIO	INNER	MASTER
LG3814FH	95 g	\$ 56.00	32	256

**Válvula para gas aguja  
3/8" x 3/8" flare**

Cuerpo de latón



CÓDIGO	DESCRIPCIÓN	PRECIO	INNER	MASTER
LG3838F	90 g	\$ 56.00	32	256

**Válvula para gas de paso  
3/8" flare x 1/2" NPT**

Cuerpo de latón



CÓDIGO	DESCRIPCIÓN	PRECIO	INNER	MASTER
LG3812FH	98 g	\$ 56.00	32	256

**Válvula para gas  
1/2" flare x 5/16" NPT**

Cuerpo de latón



CÓDIGO	PRECIO	INNER	MASTER
LG51612FH	\$ 56.00	32	256

**Válvula en codo 3/8" NPT x 1/2" flare**

Cuerpo de latón



CÓDIGO	DESC.	PRECIO	INNER	MASTER
LG3812C	108 g	\$ 80.00	15	150

**Tee terminal 3/8" x 3/8" x 3/8"**

Cuerpo de latón



CÓDIGO	PRECIO	INNER	MASTER
TEET38	\$ 40.00	10	300

**Tee flare**

Cuerpo de latón



CÓDIGO	DESCRIPCIÓN	PRECIO	INN.	MAS.
TEEF14	1/4" x 1/4" x 1/4"	\$ 15.00	10	500
TEEF38	3/8" x 3/8" x 3/8"	\$ 42.00	10	300
TEEF516	5/16" x 5/16" x 5/16"	\$ 24.00	10	500

El aspecto, empaque, inner o master de los productos puede variar sin previo aviso debido a la innovación continua de nuestras marcas.

## Tuerca macho izquierda 7/8"

Cuerpo de latón  
Bolsa con 10 piezas



Para pigtail  
punta pool



CÓDIGO	PRECIO UNITARIO	INNER	MASTER
TUEI	\$ 16.00	10	500

## Niple unión

Cuerpo de latón  
Bolsa con 10 piezas



CÓDIGO	DESCRIPCIÓN	PRECIO UNITARIO	INN.	MAS.
NIPU3838	3/8" x 3/8"	\$ 17.50	10	500
NIPU3812	3/8" x 1/2"	\$ 30.00	10	330
NIPU516	5/16" x 5/16"	\$ 16.00	10	300

## Punta pool de 12 cm

Cuerpo de latón  
Bolsa con 6 piezas



CÓDIGO	DESCRIPCIÓN	PRECIO UNITARIO	INNER	MASTER
PPR12	Rosca	\$ 60.00	50	200
PPE12	Espiga	\$ 62.00	50	200

## Tuerca cónica

Cuerpo de latón  
Bolsa con 10 piezas



CÓDIGO	DESCRIPCIÓN	PRECIO UNITARIO	INNER	MASTER
TUEC38	3/8" Larga	\$ 11.00	10	800
TUEC12	1/2"	\$ 16.00	10	600
TUEC14	1/4"	\$ 9.00	10	1500
TUEC316	3/16"	\$ 5.50	10	1000
TUEC516	5/16" Larga	\$ 8.00	10	1000

## Tee soldable rosca al centro 1/2"

Cuerpo de latón



CÓDIGO	PRECIO UNITARIO	INNER	MASTER
TEERC12	\$ 47.00	10	200

## Tapón hembra

Cuerpo de latón  
Bolsa con 10 piezas



CÓDIGO	DESCRIPCIÓN	PRECIO UNITARIO	INN.	MAS.
TAPH14	1/4"	\$ 7.00	10	1500
TAPH38	3/8"	\$ 15.00	10	800
TAPH12	1/2"	\$ 19.00	10	600

## Cople unión 3/8" x 3/8" flare

Cuerpo metálico  
Bolsa con 10 piezas



CÓDIGO	PRECIO UNITARIO	INNER	MASTER
CU38F	\$ 25.00	10	500

## Niple terminal

Cuerpo de latón  
Bolsa con 10 piezas



Rosca macho  
flare

Rosca macho  
NPT



CÓDIGO	DESCRIPCIÓN	PRECIO UNITARIO	INNER	MASTER
NIPT3838	3/8" x 3/8"	\$ 15.00	10	600
NIPT3812	3/8" x 1/2"	\$ 21.00	10	400
NIPT3814	3/8" x 1/4"	\$ 12.00	10	720
NIPT1238	1/2" x 3/8"	\$ 26.00	10	400
NIPT51614	5/16" x 1/4"	\$ 13.50	10	600
NIPT51638	5/16" x 3/8"	\$ 16.50	10	500
NIPT51612	5/16" x 1/2"	\$ 26.50	10	300

## Tee soldable rosca al lado

Cuerpo de latón



Rosca interior  
1/2" soldable



CÓDIGO	PRECIO UNITARIO	INNER	MASTER
TEERL12	\$ 47.00	10	200

## Punta pool 6 cm

Cuerpo de latón  
Bolsa con 10 piezas



CÓDIGO	DESCRIPCIÓN	PRECIO UNITARIO	INNER	MASTER
PPR6	Rosca	\$ 32.00	50	200
PPE6	Espiga	\$ 32.00	50	200

## Niple para calentón 3/8 flare x 1/8 rosca fina

Bolsa con 10 piezas



CÓDIGO	PRECIO UNITARIO	INNER	MASTER
NC3818	\$ 33.00	10	500

## Niple campana

Cuerpo de latón  
Bolsa con 10 piezas



Rosca macho  
flare

Rosca hembra  
flare



CÓDIGO	DESCRIPCIÓN	PRECIO UNITARIO	INNER	MASTER
NIPC3838	3/8" x 3/8"	\$ 12.60	10	600
NIPC3812	3/8" x 1/2"	\$ 17.50	10	400
NIPC3814	3/8" x 1/4"	\$ 11.00	10	720
NIPC1238	1/2" x 3/8"	\$ 24.00	10	400
NIPC51614	5/16" x 1/4"	\$ 14.00	10	600
NIPC14516	1/4" x 5/16"	\$ 15.00	10	600
NIPC51638	5/16" x 3/8"	\$ 15.00	10	600
NIPC51612	5/16" x 1/2"	\$ 18.00	10	300

**Tuerca cónica reducida 1/4" x 3/8"**

Cuerpo de latón  
Bolsa con 10 piezas



CÓDIGO	PRECIO UNITARIO	INNER	MASTER
TUECR1438	\$ 14.00	10	800

**Codo estufa**

Cuerpo de latón



CODE3812



CÓDIGO	DESCRIPCIÓN	PRECIO UNITARIO	INNER	MASTER
CODE3838	3/8" x 3/8"	\$ 30.00	10	400
CODE3812	3/8" 1/2"	\$ 40.00	10	400

**Tuerca con espiga 3/8"**

Cuerpo de latón  
Bolsa con 10 piezas



CÓDIGO	PRECIO UNITARIO	INNER	MASTER
TUEE38	\$ 16.00	10	800

**Cople doble espiga 1/2"**

Cuerpo de latón  
Bolsa con 10 piezas



CÓDIGO	PRECIO UNITARIO	INNER	MASTER
CDEB12	\$ 25.00	10	100

**Conector macho para poliducto**

Cuerpo de latón  
Bolsa con 10 piezas



CÓDIGO	DESC.	PRECIO UNITARIO	INNER	MASTER
CONPRE12	1/2"	\$ 19.00	30	300
CONPRE34	3/4"	\$ 24.00	30	300
CONPRE1	1"	\$ 53.00	30	150

**Conector hembra para poliducto 1/2"**

Cuerpo de latón  
Bolsa con 10 piezas



CÓDIGO	PRECIO UNITARIO	INNER	MASTER
CONPRI12	\$ 27.00	50	300

**Conector macho para poliducto 1/2"**

Cuerpo metálico  
Bolsa con 10 piezas



CÓDIGO	PRECIO UNITARIO	INNER	MASTER
CPRE664	\$ 16.00	50	300

**Conector hembra para poliducto 1/2"**

Cuerpo metálico  
Bolsa con 10 piezas



CÓDIGO	PRECIO UNITARIO	INNER	MASTER
CPRI665	\$ 17.00	50	300

**Niple macho terminal con espiga 3/8"**

Cuerpo de latón  
Bolsa con 10 piezas



CÓDIGO	PRECIO UNITARIO	INNER	MASTER
NIPTE38	\$ 18.00	50	500

**Codo unión flare**

Cuerpo de latón  
Bolsa con 10 piezas



CÓDIGO	DESCRIPCIÓN	PRECIO UNITARIO	INNER	MASTER
CODU3838	3/8" x 3/8"	\$ 30.00	10	400
CODU1414	1/4" x 1/4"	\$ 19.00	10	500

**Codo terminal**

Cuerpo de latón  
Bolsa con 10 piezas



CÓDIGO	DESCRIPCIÓN	PRECIO UNITARIO	INNER	MASTER
CODT3838	3/8" x 3/8"	\$ 31.00	10	420
CODT3812	3/8" x 1/2"	\$ 36.00	10	360

**Niple medidor**

Cuerpo de Nylon



Incluye: empaque plano



CÓDIGO	DESCRIPCIÓN	PRECIO	INNER	MASTER
NMT1060	3/4" x 1"	\$ 38.00	10	250
NMT1061	1/2" x 3/4"	\$ 22.50	10	500
NMT1659	1/2" x 1"	\$ 34.00	10	500

El aspecto, empaque, inner o master de los productos puede variar sin previo aviso debido a la innovación continua de nuestras marcas.

**Niple medidor**  
Cuerpo de latón



Incluye: empaque



CÓDIGO	DESCRIPCIÓN	PRECIO	INNER	MASTER
NMT1234	1/2" x 3/4"	\$ 62.00	10	200
NMT341	3/4" x 1"	\$ 126.00	10	100

**Codo de cobre 90° hembra**



CÓDIGO	DESCRIPCIÓN	PRECIO	INNER	MASTER
CODRI12	1/2"	\$ 27.00	10	280
CODRI34	3/4"	\$ 55.00	10	100

**Codo 90° macho**  
Cuerpo de latón



CÓDIGO	DESCRIPCIÓN	PRECIO	INNER	MASTER
CODRE12	1/2"	\$ 34.00	10	280
CODRE34	3/4"	\$ 74.00	10	100

**Reducción bushing 3/4" x 1/2"**  
Cuerpo de latón  
Bolsa con 10 piezas



CÓDIGO	PRECIO UNITARIO	INNER	MASTER
REDB3412B	\$ 37.00	10	350

**Niple rosca corrida**  
Cuerpo de latón  
Bolsa con 10 piezas



CÓDIGO	DESCRIPCIÓN	PRECIO UNITARIO	INNER	MASTER
NIBR1788	1/8"	\$ 10.00	10	500
NIBR1789	1/4"	\$ 12.00	10	500
NIBR1790	3/8"	\$ 18.00	10	500
NIBR1791	1/2"	\$ 23.00	10	500
NIBR1792	3/4"	\$ 36.00	10	500

**Reducción bushing**  
Cuerpo de latón  
Bolsa con 10 piezas



CÓDIGO	DESCRIPCIÓN	PRECIO UNITARIO	INNER	MASTER
RBBR1793	1/8" x 1/4"	\$ 13.00	10	500
RBBR1794	1/4" x 3/8"	\$ 16.00	10	500
RBBR1795	1/8" x 3/8"	\$ 20.00	10	500
RBBR1796	3/8" x 1/2"	\$ 23.00	10	500
RBBR1797	1/4" x 1/2"	\$ 40.00	10	500
RBBR1798	1/2" x 3/4"	\$ 42.00	10	350

**Adaptador macho de cobre**



CÓDIGO	DESCRIPCIÓN	PRECIO	INNER	MASTER
CONRE12	1/2"	\$ 12.00	10	400
CONRE34	3/4"	\$ 15.70	10	320
CONRE1	1"	\$ 46.00	10	160

**Adaptador hembra de cobre**



CÓDIGO	DESCRIPCIÓN	PRECIO	INNER	MASTER
CONRI12	1/2"	\$ 13.00	10	500
CONRI34	3/4"	\$ 29.00	10	250
CONRI1	1"	\$ 50.00	10	120

**Tuerca unión**  
Cuerpo de latón



CÓDIGO	DESCRIPCIÓN	PRECIO	INNER	MASTER
TUEU12	1/2"	\$ 37.00	10	300
TUEU34	3/4"	\$ 82.00	10	150
TUEU1	1"	\$ 175.00	10	60

**Conector hembra reducido de cobre 1/2" x 3/4"**



CÓDIGO	PRECIO	INNER	MASTER
CONRRI1234	\$ 50.00	10	250

**Conector macho reducido de cobre 1/2" x 3/4"**



CÓDIGO	PRECIO	INNER	MASTER
CONRRE1234	\$ 50.00	10	320

El aspecto, empaque, inner o master de los productos puede variar sin previo aviso debido a la innovación continua de nuestras marcas.

**Termocople para gas**

Longitud:  
595 mm

Diámetro:  
3.2 mm



CÓDIGO	PRECIO	INNER	MASTER
TCG767	\$ 47.00	1	240

**Termopar con piloto**

Longitud:  
595 mm

Diámetro:  
3.2 mm



CÓDIGO	DESCRIPCIÓN	PRECIO	INNER	MASTER
TPGN766	Natural	\$ 113.00	1	180
TPLPG765	Lp	\$ 113.00	1	180

**Punta pool de reducción con empaque y maneral**

Cuerpo metálico



CÓDIGO	DESCRIPCIÓN	PRECIO	INNER	MASTER
PPMZ14	1/4"	\$ 55.00	8	80
PPMZ38	3/8"	\$ 77.00	8	80

**Termostato automático**

Entrada: 1/2" - 14  
HNPT

Salida: 3/8" - 18  
HNPT

Presión máxima:  
3.1 kPa. (31 g/cm<sup>2</sup>)

Temperatura de  
trabajo: 0°C - 85°C

Temperatura de  
corte: 70°C ± 5°C



CÓDIGO	PRECIO	INNER	MASTER
TA1187	\$ 550.00	1	20

**Regulador para gas de 1 vía**

Capacidad de  
flujo: 160,00  
btu/hr

Presión de  
trabajo: 11 WC  
(28 g/cm<sup>2</sup>)

Para gas LP de  
baja presión

Entrada: 3/8"

Salida: 3/8"

Tuerca  
izquierda: 7/8"



CÓDIGO	PRECIO	INNER	MASTER
REG005	\$ 111.00	1	60

**Regulador para gas de 1 vía con maneral**

Capacidad de  
flujo: 160,00  
btu/hr

Presión de  
trabajo: 11 WC  
(28 g/cm<sup>2</sup>)

Para gas LP de  
baja presión

Entrada: 3/8"

Salida: 3/8"

Tuerca  
izquierda: 7/8"



CÓDIGO	PRECIO	INNER	MASTER
REG006	\$ 110.00	1	60

**Encendedor multiusos  
Encendido electrónico**



EC1046



EM1066



CÓDIGO	DESCRIPCIÓN	PRECIO	INN.	MAS.
EC1046	Largo 13 cm	\$ 27.00	12	72
EM1066	Largo 28 cm	\$ 32.00	12	72

**Soplete para gas**

Con regulador  
de flama

Boquilla  
angosta

Boquilla gruesa

Manguera de  
1.5 m

Conector para  
tanques de 2 a  
30 kg



CÓDIGO	DESCRIPCIÓN	PRECIO	INN.	MAS.
SGASLP02	Sin palanca	\$ 335.00	1	20

**Soplete para gas con palanca**

Con regulador  
de flama

Palanca  
reguladora

Boquilla  
angosta

Boquilla gruesa

Manguera de  
1.5 m

Conector para  
tanques de 2 a  
30 kg



CÓDIGO	DESCRIPCIÓN	PRECIO	INN.	MAS.
SGASLP01	Con palanca	\$ 386.00	1	20

El aspecto, empaque, inner o master de los productos puede variar sin previo aviso debido a la innovación continua de nuestras marcas.



Quemador de gas



CÓDIGO	DESC.	PRECIO	INNER	MASTER
QCH1055	2"	\$ 230.00	1	20
QCH1056	4"	\$ 260.00	1	15
QCH1057	6"	\$ 420.00	1	5

Encendedor piedra autógena y repuesto de piedra



CÓDIGO	DESCRIPCIÓN	PRECIO	INNER	MASTER
ENCPA	Encendedor	\$ 40.00	1	100
RPA5	Piedra 5 pz	\$ 26.00	10	80

Válvula para tanque de gas y repuesto maneral con tornillo para válvula de tanque

Cuerpo de latón



CÓDIGO	DESCRIPCIÓN	PRECIO	INNER	MASTER
VTG1050	Válvula	\$ 180.00	1	1
MTG1051	Maneral	\$ 24.00	1	1

Tanque repuesto Bernzomatic 400 gr



CÓDIGO	PRECIO	INNER	MASTER
TANRB	\$ 210.00	1	12

Cartucho de gas butano/propano

220 gr  
Desechable



CÓDIGO	DESCRIPCIÓN	PRECIO UNITARIO	INNER	MASTER
CGLP107	1/4 de vuelta	\$ 49.00	4	12
CGLP108	Rosca de 1/4"	\$ 49.00	4	12

Boquilla para tanque 1/4 de vuelta

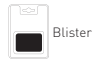
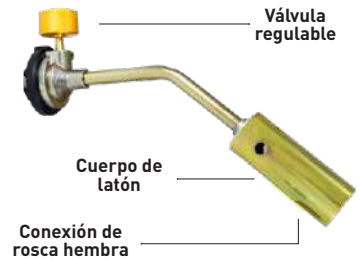

CÓDIGO	PRECIO	INNER	MASTER
BTG109	\$ 110.00	20	80

Boquilla para tanque 1/4" Cuerpo de latón

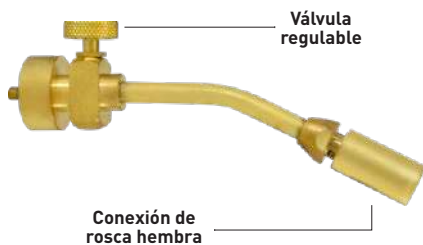

CÓDIGO	PRECIO	INNER	MASTER
BOQTB	\$ 180.00	20	80

Boquilla para tanque 1/2" Cuerpo de latón



CÓDIGO	PRECIO	INNER	MASTER
BTG110	\$ 190.00	20	80

Boquilla para lata de gas roscada 1/4" encendido electrónico

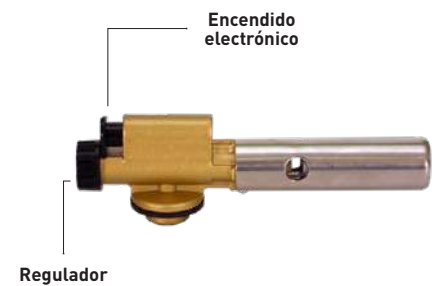

CÓDIGO	PRECIO	INNER	MASTER
BTG111	\$ 250.00	6	36



**Cinta selladora con PTFE**

Bolsa con 10 piezas

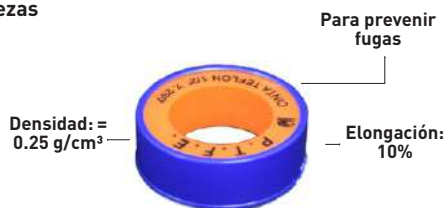

**Cinta selladora con PTFE para gas**

Bolsa con 10 piezas



CÓDIGO	DESCRIPCIÓN	PRECIO UNITARIO	INNER	MASTER
CT12260	1/2" X 260" (6.60m)	\$ 4.20	1	1000
CT12520	1/2" X 520" (13.20m)	\$ 7.60	1	1000
CT34260	3/4" X 260" (6.60m)	\$ 7.40	1	1000
CT34520	3/4" X 520" (13.20m)	\$ 12.40	1	1000

CÓDIGO	DESCRIPCIÓN	PRECIO UNITARIO	INNER	MASTER
CTG12	1/2" x 260" (6.60m)	\$ 11.50	1	1000

**Abrazadera sin fin**

(para uso automotriz, ferretería y hogar)

Resistente a corrosión

Banda de acero inoxidable de 8 mm a 12.7 de grosor (según medida)



Tapa y tornillo de acero al carbón tropicalizado

Tornillo endurecido



CÓDIGO	DESCRIPCIÓN	PRECIO PIEZA	PAQUETE CON	MASTER
ASF04	No. 4 (3/8" a 5/8") 9.5 x 15.8 mm	\$ 2.80	100	2,000
ASF06	No. 6 (7/16" a 3/4") 11.1 x 19 mm	\$ 2.80	100	2,000
ASF08	No. 8 (5/8" a 1") 15.8 x 25.4 mm	\$ 8.00	50	1,000
ASF10	No. 10 (9/16" a 11/16") 14.2 x 17.4 mm	\$ 8.00	50	1,000
ASF12	No. 12 (1/2" a 1 1/4") 12.7 x 31.7 mm	\$ 8.50	50	1,000
ASF16	No. 16 (13/16" a 1 1/2") 20.6 x 38.1 mm	\$ 8.50	50	1,000
ASF20	No. 20 (3/4" a 1 3/4") 19 x 44.4 mm	\$ 8.50	50	500
ASF24	No. 24 (1 1/4" a 2") 31.7 x 50.8 mm	\$ 10.00	50	500
ASF28	No. 28 (1 1/2" a 2 1/4") 38.1 x 57.1 mm	\$ 10.00	25	500
ASF32	No. 32 (1 9/16" a 2 1/2") 39.6 x 63.5 mm	\$ 10.50	25	500
ASF36	No. 36 (1 13/16" a 2 3/4") 46 x 69.8 mm	\$ 10.50	25	500

**Abrazadera 100% acero inoxidable**

(para uso automotriz, ferretería y hogar)

Banda de 8 mm a 12.7 de grosor (según medida)



CÓDIGO	DESCRIPCIÓN	PRECIO PIEZA	PAQUETE CON	MASTER
AAI04	No. 4 (3/8" a 5/8") 9.5 x 15.8 mm	\$ 4.60	100	2,000
AAI06	No. 6 (7/16" a 3/4") 11.1 x 19 mm	\$ 4.60	100	2,000
AAI08	No. 8 (5/8" a 1") 15.8 x 25.4 mm	\$ 9.00	50	1,000
AAI10	No. 10 (9/16" a 11/16") 14.2 x 17.4 mm	\$ 9.00	50	1,000
AAI12	No. 12 (1/2" a 1 1/4") 12.7 x 31.7 mm	\$ 9.50	50	1,000
AAI16	No. 16 (13/16" a 1 1/2") 20.6 x 38.1 mm	\$ 10.50	50	1,000
AAI20	No. 20 (3/4" a 1 3/4") 19 x 44.4 mm	\$ 11.00	50	1,000
AAI24	No. 24 (1 1/4" a 2") 31.7 x 50.8 mm	\$ 11.00	50	1,000
AAI28	No. 28 (1 1/2" a 2 1/4") 38.1 x 57.1 mm	\$ 11.00	25	500
AAI32	No. 32 (1 9/16" a 2 1/2") 39.6 x 63.5 mm	\$ 11.00	25	500
AAI36	No. 36 (1 13/16" a 2 3/4") 46 x 69.8 mm	\$ 12.00	25	500
AAI48	No. 48 (2 9/16" a 3 1/2") 65 x 88.9 mm	\$ 13.00	20	500
AAI56	No. 56 (2" a 4") 50.8 x 101.6 mm	\$ 14.00	20	500
AAI64	No. 64 (3 9/16" a 4 1/2") 90.4 x 114.3 mm	\$ 15.00	20	500
AAI72	No. 72 (4 1/8" a 5") 104.7 x 127 mm	\$ 17.00	20	500
AAI80	No. 80 (4 5/8" a 5 1/2") 117.4 x 139.7 mm	\$ 17.00	20	500
AAI96	No. 96 (5 5/18" a 6 1/2") 142.8 x 165.1 mm	\$ 20.00	20	500

**Boiler de paso instantáneo**

Panel digital  
Encendido electrónico  
Display con temperatura



Especificaciones técnicas:	
70% de ahorro en gas	
Encendido automático	
4.5 L = 1 Servicio	
10 L = 2 Servicios	
Para alta o baja presión	

CÓDIGO	DESCRIPCIÓN	PRECIO	INNER
BPA1678	4.5 L gas L.P	\$ 2,050.00	1
BPA1679	10 L gas L.P.	\$ 4,180.00	1
BPA1680	4.5 L gas natural	\$ 2,050.00	1
BPA1681	10 L gas natural	\$ 4,180.00	1

**Cilindro para gas 9 Kg**



Incluye válvula  
VTG1050



CARACTERÍSTICAS	
Fabricado en acero microaleado	
Capacidad volumétrica: 21.36 L ± 1 %	
Pintura en polvo horneada tipo poliéster	

CÓDIGO	PRECIO	INNER
CG9KG	\$ 1,200.00	1

**Calentador de gas 3 radiantes**

No incluye tanque para gas



**NOTA**

El calentador cuenta con dispositivos de seguridad los cuales se activarán si:  
- El espacio en donde se encuentra es muy pequeño.  
- La ventilación no es suficiente.  
- Se encuentra en condiciones inseguras.



Especificaciones técnicas:	
Descripción:	Calentador de gas móvil
Entrada de calor:	4200W
Tipo de gas:	L.P.
Categoría del gas:	3B/P (30)
Presión de gas:	(28-30) mbar
Rango de calor:	3 niveles (4,200W, 2,800W, 1,400W)
Tipo de ignición:	Electrónico
Tipo de extractor:	Natural
Consumo de gas:	292 g/h al máximo
Medidas:	27" x 15" x 13"
Peso neto:	10 kg

CÓDIGO	PRECIO	INNER
CGR03	\$ 2,900.00	1

**Cilindro para gas 9 Kg**



Incluye  
válvula de  
seguridad



CARACTERÍSTICAS	
Fabricado en acero microaleado	
Capacidad volumétrica: 21.36 L ± 1 %	
Pintura en polvo horneada tipo poliéster	

CÓDIGO	PRECIO	INNER
CGS9KG	\$ 1,350.00	1

El aspecto, empaque, inner o master de los productos puede variar sin previo aviso debido a la innovación continua de nuestras marcas.



Presión Máxima  
**20°C**  
2400 Kpa / 345 psi



Presión Máxima  
**95°C**  
620 Kpa / 90 psi

# Línea PPR



Propiedades Anti-bacterianas



Alta resistencia al impacto



Conducción de agua fría y caliente

## Codo PP-R 90°

Bolsa con 10 piezas



CPPR863  
CPPR864



CÓDIGO	DESCRIPCIÓN	PRECIO UNITARIO	INNER	MASTER
CPPR863	20 mm	\$ 3.70	10	430
CPPR864	25 mm	\$ 5.00	10	300
CPPR865	32 mm	\$ 11.00	5	165

## Codo PP-R 45°

Bolsa con 10 piezas



CÓDIGO	DESCRIPCIÓN	PRECIO UNITARIO	INNER	MASTER
CPPR866	20 mm	\$ 5.00	10	510
CPPR867	25 mm	\$ 7.00	10	360
CPPR868	32 mm	\$ 11.00	10	200

## Codo reducido PP-R

Bolsa con 10 piezas



CÓDIGO	DESCRIPCIÓN	PRECIO UNITARIO	INNER	MASTER
CPPR872	25 - 22 mm	\$ 8.00	10	420
CPPR873	32 - 25 mm	\$ 12.50	10	240

## Cople PP-R

Bolsa con 10 piezas



CÓDIGO	DESCRIPCIÓN	PRECIO UNITARIO	INNER	MASTER
CPPR860	20 mm	\$ 2.50	10	770
CPPR861	25 mm	\$ 4.50	10	470
CPPR862	32 mm	\$ 7.50	10	290

## Cople reducido PP-R

Bolsa con 10 piezas



CPPR876  
CPPR877



CÓDIGO	DESCRIPCIÓN	PRECIO UNITARIO	INNER	MASTER
CPPR876	25 - 20 mm	\$ 3.50	10	510
CPPR877	32 - 20 mm	\$ 6.00	10	390
CPPR878	32 - 25 mm	\$ 7.50	10	290

## Tee PP-R

Bolsa con 10 piezas



TPPR870  
TPPR871



CÓDIGO	DESCRIPCIÓN	PRECIO UNITARIO	INNER	MASTER
TPPR869	20 mm	\$ 5.20	10	320
TPPR870	25 mm	\$ 7.50	10	200
TPPR871	32 mm	\$ 14.00	10	120

## Tee reducida PP-R

Bolsa con 10 piezas



CÓDIGO	DESCRIPCIÓN	PRECIO UNITARIO	INNER	MASTER
TPPR874	25 - 20 mm	\$ 9.50	10	230
TPPR875	32 - 25 mm	\$ 17.00	10	150

## Tapón capucha PP-R

Bolsa con 10 piezas



CÓDIGO	DESCRIPCIÓN	PRECIO UNITARIO	INNER	MASTER
TPPR879	20 mm	\$ 2.50	10	1250
TPPR880	25 mm	\$ 4.50	10	730
TPPR881	32 mm	\$ 7.00	10	500

## Tuerca unión PP-R

Bolsa con 10 piezas



CÓDIGO	DESCRIPCIÓN	PRECIO UNITARIO	INNER	MASTER
TPPR989	20 mm	\$ 15.00	10	250
TPPR990	25 mm	\$ 20.00	10	170
TPPR898	32 mm	\$ 35.00	10	110

El aspecto, empaque, inner o master de los productos puede variar sin previo aviso debido a la innovación continua de nuestras marcas.

PPR

**Adaptador hembra PP-R con inserto de latón**

Bolsa con 10 piezas



CPPR1040  
CPPR882



CÓDIGO	DESCRIPCIÓN	PRECIO UNITARIO	INN.	MAS.
CPPR882	20 mm a 1/2"	\$ 25.00	10	220
CPPR883	20 mm a 3/4"	\$ 35.00	10	190
CPPR884	25 mm a 1/2"	\$ 37.00	10	200
CPPR1040	25 mm a 3/4"	\$ 37.00	10	150
CPPR1041	32 mm a 1"	\$ 85.00	10	90

**Adaptador macho PP-R con inserto de latón**

Bolsa con 10 piezas



CPPR885



CÓDIGO	DESCRIPCIÓN	PRECIO UNITARIO	INN.	MAS.
CPPR885	20 mm a 1/2"	\$ 32.00	10	170
CPPR886	20 mm a 3/4"	\$ 45.00	10	110
CPPR887	25 mm a 1/2"	\$ 37.00	10	160
CPPR1042	25 mm a 3/4"	\$ 48.00	10	120
CPPR1043	32 mm a 1"	\$ 95.00	10	80

**Codo hembra de oreja PP-R con inserto de latón 90° 20 mm a 1/2"**

Bolsa con 10 piezas



CÓDIGO	PRECIO UNITARIO	INNER	MASTER
CPPR893	\$ 33.00	10	130

**Codo reducido hembra PP-R con inserto de latón**

Bolsa con 10 piezas



CPPR888



CÓDIGO	DESCRIPCIÓN	PRECIO UNITARIO	INN.	MAS.
CPPR888	20 mm a 1/2"	\$ 30.00	10	150
CPPR889	20 mm a 3/4"	\$ 44.00	10	110

**Codo reducido macho PP-R con inserto de latón**

Bolsa con 10 piezas



CÓDIGO	DESCRIPCIÓN	PRECIO UNITARIO	INN.	MAS.
CPPR890	25 mm a 1/2"	\$ 50.00	10	110
CPPR891	32 mm a 1/2"	\$ 57.00	10	80
CPPR892	32 mm a 3/4"	\$ 73.00	10	70

**Tee reducida hembra PP-R con inserto de latón**

Bolsa con 10 piezas



TPPR894



CÓDIGO	DESCRIPCIÓN	PRECIO UNITARIO	INN.	MAS.
TPPR894	20 mm a 1/2"	\$ 30.00	10	130
TPPR988	20 mm a 3/4"	\$ 50.00	10	120

**Válvula esfera PP-R**

Presión máxima a 20°C: 24 kg/cm2 (341 psi)

Presión máxima a 95°C: 6 kg/cm2 (85 psi)



Caja a color

CÓDIGO	DESCRIPCIÓN	PRECIO	INNER	MASTER
VPPR899	20 mm	\$ 20.00	1	160
VPPR890	25 mm	\$ 30.00	1	90
VPPR891	32 mm	\$ 50.00	1	63

**Juego de llave para empotrar con maneral y chapetón metálico vástago PP-R 20 mm**

Presión máxima a 20°C: 2400 Kpa/345 psi

Presión máxima a 95°C: 620 Kpa/90 psi



Caja a color

CÓDIGO	PRECIO	INNER	MASTER
JPPR892	\$ 540.00	1	20

**Tubo PP-R 4 m**



CÓDIGO	DESC.	TUBOS POR ATADO	PRECIO	INN.	MAS.
TPPR895	20 mm	30	\$ 76.00	1	30
TPPR896	25 mm	20	\$ 137.00	1	20
TPPR897	32 mm	14	\$ 220.00	1	14

**Kit de termofusión con dados 20 mm a 63 mm**

110 V~, 600 W

Incluye:

1 Estuche metálico

1 Termofusor

1 Base de termofusor

6 Dados: 63, 50, 40, 32, 25 y 20 mm

1 Llave allen

2 Tornillos



Contenedor metálico etiqueta

CÓDIGO	PRECIO	INNER	MASTER
KPPR893	\$ 850.00	1	4

**Kit de termofusión con dados 20 mm a 63 mm profesional**

110 - 220 V~, 1,500 W

Incluye:

6 Dados: 63, 50, 40, 33, 25 y 20 mm

1 Cortatubo

1 Nivel

1 Par de guantes de carnauba

1 Flexómetro

1 Desarmador

1 Llave allen

6 Tornillos para dados

1 Estuche metálico



Contenedor metálico etiqueta

CÓDIGO	PRECIO	INNER	MASTER
KPPR894	\$ 2,100.00	1	4

El aspecto, empaque, inner o master de los productos puede variar sin previo aviso debido a la innovación continua de nuestras marcas.



400 psi (28 kgf/cm<sup>2</sup>) @ 23° C  
125 psi (7 kgf/cm<sup>2</sup>) @ 80° C

# Línea CPVC



Resistente a altas temperaturas



No tóxico



Autoextinguible No propaga flama

## Codo CPVC 90°

Bolsa con 10 piezas



CÓDIGO	DESCRIPCIÓN	PRECIO UNITARIO	INN.	MAS.
CCPVC1290	1/2"	\$ 2.10	10	1,600
CCPVC3490	3/4"	\$ 3.50	10	650
CCPVC190	1"	\$ 9.50	10	290
CCPVC11490	1 1/4"	\$ 18.00	10	170
CCPVC11290	1 1/2"	\$ 28.00	10	100
CCPVC290	2"	\$ 65.00	5	45

## Codo CPVC 45°

Bolsa con 10 piezas



CÓDIGO	DESCRIPCIÓN	PRECIO UNITARIO	INN.	MAS.
CCPVC1245	1/2"	\$ 2.10	10	1,800
CCPVC3445	3/4"	\$ 4.00	10	750
CCPVC145	1"	\$ 9.00	10	340
CCPVC11445	1 1/4"	\$ 18.00	10	200
CCPVC11245	1 1/2"	\$ 28.00	10	120
CCPVC245	2"	\$ 65.00	8	56

## Cople CPVC

Bolsa con 10 piezas



CÓDIGO	DESCRIPCIÓN	PRECIO UNITARIO	INN.	MAS.
COCPCVC12	1/2"	\$ 1.60	10	2,500
COCPCVC34	3/4"	\$ 2.25	10	1,000
COCPCVC1	1"	\$ 6.00	10	450
COCPCVC114	1 1/4"	\$ 12.50	10	270
COCPCVC112	1 1/2"	\$ 20.00	10	200
COCPCVC2	2"	\$ 40.00	12	96

## Tee CPVC

Bolsa con 10 piezas



CÓDIGO	DESC.	PRECIO UNITARIO	INN.	MAS.
TECPVC12	1/2"	\$ 2.80	10	1,050
TECPVC34	3/4"	\$ 5.00	10	400
TECPVC1	1"	\$ 11.50	10	200
TECPVC114	1 1/4"	\$ 26.00	10	100
TECPVC112	1 1/2"	\$ 40.00	5	60
TECPVC2	2"	\$ 82.00	5	40

## Adaptador macho CPVC

Bolsa con 10 piezas



CÓDIGO	DESC.	PRECIO UNITARIO	INN.	MAS.
ARECPVC12	1/2"	\$ 2.30	10	1,700
ARECPVC34	3/4"	\$ 3.50	10	950
ARECPVC1	1"	\$ 7.50	10	470
ARECPVC114	1 1/4"	\$ 15.00	10	280
ARECPVC112	1 1/2"	\$ 21.00	10	180
ARECPVC2	2"	\$ 42.00	8	96

## Adaptador hembra CPVC

Bolsa con 10 piezas



CÓDIGO	DESC.	PRECIO UNITARIO	INN.	MAS.
ARICPVC12	1/2" Empaque	\$ 3.50	10	1,250
ARICPVC34	3/4" Empaque	\$ 5.00	10	700
ARICPVC1	1" Empaque	\$ 10.00	10	370
ARICPVC114	1 1/4" Empaque	\$ 18.50	10	210
ARICPVC112	1 1/2" Empaque	\$ 26.00	10	160
ARICPVC2	2" Empaque	\$ 55.00	5	150

## Tee reducida CPVC

Bolsa con 10 piezas



CÓDIGO	DESCRIPCIÓN	PRECIO UNITARIO	INN.	MAS.
TRCPVC3412	3/4" x 1/2"	\$ 7.50	10	550
TRCPVC112	1" x 1/2"	\$ 12.00	10	300
TRCPVC134	1" x 3/4"	\$ 15.00	10	250
TRCPVC11434	1 1/4" x 3/4"	\$ 22.00	10	160
TRCPVC1141	1 1/4" x 1"	\$ 26.00	10	140
TRCPVC1121	1 1/2" x 1"	\$ 36.00	10	90
TRCPVC112114	1 1/2" x 1" 1/4"	\$ 38.00	10	80
TRCPVC2114	2" x 1 1/4"	\$ 66.00	10	50
TRCPVC2112	2" x 1 1/2"	\$ 85.00	10	50

## Grapa CPVC

Bolsa con 10 piezas



CÓDIGO	DESCRIPCIÓN	PRECIO UNITARIO	INN.	MAS.
GCPVC12	1/2"	\$ 1.00	10	6,000
GCPVC34	3/4"	\$ 1.30	10	3,600
GCPVC1	1"	\$ 1.50	10	2,500
GCPVC114	1 1/4"	\$ 2.20	10	1,300
GCPVC112	1 1/2"	\$ 3.80	10	850
GCPVC2	2"	\$ 4.50	10	550

## Reducción campana CPVC

Bolsa con 10 piezas



CÓDIGO	DESCRIPCIÓN	PRECIO UNITARIO	INN.	MAS.
RCCPVC3412	3/4" x 1/2"	\$ 4.20	10	1,150
RCCPVC112	1" x 1/2"	\$ 6.00	10	630
RCCPVC134	1" x 3/4"	\$ 7.00	10	600
RCCPVC1141	1 1/4" x 1"	\$ 14.00	10	350
RCCPVC1121	1 1/2" x 1"	\$ 18.00	10	300
RCCPVC2114	2" x 1 1/4"	\$ 44.00	10	128
RCCPVC2112	2" x 1 1/2"	\$ 45.00	10	128
RCCPVC11434	1 1/4" x 3/4"	\$ 10.00	10	380
RCCPVC112114	1 1/2" x 1 1/4"	\$ 18.00	10	200

El aspecto, empaque, inner o master de los productos puede variar sin previo aviso debido a la innovación continua de nuestras marcas.

LÍNEA CPVC

CPVC

## Reducción bushing CPVC

Bolsa con 10 piezas



CÓDIGO	DESCRIPCIÓN	PRECIO UNITARIO	INN.	MAS.
RBCPVC3412	3/4" x 1/2"	\$ 2.10	100	2,300
RBCPVC112	1" x 1/2"	\$ 5.00	10	1,050
RBCPVC134	1" x 3/4"	\$ 4.00	10	950
RBCPVC11434	1 1/4" x 3/4"	\$ 9.00	10	600
RBCPVC1141	1 1/4" x 1"	\$ 9.00	10	550
RBCPVC1121	1 1/2" x 1"	\$ 14.50	10	380
RBCPVC112114	1 1/2" x 1" 1/4"	\$ 17.00	10	380
RBCPVC2114	2" x 1 1/4"	\$ 35.00	10	200
RBCPVC2112	2" x 1 1/2"	\$ 30.00	10	200
RBCPVC11412	1/4" x 1/2"	\$ 9.00	10	600
RBCPVC11212	1 1/2" x 1/2"	\$ 14.00	10	380
RBCPVC11234	1 1/2" x 3/4"	\$ 16.00	10	380
RBCPVC212	2" x 1/2"	\$ 28.00	10	200
RBCPVC234	2" x 3/4"	\$ 30.00	10	100
RBCPVC21	2" x 1"	\$ 32.00	10	600

## Cople de reparación CPVC

Bolsa con 10 piezas



CÓDIGO	DESCRIPCIÓN	PRECIO UNITARIO	INN.	MAS.
CRLCPVC12	1/2"	\$ 10.00	10	650
CRLCPVC34	3/4"	\$ 16.00	10	400
CRLCPVC1	1"	\$ 19.00	10	270

## Cople con orejas CPVC 1/2"

Bolsa con 10 piezas



CÓDIGO	PRECIO UNITARIO	INNER	MASTER
CCOCPVC12	\$ 11.00	10	430

## Codo interior/exterior CPVC

Bolsa con 10 piezas



CÓDIGO	DESCRIPCIÓN	PRECIO UNITARIO	INN.	MAS.
CEICPVC12	1/2" x 1/2"	\$ 4.20	10	1,350
CEICPVC34	3/4" x 1/2"	\$ 9.00	10	600
CEICPVC1	1" x 3/4"	\$ 16.00	10	300

## Tapón capucha CPVC

Bolsa con 10 piezas



CÓDIGO	DESCRIPCIÓN	PRECIO UNITARIO	INN.	MAS.
TACPVC12	1/2"	\$ 1.40	10	4,500
TACPVC34	3/4"	\$ 2.20	10	1,650
TACPVC1	1"	\$ 5.00	10	800

## Tuerca unión CPVC

Bolsa con 10 piezas



CÓDIGO	DESCRIPCIÓN	PRECIO UNITARIO	INN.	MAS.
TUCPVC12	1/2"	\$ 9.00	10	600
TUCPVC34	3/4"	\$ 21.00	10	330
TUCPVC1	1"	\$ 35.00	10	200
TUCPVC114	1 1/4"	\$ 50.00	10	120
TUCPVC112	1 1/2"	\$ 65.00	10	70
TUCPVC2	2"	\$ 122.00	5	40

## Cruz CPVC

Bolsa con 10 piezas



CÓDIGO	DESCRIPCIÓN	PRECIO UNITARIO	INN.	MAS.
CZCPVC1769	1/2"	\$ 6.70	10	750
CZCPVC1770	3/4"	\$ 11.00	10	300
CZCPVC1771	1"	\$ 18.00	10	150

## Tee reducida con inserto de latón macho

Bolsa con 10 piezas



CÓDIGO	DESCRIPCIÓN	PRECIO UNITARIO	INN.	MAS.
TRBM1029	1" x 1/2" x 1"	\$ 45.00	5	90
TRBM1030	1" x 3/4" x 1"	\$ 58.00	5	120

## Adaptador hembra CPVC con inserto de latón

Bolsa con 10 piezas



CÓDIGO	DESCRIPCIÓN	PRECIO UNITARIO	INN.	MAS.
ARIBCPVC12	1/2"	\$ 30.00	10	425
ARIBCPVC34	3/4"	\$ 40.00	10	240
ARIBCPVC1	1"	\$ 90.00	10	130
ARIBRCPVC3412	Red 3/4" - 1/2"	\$ 34.00	10	330
ARIBRCPVC112	Red 1" - 1/2"	\$ 36.00	10	300

## Adaptador macho CPVC con inserto de latón

Bolsa con 10 piezas



CÓDIGO	DESCRIPCIÓN	PRECIO UNITARIO	INN.	MAS.
AREBCPVC12	1/2"	\$ 37.00	10	330
AREBCPVC34	3/4"	\$ 49.00	10	180
AREBCPVC1	1"	\$ 88.00	10	100
AREBCPVC3412	Red 3/4" - 1/2"	\$ 42.00	10	240

## Cople dresser CPVC

Bolsa con 10 piezas



CÓDIGO	DESCRIPCIÓN	PRECIO UNITARIO	INN.	MAS.
CDC1026	1/2"	\$ 24.00	10	250
CDC1027	3/4"	\$ 35.00	10	150
CDC1028	1"	\$ 50.00	10	100

**Codo hembra CPVC con inserto de latón**

Bolsa con 10 piezas



CBCPVC1212  
CRBCPVC3434



CÓDIGO	DESCRIPCIÓN	PRECIO UNITARIO	INN.	MAS.
CBCPVC1212	1/2" x 1/2"	\$ 28.00	5	325
CRBCPVC3412	3/4" x 1/2"	\$ 42.00	10	250
CBCPVC3434	3/4" x 3/4"	\$ 39.00	10	150
CRBCPVC112	1" x 1/2"	\$ 40.00	10	160
CRBCPVC134	1" x 3/4"	\$ 45.00	10	140

**Codo macho CPVC con inserto de latón**

Bolsa con 10 piezas



CÓDIGO	DESCRIPCIÓN	PRECIO UNITARIO	INN.	MAS.
CBM1031	1/2"	\$ 38.00	10	200
CBM1032	3/4"	\$ 55.00	10	120
CRBM1033	Red 1/2" - 1"	\$ 47.00	10	125
CRBM1034	Red 3/4" - 1"	\$ 58.00	10	110

**Tee reducida con inserto de latón CPVC**

Bolsa con 10 piezas



CÓDIGO	DESCRIPCIÓN	PRECIO UNITARIO	INN.	MAS.
TRBCPVC112	1" x 1/2" x 1/2"	\$ 39.00	10	110
TRBCPVC3412	1/2" x 3/4" x 1/2"	\$ 37.00	10	150
TRBCPVC134	3/4" x 1" x 3/4"	\$ 42.00	10	100

**Llave de retención CPVC 1/2"**



CÓDIGO	PRECIO	INNER	MASTER
LLARCPVC12	\$ 30.00	1	280

**Válvula de paso CPVC 1/2"**



CÓDIGO	PRECIO	INNER	MASTER
LLALCPVC12	\$ 34.00	1	200

**Llave de paso CPVC 1/2"**



CÓDIGO	PRECIO	INNER	MASTER
LLAPCPVC12	\$ 40.00	1	200

**Llave para tinaco CPVC**



CÓDIGO	DESC.	PRECIO	INNER	MASTER
LLATCPVC34	3/4"	\$ 72.00	1	160
LLATCPVC1	1"	\$ 120.00	1	90

**Juego de llaves para empotrar CPVC 1/2"**

Presión de trabajo a 23°C:  
28 kgf/cm2 (398 psi)

Presión de trabajo a 82°C:  
7 kgf/cm2 (100 psi)

Cartucho de latón

Discos cerámicos



1/4 de vuelta



CÓDIGO	DESC.	PRECIO	INNER	MASTER
JECPVC12	1/2"	\$ 188.00	1	72

**Válvula esfera soldable CPVC 150 psi**



CÓDIGO	DESCRIPCIÓN	PRECIO	INNER	MASTER
VBPCPVC12	1/2"	\$ 32.00	1	220
VBPCPVC34	3/4"	\$ 49.00	1	150
VBCPVC1	1"	\$ 90.00	1	220
VBCPVC114	1 1/4"	\$ 140.00	1	60
VBCPVC112	1 1/2"	\$ 195.00	1	40
VBCPVC2	2"	\$ 390.00	1	20



# Tubo de CPVC



Resistente a cambios climáticos



RD 13.5  
RD 11  
3.05 mm - 610 mm



Resistencia a la alta corrosión



Temperatura de trabajo  
-20° C a 82° C  
en operación doméstica normal



400 psi (28 kgf/cm<sup>2</sup>) @ 23° C  
125 psi (7 kgf/cm<sup>2</sup>) @ 80° C



Resistente a altas temperaturas



No tóxico



Autoextinguible  
No propaga flama

## RD-13.5



TCPVC31  
TCPVC61



CÓDIGO	DESCRIPCIÓN	PRECIO	ATADO
TCPVC312	1/2" 3.05 m	\$ 44.00	50
TCPVC334	3/4" 3.05 m	\$ 78.00	40
TCPVC31	1" 3.05 m	\$ 135.00	25
TCPVC3114	1 1/4" 3.05 m	\$ 260.00	15
TCPVC3112	1 1/2" 3.05 m	\$ 420.00	10
TCPVC32	2" 3.05 m	\$ 690.00	5
TCPVC612	1/2" 6.10 m	\$ 88.00	50
TCPVC634	3/4" 6.10 m	\$ 156.00	40
TCPVC61	1" 6.10 m	\$ 270.00	25
TCPVC6114	1 1/4" 6.10 m	\$ 520.00	15
TCPVC6112	1 1/2" 6.10 m	\$ 840.00	10
TCPVC62	2" 6.10 m	\$ 1,380.00	5

## RD-11

Fabricación sobre pedido



TCPVC195  
TCPVC196  
TCPVC197  
TCPVC198  
TCPVC199  
TCPVC1910



CÓDIGO	DESCRIPCIÓN	PRECIO	ATADO
TCPVC1664	1/2" 3.05 m	\$ 52.00	50
TCPVC1665	3/4" 3.05 m	\$ 92.00	40
TCPVC1666	1" 3.05 m	\$ 150.00	25
TCPVC1905	1 1/4" 3.05 m	\$ 230.00	15
TCPVC1906	1 1/2" 3.05 m	\$ 340.00	10
TCPVC1907	2" 3.05 m	\$ 590.00	5
TCPVC1667	1/2" 6.10 m	\$ 104.00	50
TCPVC1668	3/4" 6.10 m	\$ 184.00	40
TCPVC1669	1" 6.10 m	\$ 300.00	25
TCPVC1908	1 1/4" 6.10 m	\$ 460.00	15
TCPVC1909	1 1/2" 6.10 m	\$ 680.00	10
TCPVC1910	2" 6.10 m	\$ 1,180.00	5

## PRODUCTOS PVC

### Cople dresser PVC

Empaque blanco para cobre y CPVC

Empaque negro para galvanizado



Roscable



CÓDIGO	DESCRIPCIÓN	PRECIO	INNER	MASTER
CDPE12	1/2"	\$ 27.00	10	200
CDPE34	3/4"	\$ 41.00	10	200
CDPE1	1"	\$ 55.00	10	200

### Válvula esfera roscable de PVC 200 psi



CÓDIGO	DESC.	PRECIO	INNER	MASTER
LLAPPR12	1/2"	\$ 20.00	1	200
LLAPPR34	3/4"	\$ 33.00	1	200
LLAPPR1	1"	\$ 47.00	1	100
LLAPPR114	1 1/4"	\$ 66.00	1	50
LLAPPR112	1 1/2"	\$ 88.00	1	50
LLAPPR2	2"	\$ 143.00	1	32

### Válvula esfera soldable de PVC 200 psi



CÓDIGO	DESCRIPCIÓN	PRECIO	INNER	MASTER
LLAPPS12	1/2"	\$ 20.00	1	200
LLAPPS34	3/4"	\$ 33.00	1	200
LLAPPS1	1"	\$ 47.00	1	100
LLAPPS114	1 1/4"	\$ 66.00	1	60
LLAPPS112	1 1/2"	\$ 88.00	1	50
LLAPPS2	2"	\$ 143.00	1	30

# Línea de CARTUCHOS



CERÁMICOS

1/4 de vuelta



CERÁMICOS  
MONOMANDO



COMPRESIÓN

Vuelta completa



PUSH  
3 segundos



CASCABEL  
MONOMANDO

## Niple para vástago (10 Piezas)



Cuerpo de ABS



CÓDIGO	PRECIO	INNER	MASTER
NIPV	\$ 7.00	50	500

## Cartucho Cuerpo de latón

Cerámicos

Para mezcladoras:  
MEZF8046BN  
MEZF8046C



1/4 de vuelta



CÓDIGO	DESCRIPCIÓN	PRECIO	INNER	MASTER
V3002	Agua fría	\$ 56.00	1	100
V3002R	Agua Caliente	\$ 56.00	1	100

## Cartucho Cuerpo de latón

Cerámicos

Cartucho compatible con las marcas de más presencia en el mercado



1/4 de vuelta



CÓDIGO	DESCRIPCIÓN	PRECIO	INNER	MASTER
V3003	Agua fría	\$ 56.00	1	100
V3003R	Agua caliente	\$ 56.00	1	100

## Cartucho Cuerpo de latón

De compresión

Para mezcladoras:  
MEZF8011  
MEZF8012  
MEZF110PP



Vuelta completa



CÓDIGO	DESCRIPCIÓN	PRECIO	INNER	MASTER
V3004	Agua fría	\$ 56.00	1	100

## Cartucho Cuerpo metálico

Para mezcladoras:  
MEZL119  
MEZL120  
MEZL119BN  
MEZRT18201  
MEZF149  
MEZF149S



CÓDIGO	PRECIO	INNER	MASTER
V3005	\$ 78.00	1	200

## Cartucho Cuerpo de latón

Cerámicos

Para mezcladoras:  
MEZF9220



1/4 de vuelta



CÓDIGO	DESCRIPCIÓN	PRECIO	INNER	MASTER
V3006	Agua fría	\$ 64.00	1	100
V3006R	Agua caliente	\$ 64.00	1	100

## Cartucho Cuerpo de ABS

Cerámicos

Para mezcladora:  
MEZF1411CB



1/4 de vuelta



CÓDIGO	DESCRIPCIÓN	PRECIO	INNER	MASTER
V3007	Agua fría	\$ 38.00	1	10
V3007R	Agua caliente	\$ 38.00	1	10

## Cartucho Cuerpo de latón

Cerámicos

Para mezcladora:  
MEZL117



1/4 de vuelta



CÓDIGO	DESCRIPCIÓN	PRECIO	INNER	MASTER
V3010	Agua fría	\$ 45.00	1	100
V3010R	Agua caliente	\$ 45.00	1	100

## Cartucho Cuerpo de latón

Cerámicos

Para mezcladora:  
MEZL8032



1/4 de vuelta



CÓDIGO	DESCRIPCIÓN	PRECIO	INNER	MASTER
V3011	Agua fría	\$ 56.00	1	200
V3011R	Agua caliente	\$ 56.00	1	200

LÍNEA DE CARTUCHOS

CARTUCHOS

El aspecto, empaque, inner o master de los productos puede variar sin previo aviso debido a la innovación continua de nuestras marcas.

## Cartucho para mezcladora con maneral

Cuerpo de ABS

Para mezcladora:  
MEZL112  
MEZL1473



CÓDIGO	DESCRIPCIÓN	PRECIO	INNER	MASTER
V3024M	Agua fría	\$ 200.00	1	125

## Cartucho

Cuerpo de latón

Cerámicos

Para mezcladora:  
MEZF151A



CÓDIGO	DESCRIPCIÓN	PRECIO	INNER	MASTER
V3016	Agua fría	\$ 58.00	1	200
V3016R	Agua caliente	\$ 58.00	1	200

## Cartucho

Cuerpo de latón

Cerámicos

Para mezcladora:  
MEZB8016  
MEZL8032

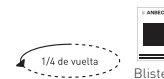

CÓDIGO	DESCRIPCIÓN	PRECIO	INNER	MASTER
V3017	Agua fría	\$ 56.00	1	200
V3017R	Agua caliente	\$ 56.00	1	200

## Cartucho

Cuerpo de ABS

Cerámicos

Para mezcladoras:  
MEZF458C MEZF8082BN  
MEZF458BN MEZF8084C  
MEZF459C MEZF8084BN  
MEZF459BN MEZF795C  
MEZF457C MEZF474  
MEZF457BN  
MEZF1761C  
MEZF1761BN  
MEZF1762  
MEZL697  
MEZR2005BN  
MEZR2005  
MEZF8083C  
MEZF8083BN  
MEZF8082C



CÓDIGO	DESCRIPCIÓN	PRECIO	INNER	MASTER
V3022	Agua fría	\$ 77.00	1	500

## Cartucho

Cuerpo de ABS

Cerámicos

Para mezcladoras:  
MEZR1238C  
MEZRT2008C  
MEZRT2008BN



CÓDIGO	DESCRIPCIÓN	PRECIO	INNER	MASTER
V3021	Agua fría	\$ 77.00	1	300

## Cartucho

Cuerpo de latón

Cerámicos

Para mezcladoras:  
MEZF8090 MEZTY849CK  
MEZF8041BN MEZL8027  
MEZL4009 MEZL0403C  
MEZL696 MEZL8041  
MEZTY847CK MEZL4060C  
MEZL8041CD MEZL8028C  
MEZL8041BN MEZ0403CBH8  
MEZL0404CBH6 MEZL4059BN  
MEZTY842WCC1 MEZL8024  
MEZB4003 MEZTY848CK  
MEZB4140 MEZL4010  
MEZB8020 MEZL105PP  
MEZF8010 MEZL8019  
MEZF8015 MEZL4033  
MEZF8033 MEZB1090  
MEZF8204 MEZTY846  
MEZF8005 MEZL4077  
MEZF8050  
MEZLMB135  
MEZL8042



CÓDIGO	DESCRIPCIÓN	PRECIO	INNER	MASTER
V3018	Agua fría	\$ 57.00	1	250
V3018R	Agua caliente	\$ 57.00	1	100

## Cartucho

Cuerpo de latón

Cerámicos

Para mezcladoras:  
MEZL4036  
MEZB1080  
MEZB4136  
MEZB4096  
MEZF8080  
MEZF8047  
MEZB107KCP2  
MEZB8029  
MEZF8051  
MEZF8055  
MEZF8064  
MEZF8088  
MEZL791BN  
MEZL791C



CÓDIGO	DESCRIPCIÓN	PRECIO	INNER	MASTER
V3019	Agua fría	\$ 57.00	1	100
V3019R	Agua caliente	\$ 57.00	1	100

## Cartucho

Cuerpo de latón

Cerámicos

Para mezcladoras:  
MEZB4065BN  
MEZB4065C  
MEZL4001



CÓDIGO	DESCRIPCIÓN	PRECIO	INNER	MASTER
V3020	Agua fría	\$ 58.00	1	100
V3020R	Agua caliente	\$ 58.00	1	100

## Cartucho

Cuerpo de latón

De compresión

Para fregador y lavabo bronce

Cartucho compatible con las marcas de más presencia en el mercado



CÓDIGO	DESCRIPCIÓN	PRECIO	INNER	MASTER
V3025	Agua fría	\$ 46.00	1	200

**Cartucho**

Cuerpo de latón

De compresión

Para llave de empotrar:

- JE001
- JE002
- JE003
- JE004

Cartucho compatible con las marcas de más presencia en el mercado



CÓDIGO	DESCRIPCIÓN	PRECIO	INNER	MASTER
V3026	Agua fría	\$ 50.00	1	300

**Cartucho**

Cuerpo de latón

De compresión

Para mezcladoras:  
MEZRT1812  
MEZRT1811



CÓDIGO	DESCRIPCIÓN	PRECIO	INNER	MASTER
V3027	Agua fría	\$ 160.00	1	100

**Cartucho**

Cuerpo de latón

De compresión

Para regadera tina lateral:  
MEZR1801  
MEZR1802  
MEZRT1811  
MEZRT1812

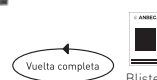

CÓDIGO	DESCRIPCIÓN	PRECIO	INNER	MASTER
V3028	Agua fría	\$ 150.00	1	100

**Cartucho**

Cuerpo de latón

De compresión

Para mezcladora cuerda fina 3/4"

Cartucho compatible con las marcas de más presencia en el mercado

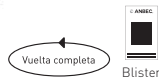

CÓDIGO	DESCRIPCIÓN	PRECIO	INNER	MASTER
VRC01	Agua fría	\$ 67.00	1	200

**Cartucho**

Cuerpo de latón

De compresión

Para llave de empotrar mediano cuerda estandar 3/4"

Cartucho compatible con las marcas de más presencia en el mercado



CÓDIGO	DESCRIPCIÓN	PRECIO	INNER	MASTER
VRC02	Agua fría	\$ 70.00	1	200

**Cartucho**

Cuerpo de latón

Universal largo

De compresión

Cartucho compatible con las marcas de más presencia en el mercado



CÓDIGO	DESCRIPCIÓN	PRECIO	INNER	MASTER
VRC03	Agua fría	\$ 135.00	1	100

**Cartucho**

Cuerpo de latón

Cerámico

Para mezcladoras:  
MEZTS6027  
MEZTS6012  
MEZTS6012S  
MEZTS6018BN  
MEZTS6018C  
MEZTS6018CG  
MEZTS6059BN  
MEZTS6059C



CÓDIGO	DESCRIPCIÓN	PRECIO	INNER	MASTER
V3029	Agua fría	\$ 76.00	1	250
V3029R	Agua caliente	\$ 76.00	1	250

**Cartucho**

Cuerpo de latón

Cerámico

Para mezcladoras:  
MEZB107KCP2  
MEZB1080  
MEZB4096  
MEZF8047  
MEZF8055  
MEZF8080  
MEZF8088  
MEZL1806



CÓDIGO	DESCRIPCIÓN	PRECIO	INNER	MASTER
V3031	Agua fría	\$ 56.00	1	200
V3031R	Agua caliente	\$ 56.00	1	200

**Cartucho**

Cuerpo de latón

Cerámico

Para mezcladoras:  
MEZTS6018BN  
MEZTS6018C  
MEZTS6018CG  
MEZTS6012  
MEZTS6059C  
MEZTS6059BN  
MEZTS6012S



CÓDIGO	DESCRIPCIÓN	PRECIO	INNER	MASTER
V3032	Agua fría	\$ 60.00	1	200
V3032R	Agua caliente	\$ 60.00	1	200

## Cartucho

Cuerpo de latón

Cerámico

Para mezcladoras:  
MEZL8040



## Cartucho

Cuerpo de latón

Cerámico

Para mezcladoras:  
MEZB107  
MEZF151L  
MEZF151KCP2  
MEZF8008L  
MEZF991  
MEZF1643  
MEZB469  
MEZB8025BN  
MEZF1758  
MEZF473



## Cartucho

Cuerpo de latón

Cerámico

Para mezcladoras:  
MEZL8030  
MEZL4203  
MEZL8030BN



CÓDIGO	DESCRIPCIÓN	PRECIO	INNER	MASTER
V3033	Agua fría	\$ 60.00	1	200
V3033R	Agua caliente	\$ 60.00	1	200



CÓDIGO	DESCRIPCIÓN	PRECIO	INNER	MASTER
V3034	Agua fría	\$ 55.00	1	250
V3034R	Agua caliente	\$ 55.00	1	250



CÓDIGO	DESCRIPCIÓN	PRECIO	INNER	MASTER
V3036	Agua fría	\$ 56.00	1	200
V3036R	Agua caliente	\$ 56.00	1	200

## Cartucho

Cuerpo de latón

Cerámico

Para mezcladoras:  
MEZL4202  
MEZL4202KCP2  
MEZB4065C



## Cartucho

Cuerpo de latón

Cerámico

Para mezcladora:  
MEZF8060  
MEZTS6012



## Cartucho

Cuerpo de latón

Cerámico

Para mezcladora:  
MEZTS122



CÓDIGO	DESCRIPCIÓN	PRECIO	INNER	MASTER
V3037	Agua fría	\$ 56.00	1	250
V3037R	Agua caliente	\$ 56.00	1	250



CÓDIGO	DESCRIPCIÓN	PRECIO	INNER	MASTER
V3038	Agua fría	\$ 68.00	1	250
V3038R	Agua caliente	\$ 68.00	1	250

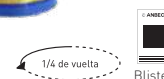

CÓDIGO	DESCRIPCIÓN	PRECIO	INNER	MASTER
V3039	Agua fría	\$ 73.00	1	250
V3039R	Agua caliente	\$ 73.00	1	250

## Cartucho

Cuerpo de latón

Cerámico

Para mezcladora:  
MEZF8055  
MEZF8088  
MEZF8051  
MEZB1645  
MEZL791C  
MEZL791BN  
MEZB1759  
MEZB8029  
MEZB1646  
MEZF8064



## Cartucho

Cuerpo de latón

Cerámico

Para mezcladora:  
MEZR2001  
MEZR2002  
MEZR8236BN  
MEZR8236C  
MEZR8237BN  
MEZR8237C



## Cartucho

Cuerpo de latón

Cerámico

Para mezcladora:  
MEZTY842WK  
MEZB1090  
MEZB4003  
MEZB4140  
MEZB8020  
MEZF8010  
MEZF8015  
MEZF8033  
MEZF8041BN  
MEZF8050  
MEZF8090  
MEZF8204  
MEZL0404CBH6  
MEZL105PP  
MEZL4010  
MEZL4033  
MEZL4077  
MEZL696  
MEZL8027

MEZL8041  
MEZL8041BN  
MEZL8041CD  
MEZL8042  
MEZTY846



CÓDIGO	DESCRIPCIÓN	PRECIO	INNER	MASTER
V3041	Agua fría	\$ 53.00	1	200
V3041R	Agua caliente	\$ 53.00	1	200



CÓDIGO	DESCRIPCIÓN	PRECIO	INNER	MASTER
V3043	Agua fría	\$ 84.00	1	250
V3043R	Agua caliente	\$ 84.00	1	250



CÓDIGO	DESCRIPCIÓN	PRECIO	INNER	MASTER
V3045	Agua fría	\$ 56.00	1	200
V3045R	Agua caliente	\$ 56.00	1	200

**Cartucho**

Cuerpo de ABS

Cerámico

Para mezcladora:  
 MEZ0403CBH8 MEZL8028C  
 MEZB1090 MEZTY842WCC1  
 MEZB4003 MEZTY846  
 MEZB8020 MEZTY847CK  
 MEZF8005 MEZTY848CK  
 MEZF8010  
 MEZF8015  
 MEZF8033  
 MEZF8041BN  
 MEZF8050  
 MEZF8090  
 MEZF8204  
 MEZL0404CBH6  
 MEZL105PP  
 MEZL4009  
 MEZL4010  
 MEZL4033  
 MEZL4077  
 MEZL8027

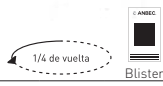

CÓDIGO	DESCRIPCIÓN	PRECIO	INNER	MASTER
V3046	Agua fría	\$ 23.50	1	200
V3046R	Agua caliente	\$ 23.50	1	200

**Cartucho**

Cuerpo de latón

Cerámico

Para mezcladora:  
 MEZL8045

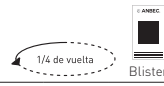

CÓDIGO	DESCRIPCIÓN	PRECIO	INNER	MASTER
V3047	Agua fría	\$ 48.00	1	200
V3047R	Agua caliente	\$ 48.00	1	200

**Cartucho**

Cuerpo de latón

Cerámico

Para mezcladoras:  
 MEZTS456C  
 MEZTS456BN  
 MEZTS6012  
 MEZTS6012S  
 MEZTS6018BN  
 MEZTS6018C  
 MEZTS6018CG  
 MEZTS6059BN  
 MEZTS6059C



CÓDIGO	DESCRIPCIÓN	PRECIO	INNER	MASTER
V3048	Agua fría	\$ 62.00	1	200
V3048R	Agua caliente	\$ 62.00	1	200

**Cartucho**

Cuerpo de latón

Cerámico

Para mezcladora:  
 JESM  
 JERM



CÓDIGO	DESCRIPCIÓN	PRECIO	INNER	MASTER
V3050	Agua fría	\$ 50.00	1	200
V3050R	Agua caliente	\$ 50.00	1	200

**Cartucho**

Cuerpo de latón

Cerámico

Cartucho compatible con las marcas de más presencia en el mercado



CÓDIGO	DESCRIPCIÓN	PRECIO	INNER	MASTER
V3051	Agua fría	\$ 55.00	1	250
V3051R	Agua caliente	\$ 55.00	1	250

**Cartucho**

Cuerpo de latón

Cerámico

Cartucho compatible con las marcas de más presencia en el mercado



CÓDIGO	DESCRIPCIÓN	PRECIO	INNER	MASTER
V3054	Agua fría	\$ 84.00	1	100
V3054R	Agua caliente	\$ 84.00	1	100

**Cartucho**

Cuerpo de latón

De compresión

Para mezcladora:  
 MEZL4084



CÓDIGO	DESCRIPCIÓN	PRECIO	INNER	MASTER
V3055	Agua fría	\$ 58.00	1	200

**Cartucho**

Cuerpo de latón

Cerámico

Para mezcladora:  
 MEZL4209



CÓDIGO	DESCRIPCIÓN	PRECIO	INNER	MASTER
V3056	Agua fría	\$ 50.00	1	200
V3056R	Agua caliente	\$ 50.00	1	200

**Cartucho**

Cuerpo de latón

Cerámico

Para mezcladoras:  
 MEZF8081C  
 MEZF8081BN



CÓDIGO	DESCRIPCIÓN	PRECIO	INNER	MASTER
V3057	Agua fría	\$ 100.00	1	200
V3057R	Agua caliente	\$ 100.00	1	200

## Cartucho

Cuerpo de latón

De compresión  
Para mezcladoras:  
MEZF152  
MEZF8009  
MEZF8070



CÓDIGO	DESCRIPCIÓN	PRECIO	INNER	MASTER
V3058	Agua fría	\$ 58.00	1	200

## Cartucho

Cuerpo de latón

Cerámico  
Cartucho compatible con las marcas de más presencia en el mercado



CÓDIGO	DESCRIPCIÓN	PRECIO	INNER	MASTER
V3059	Agua fría	\$ 59.00	1	200
V3059R	Agua caliente	\$ 59.00	1	200

## Cartucho

Cuerpo de ABS

Cerámico  
Para mezcladoras:  
MEZL135C  
MEZL136BN



CÓDIGO	DESCRIPCIÓN	PRECIO	INNER	MASTER
V3060	Agua fría	\$ 95.00	1	200

## Cartucho

Cuerpo de latón

Cerámico  
Para mezcladora:  
MEZTS6018G



CÓDIGO	DESCRIPCIÓN	PRECIO	INNER	MASTER
V3061	Agua fría	\$ 60.00	1	200
V3061R	Agua caliente	\$ 60.00	1	200

## Cartucho

Cuerpo de latón

Cerámico  
Para mezcladoras:  
MEZB993  
MEZF473  
MEZF151L  
MEZF8008L



CÓDIGO	DESCRIPCIÓN	PRECIO	INNER	MASTER
V3063	Agua fría	\$ 52.00	1	240
V3063R	Agua caliente	\$ 52.00	1	240

## Cartucho

Cuerpo de latón

Cerámico  
Para mezcladora:  
MEZB470

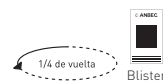

CÓDIGO	DESCRIPCIÓN	PRECIO	INNER	MASTER
V3064	Agua fría	\$ 50.00	1	240
V3064R	Agua caliente	\$ 50.00	1	240

## Cartucho

Cuerpo de latón

De compresión  
Para mezcladora:  
MEZF472

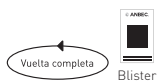

CÓDIGO	DESC.	PRECIO	INN.	MAS.
V3065	Agua fría	\$ 53.00	1	240

## Cartucho

Cuerpo de latón

De compresión  
Para mezcladora:  
MEZL794C

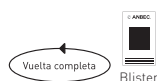

CÓDIGO	DESC.	PRECIO	INN.	MAS.
V3067	Agua fría	\$ 74.00	1	300

## Cartucho

Cuerpo de latón

De compresión  
Para juego de empotrar PP-R de termofusión:  
JPPR892



CÓDIGO	DESC.	PRECIO	INN.	MAS.
VPPR1043	Agua fría	\$ 70.00	1	240

## Cartucho

Cuerpo de latón

De compresión  
Para mezcladoras:  
MEZF8044  
MEZF471



CÓDIGO	DESC.	PRECIO	INN.	MAS.
V3062	Agua fría	\$ 50.00	1	240

**Empaque transparente para desagüe o trampa (bolsa con 50 piezas)**



CÓDIGO	DESCRIPCIÓN	PRECIO	INNER	MASTER
EMPT706	1 1/2"	\$ 80.00	1	100
EMPT707	1 1/4"	\$ 77.00	1	100

**Empaque para conexión hembra 1/2" (bolsa con 100 piezas)**



CÓDIGO	PRECIO	INNER	MASTER
ENP716	\$ 167.00	1	500

**Empaque de neopreno plano para manguera de jardín 3/4" (bolsa con 100 piezas)**



CÓDIGO	PRECIO	INNER	MASTER
ENP764	\$ 110.00	1	500

**Empaque o-ring (bolsa 100 piezas)**



CÓDIGO	DESCRIPCIÓN	PRECIO	INNER	MASTER
EMPO58	5/8"	\$ 67.00	1	200
EMPO1116	1 1/16"	\$ 67.00	1	200
EMPO38	3/8"	\$ 67.00	1	200
EMPO12	1/2"	\$ 67.00	1	200
EMPO716	7/16"	\$ 67.00	1	200
EMPO916	9/16"	\$ 67.00	1	100

**Juego de empaques y tuercas para mezcladora**



CÓDIGO	PRECIO	INNER	MASTER
JUEETM	\$ 15.00	1	200

**Empaque con resorte (juego)**



CÓDIGO	PRECIO	INNER	MASTER
EMPR	\$ 15.00	1	5,000

**Empaque o-ring (bolsa 100 piezas)**



CÓDIGO	Ø INT.	Ø EXT.	PRECIO	INN.	MAS.
EMPO1319	13/16"	11/16"	\$ 110.00	1	100
EMPO1320	11/16"	7/8"	\$ 70.00	1	100
EMPO1321	5/8"	3/4"	\$ 70.00	1	200
EMPO1322	7/16"	5/8"	\$ 60.00	1	100
EMPO1323	5/16"	7/16"	\$ 60.00	1	100
EMPO1324	3/16"	5/16"	\$ 60.00	1	100
EMPO1325	3/4"	1"	\$ 110.00	1	100
EMPO1326	5/8"	13/16"	\$ 70.00	1	100
EMPO1327	9/16"	3/4"	\$ 60.00	1	100
EMPO1328	3/8"	9/16"	\$ 60.00	1	100
EMPO1329	1/4"	3/8"	\$ 60.00	1	100
EMPO1330	5/32"	9/32"	\$ 60.00	1	100
EMPO1331	3/4"	15/16"	\$ 70.00	1	200
EMPO1332	1/2"	11/16"	\$ 60.00	1	100
EMPO1333	1/2"	5/8"	\$ 60.00	1	100
EMPO1334	3/8"	1/2"	\$ 60.00	1	100
EMPO1335	7/32"	11/32"	\$ 60.00	1	100
EMPO1336	1/8"	1/4"	\$ 60.00	1	100

**Empaque de neopreno cónico (bolsa 100 piezas)**



CÓDIGO	DESCRIPCIÓN	PRECIO	INNER	MASTER
ENC0	0	\$ 75.00	1	100
ENC00	00	\$ 75.00	1	100
ENC14	1/4"	\$ 80.00	1	100
ENC14L	1/4" L	\$ 80.00	1	100
ENC38	3/8"	\$ 80.00	1	50
ENC38L	3/8" L	\$ 80.00	1	100
ENC12	1/2"	\$ 110.00	1	100
ENC12L	1/2" L	\$ 110.00	1	100
ENC38M	3/8" M	\$ 80.00	1	50

**Caja de empaques de neopreno cónico con 200 piezas**

Contiene empaques de las siguientes medidas:

- 0
- 001/4" S
- 1/4" L
- 1/4"
- 3/8"
- 3/8" L
- 3/8" M



CÓDIGO	PRECIO	INNER
CENC711	\$ 270.00	1

**Empaque de neopreno plano (bolsa 100 piezas)**



CÓDIGO	DESCRIPCIÓN	PRECIO	INNER	MASTER
ENP0	0	\$ 80.00	1	100
ENP00	00	\$ 80.00	1	100
ENP14	1/4"	\$ 80.00	1	100
ENP14L	1/4" L	\$ 80.00	1	100
ENP38	3/8"	\$ 80.00	1	100
ENP38L	3/8" L	\$ 80.00	1	100
ENP12	1/2"	\$ 105.00	1	100
ENP12L	1/2" L	\$ 105.00	1	100
ENP38M	3/8" M	\$ 80.00	1	100

**Caja de empaques de neopreno plano con 200 piezas**

Contiene empaques de las siguientes medidas:

- 0
- 001/4" S
- 1/4" L
- 1/4"
- 3/8"
- 3/8" L
- 3/8" M



CÓDIGO	PRECIO	INNER
CENP710	\$ 315.00	1

El aspecto, empaque, inner o master de los productos puede variar sin previo aviso debido a la innovación continua de nuestras marcas.



## Alimentador flexible para lavabo/fregadero 1/2" x 1/2"

Temperatura de trabajo:  
23° C - 90° C

Presión de trabajo:  
10 kg/cm<sup>2</sup> (100 psi)

Tramado en aluminio

Conexiones de latón

Inserto de latón

Cuerpo de EPDM

Férula metálica



Bolsa con 10 piezas

CÓDIGO	DESCRIPCIÓN	PRECIO UNITARIO	INNER	MASTER
ALIM40MA	40 cm	\$ 23.00	10	200
ALIM55MA	55 cm	\$ 25.00	10	200
ALIM1MA	100 cm	\$ 42.00	10	100

## Alimentador flexible para sanitario 1/2" x 7/8"

Temperatura de trabajo:  
23° C - 90° C

Presión de trabajo:  
10 kg/cm<sup>2</sup> (100 psi)

Tramado en aluminio

Conexiones de latón

Inserto de latón

Cuerpo de EPDM

Férula metálica



Bolsa con 10 piezas

CÓDIGO	DESCRIPCIÓN	PRECIO UNITARIO	INNER	MASTER
ALISM40	40 cm	\$ 26.00	10	200
ALISM55	55 cm	\$ 29.00	10	200

## Alimentador flexible para lavabo/fregadero 1/2" x 1/2"

Temperatura de trabajo:  
23° C - 100° C

Presión de trabajo:  
7 kg/cm<sup>2</sup> (99 psi)

Tramado en hule reforzado

Conexiones de latón

Inserto de latón

Cuerpo de EPDM

Férula metálica



Bolsa con 10 piezas

CÓDIGO	DESCRIPCIÓN	PRECIO UNITARIO	INNER	MASTER
ALIL214	1/2" x 1/2" 55 cm	\$ 26.00	10	200
ALIL213	1/2" x 1/2" 40 cm	\$ 25.00	10	200

## Alimentador flexible para sanitario 1/2" x 7/8"

Tuerca metálica

Temperatura de trabajo:  
0° C - 65° C

Presión de trabajo:  
8.8 kg/cm<sup>2</sup> (125 psi)

Tramado de hule

Espiga de latón

Cuerpo de EPDM

Férula de latón niquelado

Empaque cónico de hule



Bolsa con 10 piezas

CÓDIGO	DESCRIPCIÓN	PRECIO UNITARIO	INNER	MASTER
ALIS216	1/2" x 7/8" 55 cm	\$ 36.00	10	200
ALIS215	1/2" x 7/8" 40 cm	\$ 32.00	10	200

## Alimentador flexible para lavabo/fregadero 1/2" x 1/2"

Temperatura de trabajo:  
23° C - 100° C

Presión de trabajo:  
8 kg/cm<sup>2</sup> (113 psi)

Tramado en vinilo reforzado

Conexiones de plástico

Inserto de latón

Cuerpo de EPDM

Férula metálica



Bolsa con 10 piezas

CÓDIGO	DESCRIPCIÓN	PRECIO UNITARIO	INNER	MASTER
ALILV40	40 cm	\$ 28.00	10	200
ALILV55	55 cm	\$ 32.00	10	200

## Alimentador flexible para sanitario 1/2" x 7/8"

Temperatura de trabajo:  
23° C - 100° C

Presión de trabajo:  
8 kg/cm<sup>2</sup> (113 psi)

Tramado en vinilo reforzado

Conexiones de plástico

Inserto de latón

Cuerpo de EPDM

Férula metálica



Bolsa con 10 piezas

CÓDIGO	DESCRIPCIÓN	PRECIO UNITARIO	INNER	MASTER
ALISV40	40 cm	\$ 28.00	10	200
ALISV55	55 cm	\$ 31.00	10	200

## Alimentador para lavabo "T" 1/2"

Temperatura de trabajo:  
0° C - 80° C

Presión de trabajo:  
10 kg/cm<sup>2</sup> (100 psi)

Tramado en aluminio

Conexiones metálicas

Inserto de latón

Cuerpo de EPDM

Férula metálica



CÓDIGO	DESCRIPCIÓN	PRECIO	INNER	MASTER
ALILTM	20 x 20 x 40 cm	\$ 95.00	1	100



**Alimentador flexible para boiler 60 cm**

Temperatura de trabajo:  
0° C - 80° C

Presión de trabajo:  
10 kg/cm<sup>2</sup> (100 psi)

Tramado en acero inoxidable

Inserto de latón

Cuerpo de EPDM

Férula de acero inoxidable

Conexiones de latón



CÓDIGO	DESCRIPCIÓN	PRECIO	INNER	MASTER
MBA1212	1/2" x 1/2"	\$ 100.00	5	50
MBA3412	3/4" x 1/2"	\$ 105.00	10	50
MBA3434	3/4" x 3/4"	\$ 112.00	10	50

**Alimentador flexible para boiler 80 cm**

Temperatura de trabajo:  
0° C - 80° C

Presión de trabajo:  
10 kg/cm<sup>2</sup> (100 psi)

Tramado en acero inoxidable

Inserto de latón

Cuerpo de EPDM

Férula de acero inoxidable

Conexiones de latón



CÓDIGO	DESCRIPCIÓN	PRECIO	INNER	MASTER
MBA666	1/2" x 1/2"	\$ 110.00	10	50
MBA667	3/4" x 1/2"	\$ 125.00	10	50
MBA668	3/4" x 3/4"	\$ 136.00	10	50

**Alimentador flexible para boiler  
1/2" hembra, 3/4" macho**

Temperatura de trabajo:  
0° C - 80° C

Presión de trabajo:  
10 kg/cm<sup>2</sup> (100 psi)

Tramado en acero  
inoxidable

Espiga de latón

Cuerpo de hule EPDM

Férula de latón  
niquelado

Conexiones de latón



CÓDIGO	DESCRIPCIÓN	PRECIO	INNER	MASTER
MBA671	60 cm	\$ 110.00	10	50
MBA672	80 cm	\$ 150.00	10	50

**Conector para lavadora 3/4" x 3/4" x 120 cm**

Temperatura de trabajo:  
0° C - 60° C

Presión de trabajo:  
7 kg/cm<sup>2</sup> (99 psi)

Manguera de PVC

Con tuerca metálica

Inserto de latón



CÓDIGO	PRECIO	INNER	MASTER
CL34	\$ 90.00	1	40

**Conector "y" para lavadora 3/4" x 3/4" x 3/4" x 30 cm**

Temperatura de trabajo:  
0° C - 60° C

Presión de trabajo:  
7 kg/cm<sup>2</sup> (99 psi)

Manguera de PVC

Con tuerca metálica

Inserto de latón



CÓDIGO	PRECIO	INNER	MASTER
CYL34	\$ 110.00	1	50

**Manguera de desagüe 1.8 m**

Para lavadora

Universal

Cuerpo de PVC



CÓDIGO	PRECIO	INNER	MASTER
MANL217	\$ 136.00	1	20

El aspecto, empaque, inner o master de los productos puede variar sin previo aviso debido a la innovación continua de nuestras marcas.

Regulador con manguera

Producto NUEVO



Producto sujeto a disponibilidad\*



CÓDIGO	DESCRIPCIÓN
ABRM1411	60 cm

Pigtail para gas con maneral trenzado 7/16" x 7/8" x 55 cm aluminio

Temperatura de trabajo: 60° C  
Presión de trabajo: 17.5 kg/cm<sup>2</sup> (250 psi)  
Manguera de nitrilo  
Trenzado de aluminio



CÓDIGO	PRECIO	INNER	MASTER
PGAL	\$ 70.00	10	100

Pigtail para gas con maneral trenzado 7/16" x 7/8" x 55 cm acero inoxidable

Temperatura de trabajo: 60° C  
Presión de trabajo: 17.5 kg/cm<sup>2</sup> (250 psi)  
Manguera de nitrilo  
Trenzado de acero inoxidable



CÓDIGO	PRECIO	INNER	MASTER
PIGMA	\$ 80.00	1	100

Pigtail flexible para gas de nylon con maneral 7/16" x 7/8" x 55 cm

Temperatura de trabajo: 60° C  
Presión de trabajo: 17.5 kg/cm<sup>2</sup> (250 psi)  
Férula de acero inoxidable  
Manguera de doble capa PVC/vinilo  
Trenzado de polietileno



CÓDIGO	PRECIO	INNER	MASTER
PIGN1406	\$ 90.00	10	100

Alimentador flexible para gas 3/8" x 3/8"

Manguera: Doble capa PVC/vinilo  
Presión de trabajo 21 kg/cm<sup>2</sup>(300 psi)  
Trenzado de nylon  
Tuerca de latón  
Espiga de latón  
Férula de latón  
Temperatura de trabajo: 60° C



CÓDIGO	DESCRIPCIÓN	PRECIO	INNER	MASTER
AGTN1399	60 cm	\$ 55.00	1	100
AGTN1400	1 m	\$ 64.00	1	100
AGTN1401	1.5 m	\$ 78.00	1	80
AGTN1402	2 m	\$ 99.00	1	50
AGTN1403	3 m	\$ 140.00	1	30
AGTN1404	4 m	\$ 170.00	1	40
AGTN1405	5 m	\$ 205.00	1	30

Alimentador flexible para gas 3/8" x 3/8"

Conexiones de latón  
Cuerpo de PVC  
Inserto de latón  
Trenzado de aluminio  
Manguera de nitrilo  
Presión máxima de trabajo: 7 kg/cm<sup>2</sup> (99 psi)  
Temperatura de trabajo: 60° C



CÓDIGO	DESCRIPCIÓN	PRECIO	INNER	MASTER
AGAL60	60 cm	\$ 53.00	1	200
AGAL1	1 m	\$ 60.00	1	100
AGAL15	1.5 m	\$ 66.00	1	100
AGAL2	2 m	\$ 74.00	1	50
AGAL3	3 m	\$ 96.00	1	50
AGAL4	4 m	\$ 117.00	1	25
AGAL5	5 m	\$ 134.00	1	25

Manguera para gas natural 1/2" NPT x 1/2" flare

Conector de gas en acero inoxidable para uso interior y exterior  
Este producto soporta temperaturas ambientales extremas  
Durabilidad: 10 años  
Temperatura de trabajo: 60° C  
Presión máxima de trabajo: 17.5 Kg/cm<sup>2</sup> (250 psi)



CÓDIGO	DESCRIPCIÓN	PRECIO	INNER	MASTER
MANGN12	12"	\$ 155.00	10	100
MANGN18	18"	\$ 175.00	10	100
MANGN24	24"	\$ 225.00	10	100
MANGN30	30"	\$ 260.00	10	100
MANGN36	36"	\$ 285.00	10	100
MANGN48	48"	\$ 330.00	10	100

El aspecto, empaque, inner o master de los productos puede variar sin previo aviso debido a la innovación continua de nuestras marcas.

**Kit de instalación para mezcladora de lavabo**

**Incluye:**

1 TL1085 Césped para lavabo 1 1/4" con contra lavabo rígida PVC

2 ALIM40MA Alimentador lavabo/fregador aluminio 1/2" x 1/2" 40 cm

2 LLARAVCR Llave de retención 1/2" x 1/2"

1 CT12260 Cinta selladora con PTFE 1/2" x 260" (6.60 m)

1 CONC114 Conector céspol lavabo 2" x 1 1/4"



CÓDIGO	PRECIO	INNER	MASTER
KIT1	\$ 211.00	1	20

**Mezcladora de lavabo con kit de instalación**

**Incluye:**

1 MEZL4009 Mezcladora lavabo con cubierta y manerales ABS, cromada.

2 ALIM40MA alimentador lavabo/fregador aluminio 1/2" x 1/2" 40 cm

2 LLARAVCR Llave de retención 1/2" x 1/2"

1 TL1085 Césped para lavabo 1 1/4" con contra lavabo rígida PVC

1 CT12260 Cinta selladora con PTFE 1/2" x 260" (6.60 m)

1 CONC114 Conector céspol lavabo 2" x 1/14"



CÓDIGO	PRECIO	INNER	MASTER
KIT2	\$ 504.00	1	20

**Kit de instalación para sanitario con cuello de cera**

**Incluye:**

1 LLARAVCR Llave de retención 1/2" x 1/2"

1 ALISM40 Alimentador para sanitario aluminio 1/2" x 7/8" 40 cm

1 CUECCG Cuello de cera con guía

1 PIJS Juego de pijas 3 1/2"

1 CT12260 Cinta selladora con PTFE 1/2" x 260" (6.60 m)



CÓDIGO	PRECIO	INNER	MASTER
KIT3	\$ 116.00	1	20

**Kit de instalación para sanitario con cuello**

**Incluye:**

1 LLARAVCR Llave de retención 1/2" x 1/2"

1 ALISM40 Alimentador para sanitario aluminio 1/2" x 7/8" 40 cm

1 BS1025 Cuello para sanitario

1 CT12260 Cinta selladora con PTFE 1/2" x 260" (6.60 m)



CÓDIGO	PRECIO	INNER	MASTER
KIT4	\$ 162.00	1	20

**Kit de instalación para tarja doble con mezcladora**

**Incluye:**

1 MEZF8012 Mezcladora fregador cubierta y manerales ABS, vuelta completa.

2 ALIM55MA Alimentador lavabo/fregador aluminio 1/2" x 1/2" 55 cm

2 LLARAVCR Llave de retención 1/2" x 1/2"

1 DD1030 Césped doble para fregador de 1/2"

2 CONCPVC Contraacnasta para fregador de 3 1/2"

1 CONC112 Conector céspol fregador 2" x 1 1/2"

1 CT12260 Cinta selladora con PTFE 1/2" x 260" (6.60 m)



CÓDIGO	PRECIO	INNER	MASTER
KIT5	\$ 638.00	1	20

**Kit de instalación para tarja doble**

**Incluye:**

1 CT12260 Cinta selladora con PTFE 1/2" x 260" (6.60 m)

2 ALIM55MA Alimentador lavabo/fregador aluminio 1/2" x 1/2" 55 cm

2 LLARAVCR Llave de retención 1/2" x 1/2"

1 DD1030 Césped doble para fregador de 1/2"

1 CONCPVC Contraacnasta para fregador de 3 1/2"

1 CONC112 Conector céspol fregador 2" x 1 1/2"



CÓDIGO	PRECIO	INNER	MASTER
KIT6	\$ 318.00	1	20

El aspecto, empaque, inner o master de los productos puede variar sin previo aviso debido a la innovación continua de nuestras marcas.

### Kit de instalación para tarja de una tina

**Incluye:**

2 LLARAVCR Llave de retención 1/2" x 1/2"

2 ALIM55MA Alimentador lavabo/fregador aluminio 1/2" x 1/2" 55 cm

1 TLF1099 Césped para lavabo de 1 1/4"

1 CONCPVCT Contracanal para fregador de 3 1/2"

1 CT12260 Cinta selladora con PTFE 1/2" x 260" (6.60 m)

1 CONC112 Conector céspol fregador 2" x 1 1/2"



CÓDIGO	PRECIO	INNER	MASTER
KIT7	\$ 245.00	1	20

### Kit de instalación para boiler de paso

**Incluye:**

2 BKA1410 Alimentador flexible para boiler trenzada aluminio 1/2" x 1/2" x 80 cm

1 AGAL15 Alimentador para gas trenzado aluminio 3/8" x 3/8" x 1.5 m

1 LLAER12 Válvula de esfera roscable

1 LG3812FH Llave para gas 3/8" flare x 1/2" HNPT

1 CT12260 Cinta selladora con PTFE 1/2" x 260" (6.60 m)

1 NIPC3812 Niple campana 3/8" x 1/2"



CÓDIGO	PRECIO	INNER	MASTER
KIT14	\$ 457.00	1	25

### Kit de instalación para tarja de una tina con mezcladora

**Incluye:**

1 BKA412M Mezcladora fregadero cromada cubierta, manerale ABS

2 LLARAVCR Llave de retención 1/2" x 1/2"

2 ALIM55MA Alimentador lav/freg trenzado de aluminio 1/2" x 1/2" x 55 cm

1 TLF1099 Césped para lavabo de 1 1/4"

2 CONCPVCT Contracanal fregador 3 1/2"

1 CT12260 Cinta selladora con PTFE 1/2" x 260" (6.60 m)

1 CONC112 Conector céspol fregador 2" x 1 1/2"



CÓDIGO	PRECIO	INNER	MASTER
KIT10	\$ 527.00	1	20

### Kit de instalación para boiler de paso

**Incluye:**

2 MBA666 Alimentador flexible para boiler 1/2" x 1/2" x 80 cm

1 AGAL15 Alimentador flexible para gas 3/8" x 3/8" x 1.5 m

1 LLAER12 Válvula de esfera roscable 1/2"

1 LG3812FH Llave para gas 3/8" flare x 1/2" HNPT

1 CT12260 Cinta selladora con PTFE 1/2" x 260" (6.60 m)

1 NIPC3812 Niple campana 3/8" x 1/2"



CÓDIGO	PRECIO	INNER	MASTER
KIT15	\$ 457.00	1	25

### Kit de instalación para tarja de una tina con mezcladora

**Incluye:**

1 MEZF8012 Mezcladora fregador cubierta y manerale ABS, vuelta completa.

2 ALIM55MA Alimentador lavabo/fregador aluminio 1/2" x 1/2" 55 cm

2 LLARAVCR Llave de retención 1/2" x 1/2"

1 TLF1099 Césped para lavabo de 1 1/4"

1 CONCPVCT Contracanal para fregador de 3 1/2"

1 CT12260 Cinta selladora con PTFE 1/2" x 260" (6.60 m)

1 CONC112 Conector céspol fregador 2 x 1 1/2"



CÓDIGO	PRECIO	INNER	MASTER
KIT11	\$ 565.00	1	20

**Kit de instalación con tarja y mezcladora**

**Incluye:**

- 1 TIN33196M Tarja doble con herraje 33" x 19" x 6" mate
- 1 BKA1852 Mezcladora fregadero cromada ABS
- 2 CONCPVCT Concracanasta para fregador de 3 1/2"
- 1 DD1040 Céspedol doble para fregador de 1 1/2"
- 1 TFL1099 Céspedol para lavabo de 1 1/4"
- 2 BKA421 Alimentador lavabo/fregador aluminio 40 cm 1/2"
- 1 CT12260 Cinta selladora con PTFE 1/2" x 260" (6.60 m)
- 1 CONC112 Conector céspol fregador 2" x 1 1/2"



**CÓDIGO**  
KIT13

**PRECIO**  
\$ 1,289.00

**INNER**  
1

**Kit de instalación para doble tarja de una tina con mezcladora**

**Incluye:**

- 1 TIN33196M Tarja doble con herraje 33" x 19" x 6" mate
- 1 MEZF8012 Mezcladora fregadero cromada cubierta y manerates de ABS
- 2 LLARAVCR Llave de retención 1/2" x 1/2"
- 2 ALIM55MA Alimentador lav/freg trenzado de aluminio 1/2" x 55 cm
- 1 DD1030 Céspedol doble para fregador de 1/2"
- 2 CONCPVC Concracanasta fregador 3 1/2"
- 1 CT12260 Cinta selladora con PTFE 1/2" x 260" (6.60 m)
- 1 CONC112 Conector céspol fregador 2" x 1 1/2"



**CÓDIGO**  
KIT12

**PRECIO**  
\$ 1,480.00

**INNER**  
1

**Kit de instalación con tarja y mezcladora**

**Incluye:**

- 1 TIN33196B Tarja doble con herraje 33" x 19" x 6" brillante
- 1 MEZF8012 Mezcladora fregadero cromada cubierta y manerates de ABS
- 2 LLARAVCR Llave de retención 1/2" x 1/2"
- 2 ALIM55MA Alimentador lav/freg trenzado de aluminio 1/2" x 55 cm
- 1 DD1030 Céspedol doble para fregador de 1/2"
- 2 CONCPVC Concracanasta fregador 3 1/2"
- 1 CT12260 Cinta selladora con PTFE 1/2" x 260" (6.60 m)
- 1 CONC112 Conector céspol fregador 2" x 1 1/2"



**CÓDIGO**  
KIT9

**PRECIO**  
\$ 1,505.00

**INNER**  
1

El aspecto, empaque, inner o master de los productos puede variar sin previo aviso debido a la innovación continua de nuestras marcas.

**NUEVAS!**



FABRICADAS CON TECNOLOGÍA  
DE CALIDAD BRASILEÑA

# REGADERAS ELÉCTRICAS

## ANRE1942

### MÁS AGUA

Abertura de chorro de hasta 40 cm.

### AHORRO DE ENERGÍA

Hasta **70% de ahorro** en consumo eléctrico en posición tibia.

### BLOQUEO AUTOMÁTICO DE SEGURIDAD

Impide el paso de electricidad durante el cambio de resistencia.

### REGULADOR A DISTANCIA DE TEMPERATURA

Más seguridad al cambiar de temperatura durante su baño.



**4 000 W**  
**127 V~**  
60 Hz / 35 A



## ANRE1943

### AISLADOR ELÉCTRICO

Dispositivo de seguridad que no permite cambiar de temperatura con la ducha abierta, evitando chispas y peligro de choque eléctrico.

### ROCIADOR EN GOMA

Facilita su limpieza por el usuario.



**5 500 W**  
**127 V~**  
60 Hz / 45 A



**GARANTÍA**

**1 AÑO**

**NOM**



Resistencia de fácil reemplazo

TODAS INCLUYEN:

Manguera y  
DESVIADOR DE AGUA  
para ducha manual



**VIDEO DE INSTALACIÓN**  
DISPONIBLE EN NUESTRA APLICACIÓN MÓVIL

**ANBEC**®

## ANRE1941

### AISLADOR ELÉCTRICO

Dispositivo de seguridad que no permite cambiar de temperatura con la ducha abierta, evitando chispas y peligro de choque eléctrico.

### PROLONGADOR PARA DUCHA

Facilita su instalación en la pared.



**5 500 W**  
**127 V~**  
60 Hz / 45 A

basic  
**BitKa**®



LÍNEA DE CONSUMO





## Mezcladora fregadero

Cuerpo de plástico



CÓDIGO	DESCRIPCIÓN	PRECIO	INNER	MASTER
BKA1852	Cromado	\$ 190.00	1	20

## Mezcladora fregadero

Cuerpo metálico



CÓDIGO	DESCRIPCIÓN	PRECIO	INNER	MASTER
BKA412M	Cromado	\$ 240.00	1	20

## Mezcladora fregadero

Cuerpo metálico



CÓDIGO	DESCRIPCIÓN	PRECIO	INNER	MASTER
BKA408M	Cromado	\$ 270.00	1	20

## Mezcladora fregadero

Cuerpo metálico



CÓDIGO	DESCRIPCIÓN	PRECIO	INNER	MASTER
BKA410M	Cromado	\$ 290.00	1	20

## Mezcladora fregadero

Cuerpo metálico

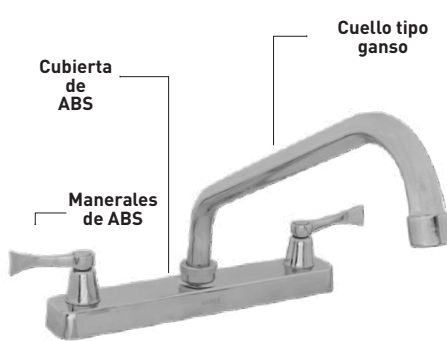

CÓDIGO	DESCRIPCIÓN	PRECIO	INNER	MASTER
BKA409M	Cromado	\$ 300.00	1	20

## Mezcladora fregadero

Cuerpo metálico



CÓDIGO	DESCRIPCIÓN	PRECIO	INNER	MASTER
BKA1889	Cromado	\$ 322.00	1	12

## Mezcladora fregadero

Cuerpo de ABS

Producto NUEVO



CÓDIGO	DESCRIPCIÓN	PRECIO	INNER	MASTER
BKMF1012	Cromado	\$ 206.50	1	20

## Mezcladora fregadero

Cuerpo de ABS

Producto NUEVO



CÓDIGO	DESCRIPCIÓN	PRECIO	INNER	MASTER
BKMF1013	Cromado	\$ 206.50	1	20

## Mezcladora fregadero

Cuerpo metálico



CÓDIGO	DESCRIPCIÓN	PRECIO	INNER	MASTER
BKA411M	Cromado	\$ 290.00	1	20

**Mezcladora fregadero**  
Cuerpo metálico



CÓDIGO	DESCRIPCIÓN	PRECIO	INNER	MASTER
BKA798C	Cromado	\$ 360.00	1	20

**Mezcladora fregadero**  
Cuerpo de plástico



CÓDIGO	DESCRIPCIÓN	PRECIO	INNER	MASTER
BKA1811	Cromado	\$ 310.00	1	20

**Mezcladora fregadero**  
Cuerpo metálico



CÓDIGO	DESCRIPCIÓN	PRECIO	INNER	MASTER
BKA1803	Cromado	\$ 335.00	1	20

**Mezcladora fregadero**  
Cuerpo metálico



CÓDIGO	DESCRIPCIÓN	PRECIO	INNER	MASTER
BKA796C	Cromado	\$ 350.00	1	20

**Mezcladora fregadero**  
Cuerpo metálico



CÓDIGO	DESCRIPCIÓN	PRECIO	INNER	MASTER
BKA698M	Cromado	\$ 355.00	1	20

**Mezcladora fregadero**  
Cuerpo metálico



CÓDIGO	DESCRIPCIÓN	PRECIO	INNER	MASTER
BKA1802	Cromado	\$ 375.00	1	20

**Mezcladora fregadero**  
Cuerpo de ABS

**Producto NUEVO**



CÓDIGO	DESCRIPCIÓN	PRECIO	INNER	MASTER
BKMF1015	Cromado	\$ 236.00	1	32

**Mezcladora fregadero**  
Cuerpo metálico



CÓDIGO	DESCRIPCIÓN	PRECIO	INNER	MASTER
BKA1800	Cromado	\$ 375.00	1	20

**Mezcladora fregadero**  
Cuerpo metálico

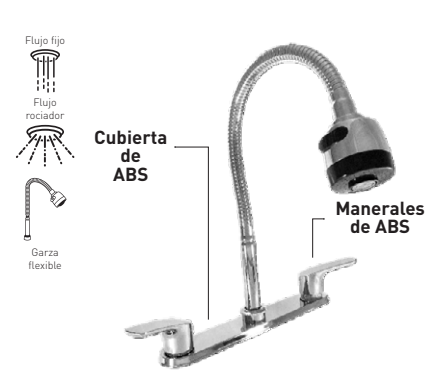

CÓDIGO	DESCRIPCIÓN	PRECIO	INNER	MASTER
BKA1890	Cromado	\$ 385.00	1	12

El aspecto, empaque, inner o master de los productos puede variar sin previo aviso debido a la innovación continua de nuestras marcas.

## Mezcladora fregadero

Cuerpo metálico



CÓDIGO	DESCRIPCIÓN	PRECIO	INNER	MASTER
BKA1801	Cromado	\$ 432.00	1	20

## Mezcladora lavabo

Cuerpo de ABS

Producto **NUEVO**



CÓDIGO	DESCRIPCIÓN	PRECIO	INNER	MASTER
BKML1010	Cromado	\$ 160.50	1	48

## Mezcladora lavabo

Cuerpo de ABS

Producto **NUEVO**



CÓDIGO	DESCRIPCIÓN	PRECIO	INNER	MASTER
BKML1011	Cromado	\$ 164.00	1	48

## Mezcladora lavabo

Cuerpo metálico



CÓDIGO	DESCRIPCIÓN	PRECIO	INNER	MASTER
BKA402M	Cromado	\$ 242.00	1	20

## Mezcladora lavabo

Cuerpo metálico



CÓDIGO	DESCRIPCIÓN	PRECIO	INNER	MASTER
BKA405M	Cromado	\$ 242.00	1	20

## Mezcladora lavabo

Cuerpo metálico



CÓDIGO	DESCRIPCIÓN	PRECIO	INNER	MASTER
BKA406M	Cromado	\$ 242.00	1	20

## Mezcladora lavabo

Cuerpo metálico



CÓDIGO	DESCRIPCIÓN	PRECIO	INNER	MASTER
BKA401M	Cromado	\$ 250.00	1	20

## Mezcladora lavabo

Cuerpo metálico

Producto **NUEVO**



CÓDIGO	DESCRIPCIÓN	PRECIO	INNER	MASTER
BKML1014	Cromado	\$ 300.00	1	20

## Mezcladora lavabo

Tipo bar  
Cuerpo de ABS

Producto **NUEVO**



CÓDIGO	DESCRIPCIÓN	PRECIO	INNER	MASTER
BKMB1008	Cromado	\$ 160.50	1	40

**Mezcladora lavabo**

Tipo bar  
Cuerpo de ABS

Producto **NUEVO**



CÓDIGO	DESCRIPCIÓN	PRECIO	INNER	MASTER
BKMB1009	Cromado	\$ 160.50	1	40

**Mezcladora lavabo**

Tipo bar  
Cuerpo de ABS



CÓDIGO	DESCRIPCIÓN	PRECIO	INNER	MASTER
BKML1928	Cromado	\$ 200.00	1	20

**Mezcladora lavabo**

Tipo bar  
Cuerpo metálico



CÓDIGO	DESCRIPCIÓN	PRECIO	INNER	MASTER
BKA407M	Cromado	\$ 255.00	1	24

**Mezcladora lavabo**

Tipo bar  
Cuerpo de metálico



CÓDIGO	DESCRIPCIÓN	PRECIO	INNER	MASTER
BKA1799	Cromado	\$ 260.00	1	20

**Mezcladora lavabo**

Tipo bar  
Cuerpo metálico



CÓDIGO	DESCRIPCIÓN	PRECIO	INNER	MASTER
BKA797C	Cromado	\$ 270.00	1	15

**Mezcladora lavabo**

Tipo bar  
Cuerpo metálico



CÓDIGO	DESCRIPCIÓN	PRECIO	INNER	MASTER
BKA699M	Cromado	\$ 270.00	1	20

**Mezcladora lavabo**

Cuerpo metálico



CÓDIGO	DESCRIPCIÓN	PRECIO	INNER	MASTER
BKA1804	Cromado	\$ 325.00	1	20

**Mezcladora lavabo**

Cuerpo metálico



CÓDIGO	DESCRIPCIÓN	PRECIO	INNER	MASTER
BKA1805	Cromado	\$ 325.00	1	20

**Mezcladora lavabo**

Cuerpo metálico

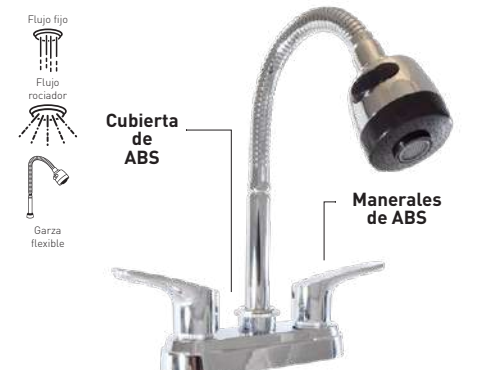

CÓDIGO	DESCRIPCIÓN	PRECIO	INNER	MASTER
BKA1891	Cromado	\$ 345.00	1	20

El aspecto, empaque, inner o master de los productos puede variar sin previo aviso debido a la innovación continua de nuestras marcas.

## Mezcladora monomando lavabo

Cuerpo de ABS

Producto **NUEVO**



Maneral de ABS

Cubierta de ABS



Presión baja



Caja a color

CÓDIGO	DESCRIPCIÓN	PRECIO	INNER	MASTER
BKML1016	Cromado	\$ 295.00	1	28

## Mezcladora monomando lavabo

Cuerpo de ABS

Producto **NUEVO**



Maneral de ABS

Cubierta de ABS



Presión baja



Caja a color

CÓDIGO	DESCRIPCIÓN	PRECIO	INNER	MASTER
BKML1017	Cromado	\$ 426.50	1	20

## Mezcladora monomando lavabo larga

Cuerpo de ABS

Producto **NUEVO**



Maneral de ABS

Cubierta de ABS



Presión baja



Caja a color

CÓDIGO	DESCRIPCIÓN	PRECIO	INNER	MASTER
BKML1018	Cromado	\$ 536.00	1	16

## Garza flexible para lavabo 14"

Cuerpo de ABS



Bolsa Impresa

CÓDIGO	PRECIO	INNER	MASTER
BKA1887	\$ 126.00	1	100

## Garza flexible fregadero 19"

Cuerpo de ABS



Bolsa Impresa

CÓDIGO	PRECIO	INNER	MASTER
BKA1888	\$ 150.00	1	100

## Regadera con brazo y chapetón

Cuerpo de ABS



Brazo de 15 cm



Blister

CÓDIGO	PRECIO	INNER	MASTER
BKRE1001	\$ 100.00	20	100

## Regadera con brazo y chapetón

Cuerpo de ABS



Brazo de 15 cm



Blister

CÓDIGO	PRECIO	INNER	MASTER
BKRE1003	\$ 100.00	20	100

## Regadera con brazo y chapetón

Cuerpo de ABS



Brazo de 15 cm



Blister

CÓDIGO	PRECIO	INNER	MASTER
BKRE1002	\$ 100.00	20	100

**Cartucho para mezcladora(s)**

Para mezcladoras:

- BKA401
- BKA403
- BKA406
- BKA408
- BKA412



CÓDIGO	PRECIO	INNER	MASTER
BKA413	\$ 25.00	1	300

**Cartucho para mezcladora**

Para mezcladora:

- BKA404



CÓDIGO	PRECIO	INNER	MASTER
BKA415	\$ 25.00	1	300

**Cartucho para mezcladora(s)**

Para mezcladoras:

- BKA407
- BKA411



CÓDIGO	PRECIO	INNER	MASTER
BKA416	\$ 25.00	1	300

**Cartucho para mezcladora**

Para mezcladora:

- BKA405M



CÓDIGO	PRECIO	INNER	MASTER
BKA424	\$ 35.00	10	200

**Cartucho para mezcladora**

- BKA407M
- BKA498M



CÓDIGO	PRECIO	INNER	MASTER
BKA425	\$ 35.00	10	200

**Cartucho para mezcladora(s)**

- BKA401M
- BKA402M
- BKA406M



CÓDIGO	PRECIO	INNER	MASTER
BKA426	\$ 35.00	10	200

**Cartucho para mezcladora(s)**

- BKA408M
- BKA412M



CÓDIGO	PRECIO	INNER	MASTER
BKA427	\$ 35.00	10	200

**Cartucho para mezcladora(s)**

- BKA409M
- BKA410M



CÓDIGO	PRECIO	INNER	MASTER
BKA428	\$ 35.00	10	200

**Cartucho para mezcladora**

- BKA796C



CÓDIGO	PRECIO	INNER	MASTER
BKA947	\$ 40.00	10	200

**Cartucho para mezcladora(s)**

- BKA797C
- BKA798C



CÓDIGO	PRECIO	INNER	MASTER
BKA948	\$ 40.00	10	400

El aspecto, empaque, inner o master de los productos puede variar sin previo aviso debido a la innovación continua de nuestras marcas.

## Llave de retención ángulo 1/4" de vuelta 1/2" x 1/2"

Cuerpo metálico  
Peso: 62 g



Producto sujeto a disponibilidad\*



Bolsa Impresa

CÓDIGO	PRECIO	INNER	MASTER
BKA1868	\$ 34.00	32	320

## Llave de jardín 1/2"

Cuerpo metálico  
Peso: 140 g

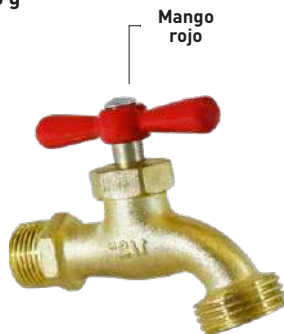

CÓDIGO	PRECIO	INNER	MASTER
BKA423	\$ 37.00	10	100

## Llave de seguridad para exterior para poner candado 1/2"

Cuerpo metálico  
Peso: 100 g



Producto sujeto a disponibilidad\*

Bolsa Impresa

CÓDIGO	PRECIO	INNER	MASTER
BKA1871	\$ 40.00	10	100



## Alimentador flexible para boiler

Trenzado en aluminio

Inserto de latón

Cuerpo de EPDM

Tuercas de acero inoxidable

Temperatura de trabajo: 60 °C

Presión de trabajo: 145 psi



Bolsa con 10 piezas

CÓDIGO	DESC.	CMS	PRECIO UNITARIO	INNER	MAS.
BKA1407	1/2" x 1/2"	60	\$ 62.00	10	100
BKA1408	3/4" x 1/2"	60	\$ 65.00	10	100
BKA1409	3/4" x 3/4"	60	\$ 70.00	6	72
BKA1410	1/2" x 1/2"	80	\$ 75.00	5	100
BKA1411	3/4" x 1/2"	80	\$ 79.00	6	72
BKA1412	3/4" x 3/4"	80	\$ 85.00	6	72

## Alimentador flexible para lavabo/fregador 1/2" x 1/2"

Trenzado en aluminio

Inserto de nylon

Cuerpo de caucho

Tuercas de acero

Temperatura de trabajo: 60 °C

Presión de trabajo: 145 psi



Bolsa con 10 piezas

CÓDIGO	DESCRIPCIÓN	PRECIO UNITARIO	INNER	MASTER
BKA985	40 cm	\$ 15.00	10	200
BKA986	55 cm	\$ 17.00	10	200
BKA1239	100 cm	\$ 28.00	10	100

## Alimentador flexible para sanitario 1/2" x 7/8"

Trenzado en aluminio

Inserto de nylon

Cuerpo de EPDM

Tuercas de plástico

Temperatura de trabajo: 60 °C

Presión de trabajo: 145 psi



Bolsa con 10 piezas

CÓDIGO	DESCRIPCIÓN	PRECIO UNITARIO	INNER	MASTER
BKA419	40 cm	\$ 23.00	10	200
BKA420	55 cm	\$ 25.00	10	200

## Alimentador flexible para lavabo/fregadero 1/2" x 1/2"

Trenzado en aluminio

Inserto de nylon

Cuerpo de EPDM

Tuercas de acero inoxidable

Temperatura de trabajo: 60 °C

Presión de trabajo: 145 psi



Bolsa con 10 piezas

CÓDIGO	DESCRIPCIÓN	PRECIO UNITARIO	INNER	MASTER
BKA421	40 cm	\$ 22.00	10	200
BKA422	55 cm	\$ 24.00	10	200
BKA1240	100 cm	\$ 31.00	10	100

## Alimentador flexible para sanitario 1/2" x 7/8"

Trenzado en aluminio

Inserto de nylon

Cuerpo de caucho

Tuercas de plástico

Temperatura de trabajo: 60 °C

Presión de trabajo: 145 psi



Bolsa con 10 piezas

CÓDIGO	DESCRIPCIÓN	PRECIO UNITARIO	INNER	MASTER
BKA983	35 cm	\$ 19.00	10	200
BKA984	55 cm	\$ 21.00	10	200

**Cerradura pomo**

Tipo esfera

De privacidad



CÓDIGO	DESCRIPCIÓN	PRECIO	INNER	MASTER
BKA1880	Acero	\$ 110.00	6	24

**Cerradura pomo**

Tipo esfera

De privacidad



CÓDIGO	DESCRIPCIÓN	PRECIO	INNER	MASTER
BKA1881	Humo	\$ 110.00	6	24

**Cerradura pomo**

Tipo esfera

De privacidad



CÓDIGO	DESCRIPCIÓN	PRECIO	INNER	MASTER
BKA1882	Dorado	\$ 110.00	6	24

**Cerradura pomo**

Tipo esfera

De seguridad



CÓDIGO	DESCRIPCIÓN	PRECIO	INNER	MASTER
BKA1883	Acero	\$ 118.00	6	24

**Cerradura pomo**

Tipo esfera

De seguridad



CÓDIGO	DESCRIPCIÓN	PRECIO	INNER	MASTER
BKA1884	Humo	\$ 118.00	6	24

**Cerradura pomo**

Tipo esfera

De seguridad



CÓDIGO	DESCRIPCIÓN	PRECIO	INNER	MASTER
BKA1885	Dorado	\$ 118.00	6	24

**Cerradura pomo**

Tipo esfera

De privacidad



CÓDIGO	DESCRIPCIÓN	PRECIO	INNER	MASTER
BKA418SS	Acero	\$ 129.00	6	24

**Cerradura pomo**

Tipo esfera

De privacidad

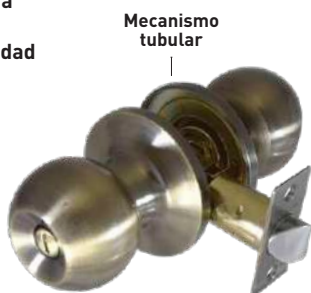

CÓDIGO	DESCRIPCIÓN	PRECIO	INNER	MASTER
BKA418AB	Humo	\$ 129.00	6	24

**Cerradura pomo**

Tipo esfera

De privacidad



CÓDIGO	DESCRIPCIÓN	PRECIO	INNER	MASTER
BKA418PB	Dorado	\$ 129.00	6	24

**Cerradura pomo**

Tipo esfera

De seguridad

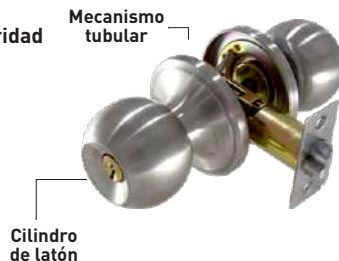

CÓDIGO	DESCRIPCIÓN	PRECIO	INNER	MASTER
BKA417SS	Acero	\$ 132.00	6	24

**Cerradura pomo**

Tipo esfera

De seguridad



CÓDIGO	DESCRIPCIÓN	PRECIO	INNER	MASTER
BKA417AB	Humo	\$ 132.00	6	24

**Cerradura pomo**

Tipo esfera

De seguridad



CÓDIGO	DESCRIPCIÓN	PRECIO	INNER	MASTER
BKA417PB	Dorado	\$ 132.00	6	24

El aspecto, empaque, inner o master de los productos puede variar sin previo aviso debido a la innovación continua de nuestras marcas.



## Cerrojo cilindro / mariposa

Cilindro de latón



## Cerrojo cilindro doble llave

Cilindro de latón



CÓDIGO	DESCRIPCIÓN	PRECIO	INNER	MASTER
BKA973PB	Dorado	\$ 147.00	6	24
BKA973AB	Humo	\$ 147.00	6	24
BKA973SS	Acero	\$ 147.00	6	24

CÓDIGO	DESCRIPCIÓN	PRECIO	INNER	MASTER
BKA972PB	Dorado	\$ 170.00	6	24
BKA972AB	Humo	\$ 170.00	6	24
BKA972SS	Acero	\$ 170.00	6	24

## Combo cerradura pomo, (BKA417) y cerrojo llave / mariposa (BKA973)

Tipo esfera  
De seguridad  
Mecanismo tubular  
Cilindro de latón



## Combo cerradura pomo, (BKA417) y cerrojo llave / llave (BKA972)

Tipo esfera  
De seguridad  
Mecanismo tubular  
Cilindro de latón



CÓDIGO	DESCRIPCIÓN	PRECIO	INNER	MASTER
BKA1860	Dorado	\$ 265.00	6	24
BKA1861	Humo	\$ 265.00	6	24
BKA1862	Acero	\$ 265.00	6	24

CÓDIGO	DESCRIPCIÓN	PRECIO	INNER	MASTER
BKA1863	Dorado	\$ 300.00	6	24
BKA1864	Humo	\$ 300.00	6	24
BKA1865	Acero	\$ 300.00	6	24

## Cerradura manija

De privacidad  
Mecanismo tubular



## Cerradura manija

De seguridad  
Mecanismo tubular  
Cilindro de latón



CÓDIGO	DESCRIPCIÓN	PRECIO	INNER	MASTER
BKA975PB	Dorado	\$ 220.00	6	24
BKA975AB	Humo	\$ 220.00	6	24
BKA975SS	Acero	\$ 220.00	6	24

CÓDIGO	DESCRIPCIÓN	PRECIO	INNER	MASTER
BKA974PB	Dorado	\$ 250.00	6	24
BKA974AB	Humo	\$ 250.00	6	24
BKA974SS	Acero	\$ 250.00	6	24



**IMPERMEABILIZANTES,  
PEGAMENTOS Y CEMENTOS**

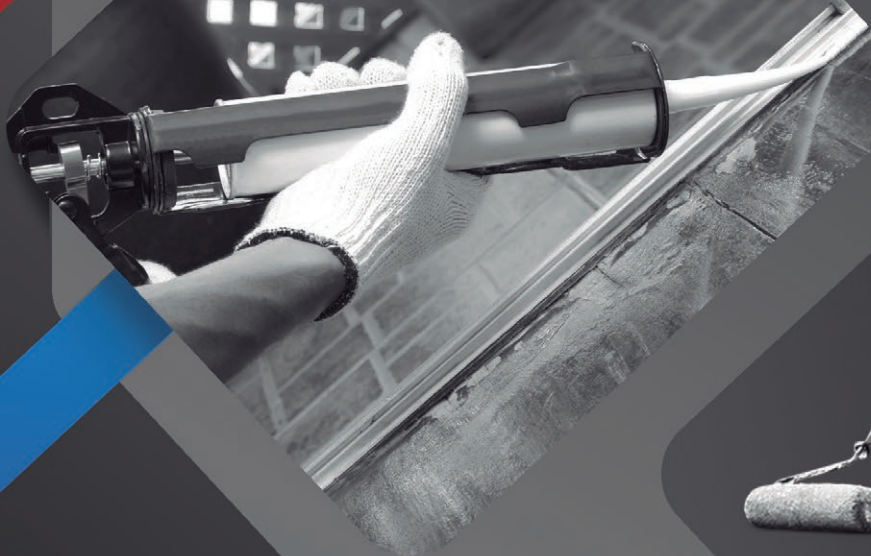

\*Consulte disponibilidad con su agente de ventas.

## Silicón 100%



En condiciones de clima normales

Vida útil  
**50 años**



Aplicación en superficies húmedas

PARA VIDRIO RECUBIERTO Y POLICARBONATO

- Curado rápido
- No corrosivo
- Excelente adherencia
- Compatibilidad con selladores multiusos
- Excelente adhesivo para materiales de construcción
- Excelente resistencia en altas y bajas temperaturas: **-40°C a 150°C**

## Silicón multiusos



En condiciones de clima normales

Vida útil  
**50 años**



Aplicación en superficies húmedas

PARA USO EN EL HOGAR

- Curado rápido
- No corrosivo
- Excelente adherencia
- Compatibilidad con selladores multiusos
- Excelente adhesivo para materiales de construcción
- Excelente resistencia en altas y bajas temperaturas: **-40°C a 150°C**

CÓDIGO	DESCRIPCIÓN	PRECIO	INNER	MASTER
MP0001	Blanco, 300 ml	\$ 79.00	1	24
MP0002	Transparente, 300 ml	\$ 79.00	1	24
MP0010	Transparente, 75 g	\$ 37.00	1	144

CÓDIGO	DESCRIPCIÓN	PRECIO	INNER	MASTER
MP0003	Blanco, 300 ml	\$ 69.00	1	24
MP0004	Transparente, 300 ml	\$ 69.00	1	24
MP0008	Negro, 300 ml	\$ 69.00	1	24

## Sellador acrílico



PINTABLE  
EXCELENTE ADHERENCIA

- Alta flexibilidad
- Gran durabilidad
- Interior y exterior
- Excelente adherencia
- Pintable

## Pegamento clavo líquido



FLEXIBLE Y EXTRA FUERTE

- Alta flexibilidad
- Excelente adherencia
- Anticorrosión
- Anti-desgaste
- Excelente resistencia en altas y bajas temperaturas: **-20°C a +100°C**

CÓDIGO	DESCRIPCIÓN	PRECIO	INNER	MASTER
MP0005	Blanco, 300 ml	\$ 48.00	1	24
MP0006	Hueso, 300 ml	\$ 48.00	1	24

CÓDIGO	DESCRIPCIÓN	PRECIO	INNER	MASTER
MP0007	300 ml	\$ 69.00	1	24
MP0011	75 g	\$ 47.00	1	144

**PVC  
CEMENTO  
PARA USO GENERAL**  
Viscosidad regular - transparente



Para sistemas de tubería sanitaria y aplicaciones DWV



CÓDIGO	DESCRIPCIÓN	PRECIO	INNER	MASTER
PEG112	Tubo 60 ml	\$ 23.00	1	50
PEG113	1/8 de L	\$ 44.00	1	24
PEG114	1/4 de L	\$ 66.00	1	24
PEG115	1/2 de L	\$ 110.00	1	24
PEG116	1 L	\$ 180.00	1	12

**PVC  
CEMENTO  
AZUL REFORZADO**  
Viscosidad media - azul



Para cualquier clima y condiciones de máxima humedad



CÓDIGO	DESCRIPCIÓN	PRECIO	INNER	MASTER
PEG122	Tubo 60 ml	\$ 24.00	1	50
PEG123	1/8 de L	\$ 46.00	1	24
PEG124	1/4 de L	\$ 70.00	1	24
PEG125	1/2 de L	\$ 120.00	1	24
PEG126	1 L	\$ 200.00	1	12

**CPVC  
CEMENTO  
PARA ALTA PRESIÓN**  
Viscosidad media - amarillo



Para uso residencial y comercial para sistemas de agua fría y caliente



CÓDIGO	DESCRIPCIÓN	PRECIO	INNER	MASTER
PEG117	Tubo 60 ml	\$ 28.00	1	50
PEG118	1/8 de L	\$ 55.00	1	24
PEG119	1/4 de L	\$ 84.00	1	24
PEG120	1/2 de L	\$ 145.00	1	24
PEG121	1 L	\$ 270.00	1	12

**PVC  
CEMENTO  
EXTRA REFORZADO**  
Viscosidad gruesa - gris



Para sistemas de agua potable, tuberías de presión y aplicaciones DWV



CÓDIGO	DESCRIPCIÓN	PRECIO	INNER	MASTER
PEG130	1/8 de L	\$ 55.00	1	24
PEG131	1/4 de L	\$ 87.00	1	24
PEG132	1/2 de L	\$ 155.00	1	24

**PVC, CPVC Y ABS  
CEMENTO  
MULTIUSOS**  
Viscosidad alta - transparente



Para sistemas de agua potable, DWV y CONDUIT



CÓDIGO	DESCRIPCIÓN	PRECIO	INNER	MASTER
PEG133	1/8 de L	\$ 55.00	1	24
PEG134	1/4 de L	\$ 100.00	1	24
PEG135	1/2 de L	\$ 170.00	1	24

**PVC, CPVC Y ABS  
CEMENTO  
LIMPIADOR**  
Solvente color púrpura



Ideal para todos los diámetros y superficies



CÓDIGO	DESCRIPCIÓN	PRECIO	INNER	MASTER
LIM127	1/8 de L	\$ 40.00	1	24
LIM128	1/4 de L	\$ 60.00	1	24
LIM129	1/2 de L	\$ 100.00	1	24

**TEFLÓN  
LIQUIDO**  
Color blanco



Para cualquier tipo de tubería roscada, ya sea metálica o de plástico



CÓDIGO	DESCRIPCIÓN	PRECIO	INNER	MASTER
TL136	1/8 de L	\$ 100.00	1	24
TL137	1/4 de L	\$ 180.00	1	24

**CEMENTO  
PLÁSTICO**

- Para sellar, rellenar o resanar grietas
- Excelente adherencia
- Puede ser aplicado verticalmente
- Base agua y libre de solventes dañinos
- Para aplicar en concreto, cemento, materiales pétreos, ladrillo, yeso y estucos



Elongable



Tecnología de cero COV



Aislante térmico



Etiqueta

CÓDIGO	DESCRIPCIÓN	PRECIO	INNER	MASTER
CPLAS1L	1 L	\$ 110.00	1	12
CPLAS4L	4 L	\$ 300.00	1	1

**CONCRETE SEAL**  
Sellador para losas de concreto

- Para sellar, rellenar o resanar grietas
- Sirve como sellador antes de pintar en interiores y exteriores
- Aumenta el desempeño y rendimiento del impermeabilizante **MASTERPROOF.**
- Excelente adherencia en concreto, cemento, piedra y ladrillo
- Inhibe la formación de hongos y bacterias
- Rendimiento: 3 m<sup>2</sup> por litro

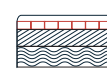

Mantiene los colores naturales



Resistente a los rayos UV



Secado rápido



Etiqueta

CÓDIGO	DESCRIPCIÓN	PRECIO	INNER	MASTER
CSEAL4L	4 L	\$ 200.00	1	1
CSEAL19L	19 L	\$ 650.00	1	1

El aspecto, empaque, inner o master de los productos puede variar sin previo aviso debido a la innovación continua de nuestras marcas.

## IMPERMEABILIZANTE REFORZADO DE CAUCHO

CÓDIGO	DESCRIPCIÓN	PRECIO	INNER
IMP1683	19 L, 7 años	\$ 1,140.00	1
IMP19L	19 L, 5 años	\$ 1,020.00	1
IMP643	19 L, 3 años	\$ 830.00	1



- Formulación de estireno y acrílico
- No necesita malla de refuerzo
- Propiedades elásticas
- Rendimiento: 1 m<sup>2</sup> por litro
- Reflejante (Blanco)
- Mejora la capacidad de aislamiento



- Se recomienda aplicarlo sobre superficies uniformes
- Alto desempeño en condiciones extremas de intemperie

**NO DEBE APLICARSE SOBRE CHAPOPOTE**

## IMPERMEABILIZANTE FIBRATADO

CÓDIGO	DESCRIPCIÓN	PRECIO	INNER
IMP19LFR	19 L, 7 años	\$ 1,140.00	1
IMP1685	19 L, 5 años	\$ 1,020.00	1
IMP645	19 L, 3 años	\$ 830.00	1



- Excelente adherencia en concreto, cemento, asbesto, piedra y ladrillo
- Formulación de estireno y acrílico
- No necesita malla de refuerzo
- Propiedades elásticas
- Rendimiento: 1 m<sup>2</sup> por litro
- Aislante
- Mejora la capacidad de aislamiento



- Se recomienda aplicarlo sobre superficies irregulares o con variedad de materiales
- Alto desempeño en condiciones extremas de intemperie

**NO DEBE APLICARSE SOBRE CHAPOPOTE**

## IMPERMEABILIZANTE REFORZADO DE CAUCHO



• No necesita malla de refuerzo



CÓDIGO	DESCRIPCIÓN	PRECIO	INNER
MPTC1686	19 L, 3 años	\$ 960.00	1
MPTC1687	19 L, 5 años	\$ 1,100.00	1
IMPT981	19 L, 7 años	\$ 1,320.00	1

## TERRACOTA

- Se recomienda aplicarlo sobre superficies irregulares o con variedad de materiales

- Alto desempeño en condiciones extremas de intemperie
- Excelente adherencia en concreto, cemento, asbesto, piedra y ladrillo
- Formulación de estireno y acrílico
- Propiedades elásticas
- Rendimiento: 1 m<sup>2</sup> por litro

**NO DEBE APLICARSE SOBRE CHAPOPOTE**



**PRESENTACIÓN 3 Y 5 AÑOS**

## IMPERMEABILIZANTE FIBRATADO



• No necesita malla de refuerzo



CÓDIGO	DESCRIPCIÓN	PRECIO	INNER
MPTF1684	19 L, 3 años	\$ 960.00	1
MPTF1685	19 L, 5 años	\$ 1,100.00	1
IMPT977	19 L, 7 años	\$ 1,320.00	1

## IMPERMEABILIZANTE PREMIUM REFUERZO DE FIBRA Y CAUCHO

CÓDIGO	DESCRIPCIÓN	PRECIO	INNER
IMPP1352	19 L, 10 años	\$ 1,500.00	1



- Excelente adherencia en concreto, cemento, asbesto, piedra y ladrillo
- Formulación de estireno y acrílico
- No es compatible con la malla de refuerzo
- Propiedades elásticas
- Rendimiento: 1 m<sup>2</sup> por litro
- Mejora la capacidad de aislamiento



**NO DEBE APLICARSE SOBRE CHAPOPOTE**

Excelente para lasas vírgenes  
Alto desempeño en condiciones extremas de intemperie

Cepillo

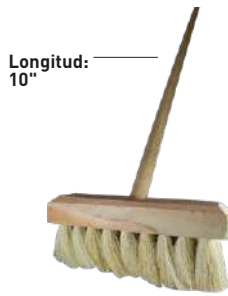

Longitud:  
10"



CÓDIGO	PRECIO	INNER	MASTER
C11778	\$ 92.00	1	80

Brocha de ixtle 5"



CÓDIGO	PRECIO	INNER	MASTER
B11777	\$ 34.00	1	100

Pinza para cubeta



Cuerpo de plástico



CÓDIGO	PRECIO	INNER	MASTER
PCA1059	\$ 51.00	1	30

**ADDMIX**

Compuesto para el tratamiento de juntas de tablaroca

Multiusos

Ideal para trabajos de resane y rellenos de junta en tablaroca

Protección contra el crecimiento de microorganismos durante su tiempo de anaquel

Fácil de lijar

Secado rápido



CÓDIGO	DESCRIPCIÓN	PRECIO	INNER	MASTER
CRM1240	5 kg	\$ 105.00	1	1
CRM1239	22 kg	\$ 350.00	1	1

**Espuma de poliuretano**

Máxima expansión  
Fijaciones  
Aislamientos  
Rellenos  
Insonorización

1.5 Años de vida (3 meses después de abrir)



EPME856

CÓDIGO	DESCRIPCIÓN	PRECIO	INNER	MASTER
EPME855	12 Oz 340 g	\$ 90.00	1	12
EPME856	20 Oz 566 g	\$ 140.00	1	12

**ADDWOOD PEGAMENTO AMARILLO PROFESIONAL**

- Adhesivo a base de agua
- Para maderas duras, blandas y sintéticas
- Pegamento que permite uniones altamente resistentes y permanentes
- Recomendado para uso en cartón y trabajos escolares artesanales
- Seca y no se cristaliza
- Transparente al secar

SOLIDOS 44%



CÓDIGO	DESCRIPCIÓN	PRECIO	MASTER
PBP858	1 L	\$ 110.00	12
PBP857	3.789 L	\$ 370.00	1
PBP906	19 L	\$ 1,600.00	1
PAP1873	200 L	\$ 15,500.00	1*
PAP1874	1000 L	\$ 72,000.00	1*

\* PEDIDOS ESPECIALES

**ADDWOOD PEGAMENTO AMARILLO**

- Adhesivo a base de agua
- Pegamento que permite uniones altamente resistentes y permanentes
- Recomendado para uso en cartón y trabajos escolares artesanales
- Seca y no se cristaliza
- Transparente al secar

SOLIDOS 35%



CÓDIGO	DESCRIPCIÓN	PRECIO	MASTER
PA1884	250 ml	\$ 44.00	24
PA1885	500 ml	\$ 63.00	12
PA1879	1 L	\$ 93.00	12
PA1878	3.789 L	\$ 335.00	1
PA1877	19 L	\$ 1,400.00	1
PA1882	200 L	\$ 13,700.00	1*
PA1883	1000 L	\$ 64,000.00	1*

**ADDWOOD PEGAMENTO BLANCO**

- Adhesivo a base de agua
- Pegamento que permite uniones altamente resistentes y permanentes
- Recomendado para uso en cartón y trabajos escolares artesanales
- Seca y no se cristaliza
- Transparente al secar

SOLIDOS 21%



CÓDIGO	DESCRIPCIÓN	PRECIO	MASTER
PB954	250 ml	\$ 42.00	24
PB955	500 ml	\$ 60.00	12
PB951	1 L	\$ 84.00	12
PB950	3.789 L	\$ 300.00	1
PB976	19 L	\$ 1,250.00	1
PB1875	200 L	\$ 12,000.00	1*
PB1876	1000 L	\$ 55,000.00	1*



# MASTERPROOF®

## SELLADORES Y PEGAMENTOS

MP0005, MP0006



### SELLADOR ACRÍLICO

**Pintable, excelente adherencia**

Sellador a base de acrílico que sella uniones en marcos de ventanas y puertas, zoclos y otras uniones con ligero movimiento. Adhiere materiales como vidrio, aluminio, concreto, madera, paneles de yeso y otros.

Sella espacios no mayores a **6 mm**.

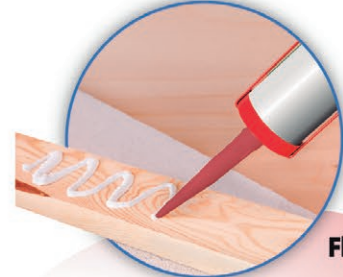

### POWER NAIL

**CLAVO LÍQUIDO**  
Flexible y extrafuerte

Adhesivo para aplicaciones industriales; pega materiales como ladrillo, madera, piso laminados, concreto y paneles de yeso, entre otros.

MP0007



### SILICÓN 100%

**Para vidrio recubierto y policarbonato**

Pega y hermetiza superficies lisas en vidrio, aluminio, cerámica porcelanizada, entre otros. Repara fugas pequeñas de agua y gas.



**Aplicación en superficies húmedas**



MP0001, MP0002

MP0010

### SILICÓN MULTIUSOS

**Para uso en el hogar**

Sella y hermetiza superficies lisas en vidrio, aluminio, acero, cerámica y porcelana

**Aplicación en superficies secas**



MP0003, MP0004

**MyPAT**  
cooler®



**ACCESORIOS PARA  
AIRE EVAPORATIVO**





## Ventilador de techo 56"

Funcionamiento silencioso  
Sin oscilaciones  
Ideal para habitaciones grandes  
Motor de gran durabilidad y potencia



FRECUENCIA Y POTENCIA NOMINAL		
127 V~	60 Hz	75 W
Velocidad de motor 280 RPM		



CÓDIGO	PRECIO	INNER	MASTER
MYAB1957	\$ 950.00	1	1

## Bomba sumergible para enfriador evaporativo



ESPECIFICACIONES TÉCNICAS	
VOLTAJE	127 V~
FRECUENCIA	60 Hz
POTENCIA	25 W
FLUJO MÁXIMO	1501 L/h
ALTURA MÁXIMA	3.5 m (3/8"), 2.3 m (1/2")

CÓDIGO	DESCRIPCIÓN	PRECIO	INNER	MASTER
MYBS1001	1501 L/h	\$ 175.00	1	24

## Bomba sumergible para enfriador evaporativo



ESPECIFICACIONES TÉCNICAS	
VOLTAJE	127 V~
FRECUENCIA	60 Hz
POTENCIA	25 W
FLUJO MÁXIMO	1500 L/h
ALTURA MÁXIMA	2.3 m

CÓDIGO	DESCRIPCIÓN	PRECIO	INNER	MASTER
MYBS1002	1500 L/h	\$ 175.00	1	24

## Bomba sumergible para enfriador evaporativo



ESPECIFICACIONES TÉCNICAS	
VOLTAJE	127 V~
FRECUENCIA	60 Hz
POTENCIA	16 W
FLUJO MÁXIMO	1500 L/h
ALTURA MÁXIMA	1.5 m

CÓDIGO	DESCRIPCIÓN	PRECIO	INNER	MASTER
MYBS1003	800 L/h	\$ 215.00	1	24

### Bomba para enfriadores evaporativos

- Motor con ventilador
- Clavija con conexión a tierra
- Protección de temperatura
- Fácil de limpiar
- Capacidad **5000 CFM**  
110 - 127 V~ 60 Hz 0.6 A
- 2900 RPM**
- Flujo de agua **18.3 L/min**



CÓDIGO	PRECIO	INNER	MASTER
BMP5000	\$ 250.00	1	15

### Bomba para enfriadores evaporativos

- Motor "Heavy Duty" con ventilador concéntrico
- Eje resistente a la corrosión de una sola pieza
- Clavija con conexión a tierra
- Protección de temperatura
- Cuerpo retardante de llamas
- Codo de **90°** con drenaje
- Malla de protección
- Placa de montaje
- Fácil de limpiar
- Capacidad **7500 a 15000 CFM**  
110-127 V~ 60 Hz 0.6 A
- Flujo de agua **18.3 L/min**



CÓDIGO	PRECIO	INNER	MASTER
BMP1341	\$ 520.00	1	12

### Motor para aire acondicionado

- Protección térmica automática
- 2 velocidades
- Embobinado de cobre
- 110 V~ 60 Hz
- Velocidad:  
Alta **1725 RPM**  
Baja **115 RPM**



CÓDIGO	DESCRIPCIÓN	PRECIO	INNER	MASTER
MAA823	1/2 HP	\$ 2,300.00	1	1
MAA824	3/4 HP	\$ 2,400.00	1	1

### Base metálica para motor de aire acondicionado



CÓDIGO	PRECIO	INNER	MASTER
BMM1235	\$ 85.00	1	48

### Control para aire acondicionado

- 130 V~ 60 Hz 20 A
- Rango del switch 1  
1/4 HP / 120 V~  
2 HP / 240 V~
- Controla aparatos evaporativos de 2 velocidades y bombas de agua
- 4 posiciones de trabajo, bomba e interruptor



CÓDIGO	PRECIO	INNER	MASTER
CONA	\$ 100.00	1	100

### Flotador para aire acondicionado anticorrosivo



CÓDIGO	DESCRIPCIÓN	PRECIO	INNER	MASTER
FLOBP14	1/4"	\$ 55.00	1	100
FLOBP38	3/8" Y 5/16"	\$ 50.00	1	100

### Flotador para aire acondicionado latón



CÓDIGO	DESCRIPCIÓN	PRECIO	INNER	MASTER
FLOB14	1/4"	\$ 133.00	1	100
FLOB38	3/8"	\$ 133.00	1	100

### Flotador para aire acondicionado 3/8" con adaptador a 1/4"



CÓDIGO	PRECIO	INNER	MASTER
FLOPE	\$ 38.70	1	120

El aspecto, empaque, inner o master de los productos puede variar sin previo aviso debido a la innovación continua de nuestras marcas.

## Válvula silleta

Regula el flujo de agua

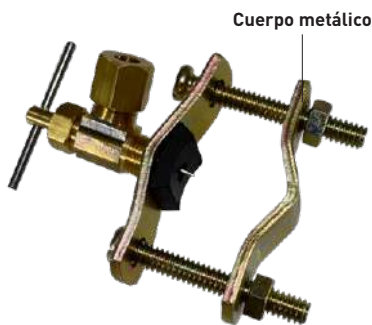

Cuerpo metálico



CÓDIGO	DESCRIPCIÓN	PRECIO	INNER	MASTER
VS14	1/4"	\$ 63.00	10	200
VS38	3/8"	\$ 65.00	10	200

## Válvula 1/2" X 1/2" X 1/4"

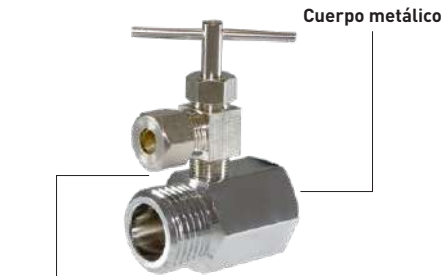

Cuerpo metálico

Cromada



CÓDIGO	DESCRIPCIÓN	PRECIO	INNER	MASTER
VS1212	1/2" x 1/2" x 1/4"	\$ 140.00	10	200

## Polea ajustable



Cuerpo de aluminio



CÓDIGO	DESCRIPCIÓN	PRECIO	INNER	MASTER
PAA31412	3 1/4" x 1/2"	\$ 120.00	1	100
PAA31458	3 1/4" x 5/8"	\$ 120.00	1	100

## Polea motriz

Cuerpo de aluminio

Para motor con ranura



CÓDIGO	DESCRIPCIÓN	PRECIO	INNER	MASTER
PMA212	2" x 1/2"	\$ 46.00	1	100
PMA258	2" x 5/8"	\$ 46.00	1	100
PMA21212	2 1/2" x 1/2"	\$ 55.00	1	100
PMA21258	2 1/2" x 5/8"	\$ 55.00	1	100
PMA312	3" x 1/2"	\$ 63.00	1	100
PMA358	3" x 5/8"	\$ 63.00	1	100

## Polea volante 7"

Cuerpo de aluminio

Para turbina con ranura



CÓDIGO	DESCRIPCIÓN	PRECIO	INNER	MASTER
PVA758	7" x 5/8"	\$ 125.00	1	20
PVA734	7" x 3/4"	\$ 125.00	1	20
PVA71	7" x 1"	\$ 125.00	1	20

## Polea volante 10"

Cuerpo de aluminio

Para turbina con ranura



CÓDIGO	DESCRIPCIÓN	PRECIO	INNER	MASTER
PVA1058	10" x 5/8"	\$ 210.00	1	20
PVA1034	10" x 3/4"	\$ 210.00	1	20
PVA101	10" x 1"	\$ 210.00	1	20

## Ánodo de magnesio para control de sarro

Protege de corrosión las partes metálicas



CÓDIGO	PRECIO	INNER	MASTER
AMG825	\$ 192.00	1	48

## Cedazo cuadrado tela mosquitera de aluminio



CÓDIGO	PRECIO	INNER	MASTER
CEDC	\$ 20.00	1	100

## Chumacera para enfriadores evaporativos



CÓDIGO	DESCRIPCIÓN	PRECIO	INNER	MASTER
CHUM58	5/8"	\$ 44.00	1	100
CHUM34	3/4"	\$ 46.00	1	100
CHUM1	1"	\$ 49.00	1	100

## Banda v para aire acondicionado

Para uso en maquinaria ligera

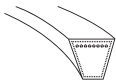

CÓDIGO	DESCRIPCIÓN	PRECIO	INNER	MASTER
MPB1735	40"	\$ 48.00	1	120
MPB1736	42"	\$ 48.00	1	120
MPB1737	43"	\$ 48.00	1	120
MPB1738	44"	\$ 50.00	1	120
MPB1739	45"	\$ 50.00	1	120
MPB1740	46"	\$ 50.00	1	125
MPB1741	47"	\$ 53.00	1	125
MPB1742	48"	\$ 53.00	1	120
MPB1743	49"	\$ 53.00	1	120
MPB1744	54"	\$ 55.00	1	100
MPB1745	55"	\$ 55.00	1	100
MPB1746	56"	\$ 55.00	1	100
MPB1747	57"	\$ 60.00	1	100
MPB1748	58"	\$ 60.00	1	100
MPB1749	59"	\$ 60.00	1	100
MPB1750	60"	\$ 60.00	1	100
MPB1751	61"	\$ 64.00	1	100
MPB1752	62"	\$ 64.00	1	100
MPB1753	63"	\$ 64.00	1	102
MPB1754	64"	\$ 64.00	1	102
MPB1755	65"	\$ 68.00	1	102
MPB1756	68"	\$ 68.00	1	85
MPB1757	70"	\$ 68.00	1	85

## Pastilla desodorante para aire acondicionado "DIAL"



CÓDIGO	PRECIO	INNER	MASTER
PD5255	\$ 78.00	1	48

## Rollo de poliducto 100 m



CÓDIGO	DESCRIPCIÓN	PRECIO	INNER	MASTER
RP14100	1/4"	\$ 173.00	1	15
RP38100	3/8"	\$ 230.00	1	5
RP516100	5/16"	\$ 195.00	1	10

## Sellador para aire evaporativo

Inhíbe la corrosión y el óxido

Forma una película sin traslapos

Base agua

Aplicación en frío

Propiedades elásticas

Resistente a la intemperie

30 minutos a 1 hora de secado

Fácil aplicación

Rendimiento: 1m<sup>2</sup> x L



CÓDIGO	PRECIO	INNER	MASTER
SAE1L	\$ 105.00	1	12

## Eliminador de sales para aire acondicionado "DIAL"

Amigable con el medio ambiente



CÓDIGO	PRECIO	INNER	MASTER
ES5284	\$ 152.00	1	10

## Distribuidor para aire acondicionado

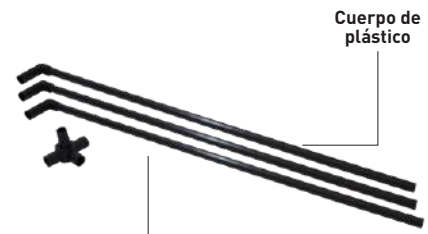

Distribuye agua de manera eficiente

Cuerpo de plástico



CÓDIGO	DESCRIPCIÓN	PRECIO	INNER	MASTER
DAA3V	3 vías	\$ 18.50	1	200
DAA4V	4 vías	\$ 22.50	1	150
DAA6V	6 vías	\$ 35.00	1	100
DAA8V	8 vías	\$ 44.00	1	100

## Aceite lubricante para aire zoom 118 ml "DIAL"



CÓDIGO	PRECIO	INNER	MASTER
AL5519	\$ 85.00	12	72

## Impermeabilizante para aire acondicionado "DIAL" 13 oz



CÓDIGO	PRECIO	INNER	MASTER
ID5324	\$ 198.00	1	12

El aspecto, empaque, inner o master de los productos puede variar sin previo aviso debido a la innovación continua de nuestras marcas.

## Dreen para aire acondicionado



Cuerpo de plástico



CÓDIGO	PRECIO	MASTER
DREEC	\$ 11.00	500

## Garbanzo compresión

Cuerpo de latón  
Bolsa individual con 50 piezas



CÓDIGO	DESCRIPCIÓN	PRECIO	INNER	MASTER
GAR14	1/4"	\$ 200.00	10	1000
GAR38	3/8"	\$ 220.00	10	1000
GAR516	5/16"	\$ 200.00	10	1000

## Niple compresión para poliducto

Cuerpo de latón



CÓDIGO	DESCRIPCIÓN	PRECIO	INNER	MASTER
NPB14	1/4"	\$ 24.00	5	300
NPB38	3/8"	\$ 36.00	5	300

## Niple terminal de compresión 3/8" x 1/2"

Cuerpo de latón  
Bolsa individual con 5 piezas

Con garbanzo y tuerca



CÓDIGO	PRECIO	INNER	MASTER
NTTG663	\$ 39.00	25	250

## Tuerca para poliducto

Cuerpo de latón



CÓDIGO	DESCRIPCIÓN	PRECIO	INNER	MASTER
TPB38	3/8"	\$ 9.00	10	1200
TPB14	1/4"	\$ 8.00	10	500

## Codo compresión para poliducto

Cuerpo de latón



CÓDIGO	DESCRIPCIÓN	PRECIO	INNER	MASTER
CPB14	1/4"	\$ 26.00	5	300
CPB38	3/8"	\$ 36.00	5	300

## Niple terminal de compresión 1/4" x 1/2"

Cuerpo de latón

Con garbanzo y tuerca



CÓDIGO	PRECIO	INNER	MASTER
NTTG662	\$ 37.00	25	250

## Garbanzo de 1/4" con espiga

Cuerpo de latón  
Bolsa individual con 25 piezas



CÓDIGO	PRECIO	INNER	MASTER
GARE14	\$ 7.50	250	1500

## Tee compresión para poliducto

Cuerpo de latón



CÓDIGO	DESCRIPCIÓN	PRECIO	INNER	MASTER
TEPB14	1/4"	\$ 37.00	5	300
TEPB38	3/8"	\$ 52.00	5	200



**CERROJOS, HERRAJES  
Y TORNILLERÍA**



## Cerrojo electrónico

Cierre con una tecla

Cilindro ajustable de 60 o 70 mm

50 códigos de usuario

Modo vacaciones

Indicador de batería



Incluye 2 llaves

CÓDIGO	DESCRIPCIÓN	INNER	MASTER
SHCE2063	Humo	1	6

## Cerrojo electrónico

Cierre con una tecla

Cilindro ajustable de 60 o 70 mm

50 códigos de usuario

Modo vacaciones

Indicador de batería



Incluye 2 llaves

CÓDIGO	DESCRIPCIÓN	INNER	MASTER
SHCE2062	Níquel satinado	1	6

## Cerrojo llave/botón

Cilindro de latón

Mecanismo tubular



Incluye 3 llaves



CÓDIGO	DESCRIPCIÓN	INNER	MASTER
SHCP2060	Negro mate	6	24

## Cerradura manija

Cilindro de latón

Mecanismo tubular



Incluye 3 llaves

De seguridad



CÓDIGO	DESCRIPCIÓN	INNER	MASTER
SHCP2057	Negro mate	6	12

## Cerradura manija

Cilindro de latón

Mecanismo tubular



De privacidad



CÓDIGO	DESCRIPCIÓN	INNER	MASTER
SHCP2056	Negro mate	6	12

## Cerrojo llave/llave

Cilindro de latón

Mecanismo tubular



Incluye 3 llaves



CÓDIGO	DESCRIPCIÓN	INNER	MASTER
SHCP2061	Negro mate	6	24

## Combo cerradura manija y cerrojo llave/llave

De seguridad



Incluye 3 llaves



CÓDIGO	DESCRIPCIÓN	INNER	MASTER
SHCP2058	Negro mate	6	12

## Combo cerradura manija y cerrojo llave/botón

De privacidad



Incluye 3 llaves



CÓDIGO	DESCRIPCIÓN	INNER	MASTER
SHCP2059	Negro mate	6	12

## Botón níquel



CÓDIGO	INNER	MASTER
SHBN1984	50	500

## Jaladera de sobreponer

Cuerpo de aluminio



CÓDIGO	DESCRIPCIÓN	INNER	MASTER
JN1961AL	397 mm	10	100

## Jaladera

Cuerpo de aluminio



CÓDIGO	DESCRIPCIÓN	INNER	MASTER
J1963A	160 mm	20	200
J1964A	192 mm	20	200

## Jaladera

Cuerpo de aluminio



CÓDIGO	LARGO	INN.	MAS.
SHJA2012	240 mm	50	500

El aspecto, empaque, inner o master de los productos puede variar sin previo aviso debido a la innovación continua de nuestras marcas.

## Bóton negro

Cuerpo de aluminio



CÓDIGO	DESCRIPCIÓN	INN.	MAS.
SHBA2010	63 x 63 mm	50	500

## Jaladera

Cuerpo de aluminio



CÓDIGO	LARGO	INN.	MAS.
SHJA2053	140 mm	50	500

## Jaladera

Cuerpo de aluminio



CÓDIGO	DESCRIPCIÓN	INN.	MAS.
SHJA2009	63 x 63 mm	50	500

## Jaladera

Cuerpo de aluminio



CÓDIGO	LARGO	INN.	MAS.
SHJA2011	150 mm	50	500

## Jaladera

Cuerpo metálico



CÓDIGO	DESCRIPCIÓN	INN.	MAS.
SHJA1985	10 mm	50	500

## Soporte para repisa con perno

7.5 mm grosor máximo



Tornillo ajustable

CÓDIGO	DESCRIPCIÓN	INN.	MAS.
SHSV2013	7 mm de largo	20	200

## Separador para cristal



Cromado satinado

CÓDIGO	DESCRIPCIÓN	INN.	MAS.
SHSV2020	46 x 26 x 30 mm	20	200
SHSV2021	58 x 33 x 38 mm	12	120

## Soporte para repisa

Tipo pelicano



Negro

Tornillo ajustable

CÓDIGO	DESCRIPCIÓN	INN.	MAS.
SHSV2064	40 x 40 mm	20	200
SHSV2065	55 x 55 mm	12	120
SHSV2066	60 x 75 mm	10	100

## Soporte para repisa

Tipo pelicano



Níquel satinado

Tornillo ajustable

CÓDIGO	DESCRIPCIÓN	INN.	MAS.
SHSV2014	40 x 40 mm	20	200
SHSV2015	55 x 55 mm	12	120
SHSV2016	60 x 75 mm	10	100

## Soporte para repisa

Tipo pelicano



Cromado

Tornillo ajustable

CÓDIGO	DESCRIPCIÓN	INN.	MAS.
SHSV2017	40 x 40 mm	20	200
SHSV2018	55 x 55 mm	12	120
SHSV2019	60 x 75 mm	10	100

## Tope de piso para puerta



Níquel satinado

CÓDIGO	DESCRIPCIÓN	INN.	MAS.
SHTP2022	Diámetro 38 mm	20	200

## Tope para puerta lateral

73 x 25 mm



SHTP2024

SHTP2025

SHTP2026

CÓDIGO	DESCRIPCIÓN	INN.	MAS.
SHTP2024	Humo	20	200
SHTP2025	Cromado satinado	20	200
SHTP2026	Cromado	20	200

## Tope de piso para puerta

45 mm de alto



Cromado

CÓDIGO	DESCRIPCIÓN	INN.	MAS.
SHTP2023	Diámetro 38 mm	20	200

El aspecto, empaque, inner o master de los productos puede variar sin previo aviso debido a la innovación continua de nuestras marcas.



**Pasador de cadena con barra**  
113 x 35 x 84 mm



CÓDIGO	DESCRIPCIÓN	INN.	MAS.
SHPP2027	Cromado satinado	12	72
SHPP2028	Humo	12	72
SHPP2029	Cromado	12	72

**Pasador de cadena con barra**



CÓDIGO	DESCRIPCIÓN	INN.	MAS.
SHPP2030	107 x 62 mm	10	100

**Pasador para puerta de broche redondo**



CÓDIGO	DESCRIPCIÓN	INN.	MAS.
SHPP2031	41 x 40 mm	20	200
SHPP2032	55 x 55 mm	20	200

**Pasador para puerta de broche**

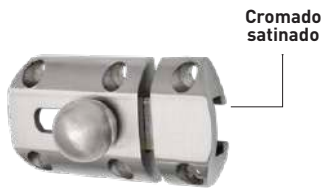

CÓDIGO	DESCRIPCIÓN	INN.	MAS.
SHPP2033	63 x 24 x 34 mm	20	200

**Pasador para puerta de gancho 2 piezas**



CÓDIGO	DESCRIPCIÓN	INN.	MAS.
SHPP2034	170 x 18 x 41 mm	20	200

**Cerradura para ventana**  
17 x 33 mm

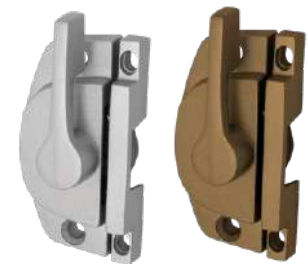

CÓDIGO	DESCRIPCIÓN	INN.	MAS.
SHCV2039	Humo	20	200
SHCV2040	Cromado satinado	20	200

**Pasador de embutir**



CÓDIGO	DESCRIPCIÓN	INN.	MAS.
SHEM2035	150 mm	20	200
SHEM2036	200 mm	20	200

**Pasador de embutir**



CÓDIGO	DESCRIPCIÓN	INN.	MAS.
SHEM2037	150 mm	20	200
SHEM2038	200 mm	20	200

**Número de casa negro 3"**

**01234**

**56789**

**Tope para puerta de pared**  
30 x 57 mm



CÓDIGO	DESCRIPCIÓN	INN.	MAS.
SHTP2041	Níquel satinado	20	200
SHTP2042	Cromado satinado	20	200

CÓDIGO	DESCRIPCIÓN	INNER	MASTER
SHNC2043	No. 0	20	200
SHNC2044	No. 1	20	200
SHNC2045	No. 2	20	200
SHNC2046	No. 3	20	200
SHNC2047	No. 4	20	200

CÓDIGO	DESCRIPCIÓN	INNER	MASTER
SHNC2048	No. 5	20	200
SHNC2049	No. 6	20	200
SHNC2050	No. 7	20	200
SHNC2051	No. 8	20	200
SHNC2052	No. 9	20	200

El aspecto, empaque, inner o master de los productos puede variar sin previo aviso debido a la innovación continua de nuestras marcas.

## Cerradura para puerta principal "Barcelona" Producto sujeto a disponibilidad\*

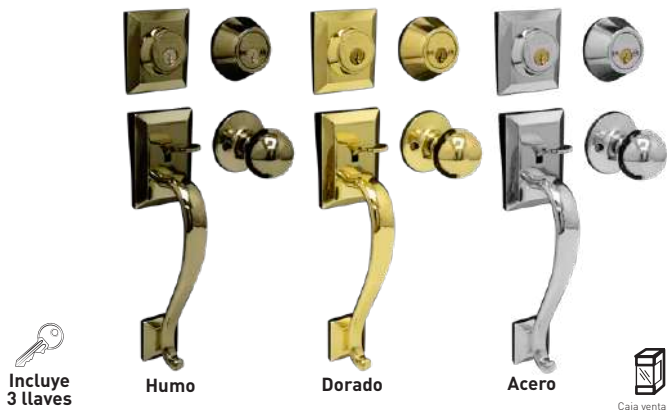

CÓDIGO	DESCRIPCIÓN	PRECIO	INNER	MASTER
3881PB	Dorado	\$ 900.00	1	6
3881AB	Humo	\$ 900.00	1	6
3881SS	Acero	\$ 900.00	1	6

## Cerradura para puerta principal "Manchester" Producto sujeto a disponibilidad\*

Alto: 35 cm  
Ancho: 7 cm



CÓDIGO	DESCRIPCIÓN	PRECIO	INNER	MASTER
3891PB	Dorado	\$ 800.00	1	6
3891AB	Humo	\$ 800.00	1	6
3891SS	Acero	\$ 800.00	1	6

## Cerradura para puerta principal oval manillón mediano



CÓDIGO	DESCRIPCIÓN	PRECIO	INNER	MASTER
805872PB	Dorado	\$ 720.00	1	6
805872AB	Humo	\$ 720.00	1	6
805872SS	Acero	\$ 720.00	1	6



## Cerradura para puerta principal "Venecia"

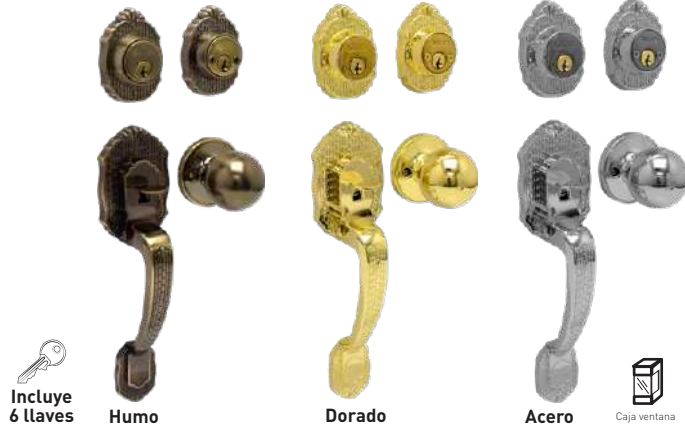

CÓDIGO	DESCRIPCIÓN	PRECIO	INNER	MASTER
806872PB	Dorado	\$ 850.00	1	6
806872AB	Humo	\$ 850.00	1	6
806872SS	Acero	\$ 850.00	1	6

## Cerradura para puerta principal "Oasis"



CÓDIGO	DESCRIPCIÓN	PRECIO	INNER	MASTER
801872PB	Dorado	\$ 850.00	1	6
801872AB	Humo	\$ 850.00	1	6
801872SS	Acero	\$ 850.00	1	6



## Cerradura para puerta principal "Dublín"

Alto: 45 cm  
Ancho: 8 cm



CÓDIGO	DESCRIPCIÓN	PRECIO	INNER	MASTER
8202PB	Dorado	\$ 910.00	1	6
8202AB	Humo	\$ 910.00	1	6
8202SS	Acero	\$ 910.00	1	6

El aspecto, empaque, inner o master de los productos puede variar sin previo aviso debido a la innovación continua de nuestras marcas.

## Cerradura para puerta principal "Colonial" doble seguridad



CÓDIGO	DESCRIPCIÓN	PRECIO	INNER	MASTER
8093PB	Dorado	\$ 1000.00	1	6
8093AB	Humo	\$ 1000.00	1	6
8093SS	Acero	\$ 1000.00	1	6

## Cerradura para puerta principal "Savana" doble seguridad

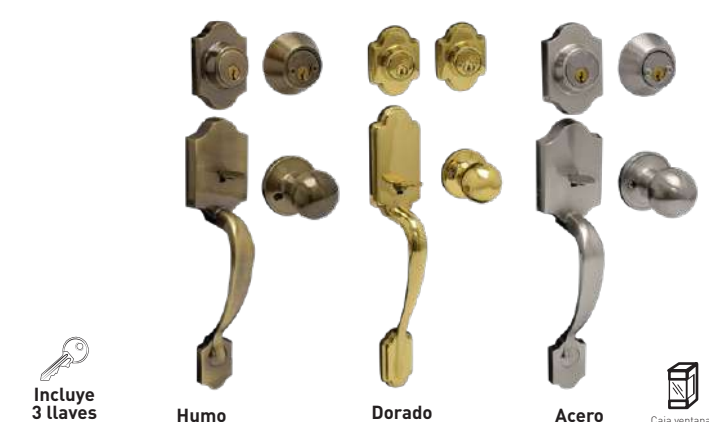

CÓDIGO	DESCRIPCIÓN	PRECIO	INNER	MASTER
803872PB	Dorado	\$ 985.00	1	6
803872AB	Humo	\$ 985.00	1	6
803872SS	Acero	\$ 985.00	1	6

## Cerradura para puerta principal "Stuttgart" Producto sujeto a disponibilidad\*

Alto: 43 cm  
Ancho: 6 cm



CÓDIGO	DESCRIPCIÓN	PRECIO	INNER	MASTER
8101PB	Dorado	\$ 1000.00	1	6
8101AB	Humo	\$ 1000.00	1	6
8101SS	Acero	\$ 1000.00	1	6

## Cerradura para puerta principal "Mabel" doble seguridad Producto sujeto a disponibilidad\*

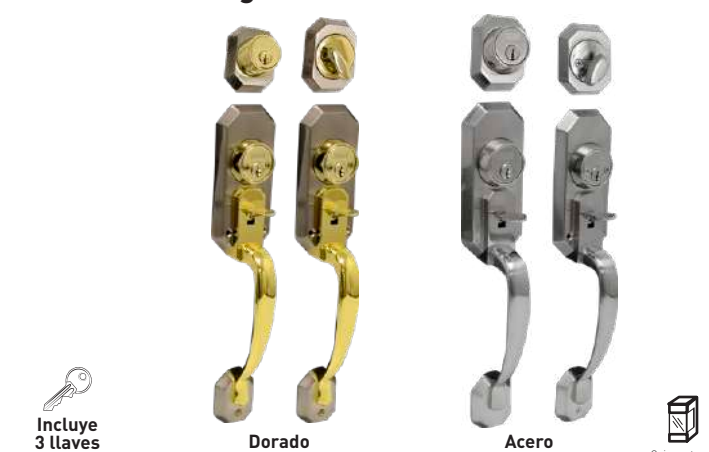

CÓDIGO	DESCRIPCIÓN	PRECIO	INNER	MASTER
8083SS	Acero	\$ 1,200.00	1	6
8083SD	Acero / Dorado	\$ 1,600.00	1	6

## Cerradura para puerta principal "Copenhague" Producto sujeto a disponibilidad\*

Alto: 39 cm  
Ancho: 7 cm



CÓDIGO	DESCRIPCIÓN	PRECIO	INNER	MASTER
8103PB	Dorado	\$ 1,600.00	1	6
8103AB	Humo	\$ 1,600.00	1	6

## Cerradura para puerta principal "Milan" doble seguridad

Alto: 42 cm  
Ancho: 7 cm



CÓDIGO	DESCRIPCIÓN	PRECIO	INNER	MASTER
8206PB	Dorado	\$ 1,800.00	1	6
8206AB	Humo	\$ 1,800.00	1	6
8206SS	Acero	\$ 1,800.00	1	6

## Cerradura pomo

Tipo esfera  
Cilindro de latón  
Mecanismo tubular



CÓDIGO	DESCRIPCIÓN	PRECIO	INN.	MAS.
6872PB	Dorado privacidad	\$ 210.00	6	24
6872AB	Humo privacidad	\$ 210.00	6	24
6872SS	Acero privacidad	\$ 210.00	6	24

## Cerradura pomo

Tipo esfera  
Cilindro de latón  
Mecanismo tubular



CÓDIGO	DESCRIPCIÓN	PRECIO	INN.	MAS.
6871PB	Dorado seguridad	\$ 225.00	6	24
6871AB	Humo seguridad	\$ 225.00	6	24
6871SS	Acero seguridad	\$ 225.00	6	24

## Cerradura manija

Cilindro de latón  
Mecanismo tubular



CÓDIGO	DESCRIPCIÓN	PRECIO	INN.	MAS.
6452PB	Dorado privacidad	\$ 340.00	6	24
6452AB	Humo privacidad	\$ 340.00	6	24
6452SS	Acero privacidad	\$ 340.00	6	24

## Cerradura manija

Cilindro de latón  
Mecanismo tubular



CÓDIGO	DESCRIPCIÓN	PRECIO	INN.	MAS.
6451PB	Dorado seguridad	\$ 360.00	6	24
6451AB	Humo seguridad	\$ 360.00	6	24
6451SS	Acero seguridad	\$ 360.00	6	24

## Cerradura manija

Cilindro de latón  
Mecanismo tubular



CÓDIGO	DESCRIPCIÓN	PRECIO	INN.	MAS.
6461PB	Dorado seguridad	\$ 340.00	6	24
6461AB	Humo seguridad	\$ 340.00	6	24
6461SS	Acero seguridad	\$ 340.00	6	24

## Cerradura manija

Cilindro de latón  
Mecanismo tubular

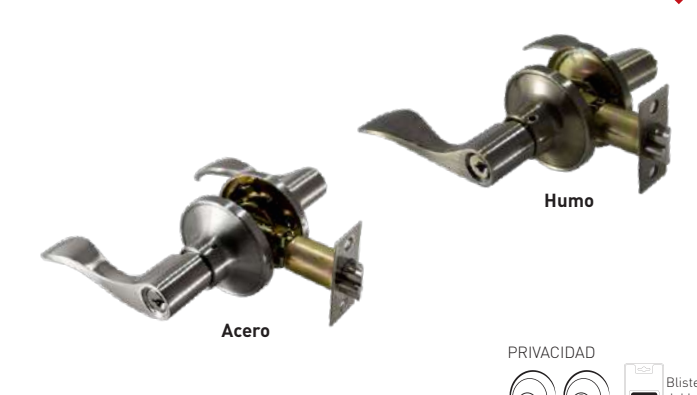

CÓDIGO	DESCRIPCIÓN	PRECIO	INN.	MAS.
6462AB	Humo privacidad	\$ 330.00	6	24
6462SS	Acero privacidad	\$ 330.00	6	24

## Cerradura manija

Cilindro de latón  
Mecanismo tubular



Seguridad  
Incluye  
3 llaves



Privacidad



Seguridad



CÓDIGO	DESCRIPCIÓN	PRECIO	INNER	MASTER
3502SS	Acero privacidad	\$ 270.00	6	24
3501SS	Acero seguridad	\$ 280.00	6	24

## Cerradura manija

Cilindro de latón  
Mecanismo tubular



Seguridad  
Incluye  
3 llaves



Privacidad



Seguridad



CÓDIGO	DESCRIPCIÓN	PRECIO	INNER	MASTER
6432SS	Acero privacidad	\$ 320.00	6	24
6431SS	Acero seguridad	\$ 360.00	6	24

## Cerradura manija

Cilindro de latón  
Mecanismo tubular



Seguridad  
Incluye  
3 llaves



Privacidad



Seguridad



CÓDIGO	DESCRIPCIÓN	PRECIO	INNER	MASTER
6442SS	Acero privacidad	\$ 660.00	6	12
6441SS	Acero seguridad	\$ 700.00	6	12

## Cerrojo

Cilindro de latón  
Mecanismo tubular



Incluye  
3 llaves



Doble



Mariposa



CÓDIGO	DESCRIPCIÓN	PRECIO	INNER	MASTER
9807SS	Doble llave	\$ 375.00	6	12
9808SS	Mariposa	\$ 375.00	6	12

## Combo cerradura para embutir recámara

Producto  
**NUEVO**

Para puertas de  
35 a 45 mm

Para puerta  
izquierda y  
derecha

Cerrojo en dos  
pasos

Incluye 3  
llaves



Manija tipo "L"  
reversible



Producto sujeto a  
disponibilidad\*

CÓDIGO	DESCRIPCIÓN
SHCE2070	Niquel

## Combo cerradura para embutir entrada

Producto  
**NUEVO**

Para puertas  
de 35 a 45 mm

Para puerta  
izquierda y  
derecha

Cerrojo en dos  
pasos

Incluye 3  
bulones  
de acero de  
seguridad



Alta  
seguridad

Manija tipo "L"  
reversible



Producto sujeto a  
disponibilidad\*

CÓDIGO	DESCRIPCIÓN
SHCE2068	Niquel

## Combo cerradura para embutir baño

Producto  
**NUEVO**

Para puertas de  
35 a 45 mm

Para puerta  
izquierda y  
derecha

Cerrojo de  
1 paso



Manija tipo "L"  
reversible



Producto sujeto a  
disponibilidad\*

CÓDIGO	DESCRIPCIÓN
SHCE2069	Niquel

## Cerrojo cilindro doble

Cilindro de latón

Incluye 3 llaves



CÓDIGO	DESCRIPCIÓN	PRECIO	INNER	MASTER
7312PB	Dorado	\$ 280.00	6	24
7312AB	Humo	\$ 280.00	6	24
7312SS	Acero	\$ 280.00	6	24

## Cerrojo cilindro-mariposa

Cilindro de latón

Incluye 3 llaves



CÓDIGO	DESCRIPCIÓN	PRECIO	INNER	MASTER
7301PB	Dorado	\$ 240.00	6	24
7301AB	Humo	\$ 240.00	6	24
7301SS	Acero	\$ 240.00	6	24

## Combo cerradura pomo (6871) y cerrojo llave/mariposa (7301)

Cilindro de latón  
Mecanismo tubular

Incluye 3 llaves



CÓDIGO	DESCRIPCIÓN	PRECIO	INNER	MASTER
PCECSD	Dorado seguridad	\$ 460.00	6	12
PCECSH	Humo seguridad	\$ 460.00	6	12
PCECSS	Acero seguridad	\$ 460.00	6	12

## Combo cerradura pomo (6871) y cerrojo llave/llave (7312)

Cilindro de latón  
Mecanismo tubular

Incluye 3 llaves

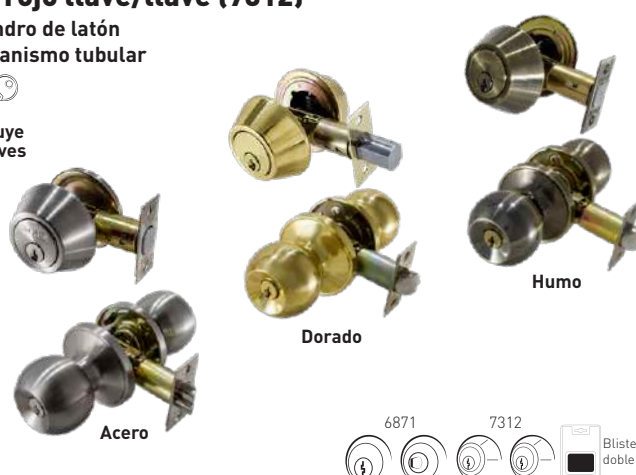

CÓDIGO	DESCRIPCIÓN	PRECIO	INNER	MASTER
PCECDD	Dorado seguridad	\$ 480.00	6	12
PCECDH	Humo seguridad	\$ 480.00	6	12
PCECDS	Acero seguridad	\$ 480.00	6	12

## Combo cerradura manija (6451) y cerrojo llave/mariposa (7301)

Cilindro de latón  
Mecanismo tubular

Incluye 3 llaves



CÓDIGO	DESCRIPCIÓN	PRECIO	INNER	MASTER
PCMCSD	Dorado seguridad	\$ 490.00	6	12
PCMCSH	Humo seguridad	\$ 490.00	6	12
PCMCS	Acero seguridad	\$ 490.00	6	12

## Combo cerradura manija (6451) y cerrojo llave/llave (7312)

Cilindro de latón  
Mecanismo tubular

Incluye 3 llaves

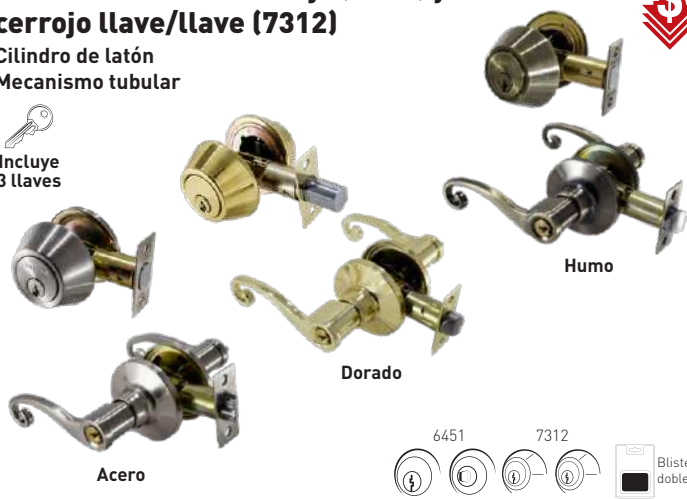

CÓDIGO	DESCRIPCIÓN	PRECIO	INN.	MAS.
PCMCDD	Dorado seguridad	\$ 550.00	6	12
PCMC DH	Humo seguridad	\$ 550.00	6	12
PCMCDS	Acero seguridad	\$ 550.00	6	12

El aspecto, empaque, inner o master de los productos puede variar sin previo aviso debido a la innovación continua de nuestras marcas.

## Combo cerradura manija (6431SS) y cerrojo llave/llave (7312SS)

De seguridad  
Cilindro de latón  
Mecanismo tubular

Incluye  
3 llaves



Acero



CÓDIGO	DESCRIPCIÓN	PRECIO	INN.	MAS.
PC6431S	Llave/llave	\$ 685.00	6	12

## Combo cerradura manija (6431SS) y cerrojo llave/mariposa (7301SS)

De seguridad  
Cilindro de latón  
Mecanismo tubular

Incluye  
3 llaves



Acero



CÓDIGO	DESCRIPCIÓN	PRECIO	INN.	MAS.
PC6432S	Llave/mariposa	\$ 655.00	6	12

## Combo cerradura manija (6461SS) y cerrojo llave/llave (7312SS)

De seguridad  
Cilindro de latón  
Mecanismo tubular

Incluye  
3 llaves



Acero



CÓDIGO	DESCRIPCIÓN	PRECIO	INN.	MAS.
PC6461S	Llave/llave	\$ 530.00	6	12

## Combo cerradura manija (6461SS) y cerrojo llave/mariposa (7301SS)

De seguridad  
Cilindro de latón  
Mecanismo tubular

Incluye  
3 llaves



Acero



CÓDIGO	DESCRIPCIÓN	PRECIO	INN.	MAS.
PC6462S	Llave/mariposa	\$ 490.00	6	12

## Combo cerradura manija (6441SS) y cerrojo llave/llave (9807SS)

Cilindro de latón  
Mecanismo tubular

Incluye  
3 llaves

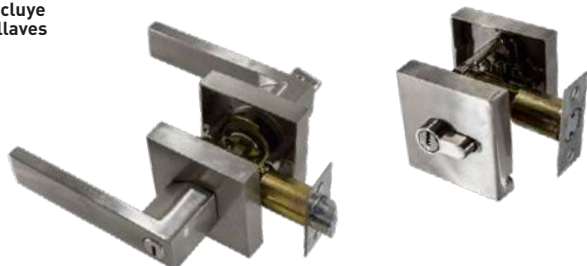

CÓDIGO	DESCRIPCIÓN	PRECIO	INNER	MASTER
PC1424S	Acero	\$ 950.00	6	12

## Combo cerradura manija (6441SS) y cerrojo llave/mariposa (9808SS)

Cilindro de latón  
Mecanismo tubular

Incluye  
3 llaves

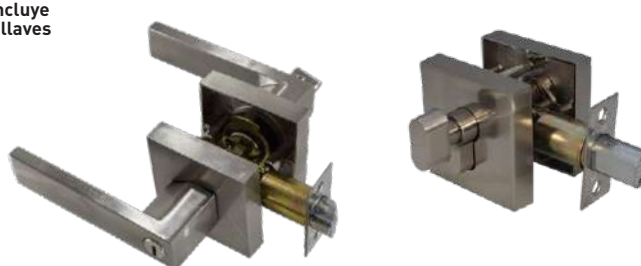

CÓDIGO	DESCRIPCIÓN	PRECIO	INNER	MASTER
PC1425S	Acero	\$ 900.00	6	12

## Cerradura de sobreponer

Espesor de puerta: 45 mm  
5 Pernos  
Cilindro de latón



Incluye 3 llaves



2391DI



2391DD



## Cerradura de sobreponer fácil instalación

Espesor de puerta: 45 mm  
5 Pernos  
Cilindro de latón



Incluye 3 llaves



2391FI



2391FD



CÓDIGO	DESCRIPCIÓN	PRECIO	INNER	MASTER
2391DI	Izquierda	\$ 180.00	1	24
2391DD	Derecha	\$ 180.00	1	24

CÓDIGO	DESCRIPCIÓN	PRECIO	INNER	MASTER
2391FI	Izquierda	\$ 210.00	6	24
2391FD	Derecha	\$ 210.00	6	24

## Cerradura de sobreponer doble cilindro

Para puertas corredizas y abatibles  
Puertas de madera o metálicas  
5 Pernos  
Cerrojo de botón  
Cilindro y cuerpo de latón



Incluye 3 llaves

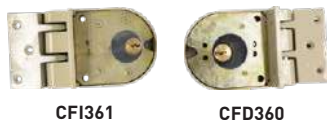

CFI361

CFD360



CFI361



CFD360



## Cerradura eléctrica

Puertas izquierdas o derechas  
Puede usarse con puertas de apertura interior  
Incluye transformador  
Llave de seguridad



Incluye 3 llaves

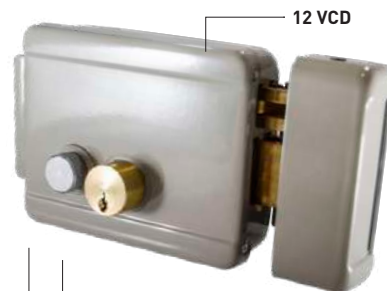

12 VCD

Botón para activar interior

Cilindro de latón



CÓDIGO	DESCRIPCIÓN	PRECIO	INNER	MASTER
CFI361	Izquierda	\$ 450.00	1	30
CFD360	Derecha	\$ 450.00	1	30

CÓDIGO	PRECIO	INNER	MASTER
CELE641	\$ 900.00	1	12



## Cerradura para mueble

5 Pernos  
29 mm

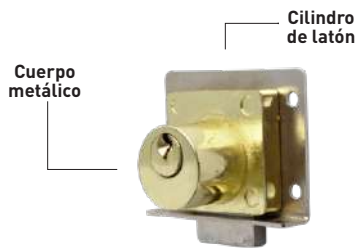

CÓDIGO	DESCRIPCIÓN	PRECIO	INNER	MASTER
C2240D	Dorado	\$ 100.00	6	72

## Cerradura para mueble

Incluye  
2 llaves



CÓDIGO	DESC.	PRECIO	INN.	MAS.
C10316	16 mm	\$ 45.00	20	240
C10320	20 mm	\$ 50.00	20	240
C10325	25 mm	\$ 55.00	20	240
C10330	30 mm	\$ 60.00	20	240

## Cerradura para cajón

25 mm

Incluye  
2 llaves



CÓDIGO	DESC.	PRECIO	INN.	MAS.
CF376	Cromo	\$ 50.00	36	144
CF377	Dorado	\$ 50.00	36	144

## Cerradura

22 mm

Incluye  
2 llaves



CÓDIGO	PRECIO	INNER	MASTER
SHCC1991	\$ 20.00	24	240

## Cerradura para mueble

cromo  
20 mm

Incluye  
2 llaves



CÓDIGO	PRECIO	INNER	MASTER
C12220C	\$ 78.00	20	240

## Cerradura para puerta corrediza tipo botón

Incluye  
2 llaves



CÓDIGO	DESC.	PRECIO	INN.	MAS.
CF379	Dorado	\$ 99.00	12	72

## Cerradura para cajón

22 mm

Incluye  
2 llaves

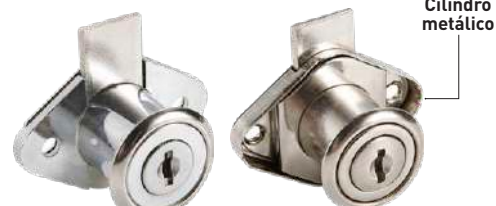

CÓDIGO	DESC.	PRECIO	INN.	MAS.
SHCC1989	Metálico	\$ 30.00	24	240
SHCC1990	Acero	\$ 25.00	24	240

## Cerradura para closet

Cilindro de latón



CÓDIGO	DESCRIPCIÓN	PRECIO	INNER	MASTER
CF380	29 mm cromado	\$ 105.00	6	36
CF381	29 mm dorado	\$ 105.00	6	36
CF382	36 mm cromado	\$ 120.00	6	36
CF383	36 mm dorado	\$ 120.00	6	36

## Pasador para puerta

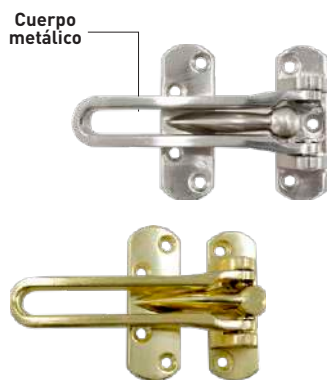

CÓDIGO	DESCRIPCIÓN	PRECIO	INN.	MAS.
PASDA07	Dorado	\$ 110.00	6	120
PASS07	Níquel satinado	\$ 110.00	6	120

## Cerradura para ventana

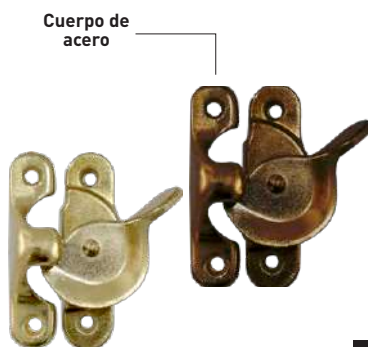

CÓDIGO	DESCRIPCIÓN	PRECIO	INNER	MASTER
PASSLD	Dorado	\$ 50.00	20	100
PASSLH	Humo	\$ 50.00	20	100

## Pasador para puerta con cadena

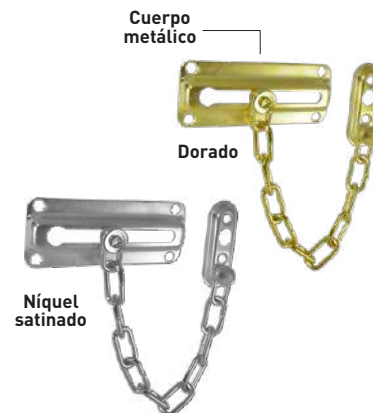

CÓDIGO	DESCRIPCIÓN	PRECIO	INN.	MAS.
P828PB	Dorado	\$ 40.00	20	200
P828SS	Níquel satinado	\$ 40.00	20	200

## Pasador de sobreponer

Pasador robusto

Para puertas y ventanas

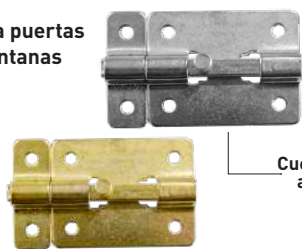

Cuerpo de acero

Botón de seguridad



CÓDIGO	DESCRIPCIÓN	PRECIO	INN.	MAS.
PALT212	Acero dorado 2 1/2"	\$ 50.00	6	36
PALT414	Acero dorado 4 1/4"	\$ 55.00	6	36
PALT512	Acero dorado 5 1/2"	\$ 80.00	6	36
PACR212	Acero cromado 2 1/2"	\$ 50.00	6	36
PACR414	Acero cromado 4 1/4"	\$ 55.00	6	36
PACR512	Acero cromado 5 1/2"	\$ 80.00	6	36

## Portacandado

Para instalaciones izquierdas o derechas

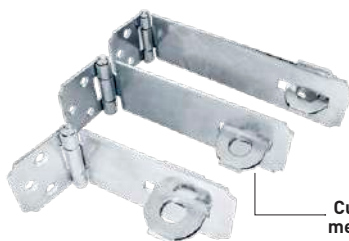

Cuerpo metálico



CÓDIGO	DESCRIPCIÓN	PRECIO	INNER	MASTER
PC212	2 1/2"	\$ 25.00	12	240
PC312	3 1/2"	\$ 30.00	12	240
PC412	4 1/2"	\$ 35.00	12	240
PC6	6"	\$ 40.00	12	240

## Pasador para portón

Para instalaciones izquierdas o derechas

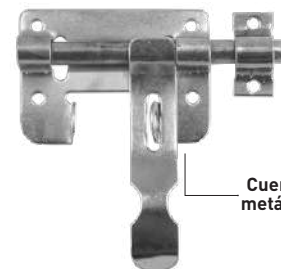

Cuerpo metálico



CÓDIGO	DESCRIPCIÓN	PRECIO	INNER	MASTER
PESP1773	3"	\$ 26.00	1	100
PESP1774	4"	\$ 37.00	1	72
PESP1775	6"	\$ 60.00	1	35
PESP1776	8"	\$ 67.00	1	25

## Pasador de barril

Adaptable a cualquier puerta



Cuerpo de acero



CÓDIGO	DESCRIPCIÓN	PRECIO	INNER	MASTER
PP4A	4"	\$ 40.00	60	240
PP6A	6"	\$ 50.00	50	200

## Pasador para puerta

Incluye accesorios para instalación



3 Llaves tetra



Cerrojo de barra en acero

Cromado

Cilindro de latón



CÓDIGO	DESCRIPCIÓN	PRECIO	INNER	MASTER
2900D	Derecha	\$ 340.00	1	24
2900I	Izquierda	\$ 340.00	1	24

## Pasador para puerta

Incluye accesorios para instalación

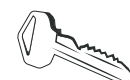

3 Llaves dentadas



Cerrojo de barra en acero

Cromado

Cilindro de latón



CÓDIGO	DESCRIPCIÓN	PRECIO	INNER	MASTER
2800D	Derecha	\$ 290.00	1	24
2800I	Izquierda	\$ 290.00	1	24

# TOPES



## Tope de puerta tipo domo

Cabeza de goma

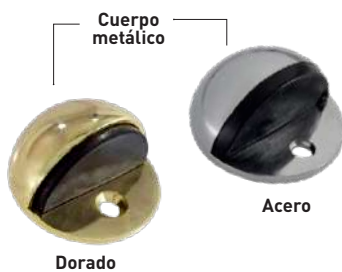

CÓDIGO	DESCRIPCIÓN	PRECIO	INNER	MASTER
TPPD	Dorado	\$ 45.00	12	72
TPPSS	Acero	\$ 45.00	12	72

## Tope para puerta tipo codo

Cabeza de goma



CÓDIGO	DESCRIPCIÓN	PRECIO	INNER	MASTER
TPTC586	Dorado	\$ 55.00	6	36
TPTC587	Acero	\$ 55.00	6	36

## Tope magnético para puerta

Cabeza con imán



CÓDIGO	DESCRIPCIÓN	PRECIO	INNER	MASTER
TPMP588	Dorado	\$ 85.00	6	36
TPMP589	Acero	\$ 85.00	6	36

## Tope para puerta superior



CÓDIGO	DESCRIPCIÓN	PRECIO	INNER	MASTER
TPSD	Dorado	\$ 36.00	12	120

## Tope para puerta



CÓDIGO	DESCRIPCIÓN	PRECIO	INNER	MASTER
T2014C	Cromado	\$ 95.00	6	48
T2014AB	Humo	\$ 95.00	6	48
T2014SS	Acero	\$ 95.00	6	48
T2014D	Dorado	\$ 95.00	6	48

## Tope para puerta lateral

Cabeza de goma  
Montura a muro

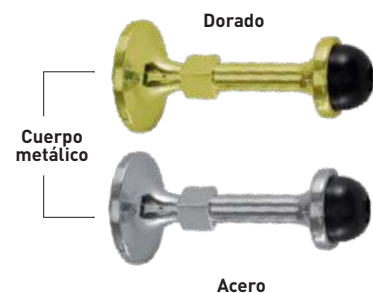

CÓDIGO	DESCRIPCIÓN	PRECIO	INNER	MASTER
TPPLD	Dorado	\$ 45.00	12	120
TPPLSS	Acero	\$ 45.00	12	120

## Tope para puerta

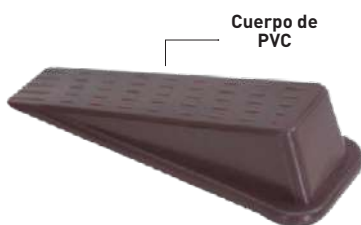

CÓDIGO	DESCRIPCIÓN	PRECIO	INNER	MASTER
TPPC708	Café	\$ 21.00	10	200

## Soporte para pasamanos



CÓDIGO	DESCRIPCIÓN	PRECIO	INNER	MASTER
SP1016	Níquel	\$ 48.00	50	500

## Mirilla para puerta principal

Angulo de visión de 180°



CÓDIGO	DESCRIPCIÓN	PRECIO	INNER	MASTER
MIRPD	Dorado	\$ 65.00	25	500
MIRPH	Humo	\$ 65.00	25	500
MIRPS	Cromado	\$ 65.00	25	500

El aspecto, empaque, inner o master de los productos puede variar sin previo aviso debido a la innovación continua de nuestras marcas.

**Tubo para clóset**  
12.5 mm x 25 mm x 3 m  
Espesor 0.8 mm



**Tubo para clóset**  
25 mm x 3 m  
Espesor 0.8 mm



CÓDIGO	DESCRIPCIÓN	PRECIO	INNER	MASTER
TC583	Cromado	\$ 145.00	1	10

CÓDIGO	DESCRIPCIÓN	PRECIO	INNER	MASTER
TC582	Cromado	\$ 135.00	1	10

**Brida para tubo de clóset**  
12.5 mm x 25 mm  
Empaque con 2 piezas



Cuerpo metálico



**Brida para tubo de clóset 25 mm**  
Empaque con 2 piezas



**Soporte para clóset**



Cuerpo metálico



CÓDIGO	DESCRIPCIÓN	PRECIO PAR	INNER	MASTER
BC585	Cromado	\$ 12.00	1 Par	250 Pares

CÓDIGO	DESCRIPCIÓN	PRECIO PAR	INNER	MASTER
BC584	Cromado	\$ 14.00	1 Par	250 Pares

CÓDIGO	DESCRIPCIÓN	PRECIO	INNER	MASTER
SC1015	Metálico/ plateado	\$ 30.00	50	500

**Soporte para clóset**



Cuerpo metálico



**Pericos para puerta con tornillos**  
(50 juegos)



**Cerradura magnética**



CÓDIGO	DESCRIPCIÓN	PRECIO	INNER	MASTER
SC1014	Metálico/ plateado	\$ 18.00	50	500

CÓDIGO	DESC.	PRECIO	INNER	MASTER
PERP50	Acero	\$ 190.00	50	1000
PERP50AB	Humo	\$ 200.00	50	1000

CÓDIGO	DESCRIPCIÓN	PRECIO	INNER	MASTER
CM576	Blanca 42 mm	\$ 6.50	5	500
CM577	Café 42 mm	\$ 6.50	5	500
CM578	Negra 42 mm	\$ 6.50	5	500
CM579	Blanca 58 mm	\$ 12.00	5	500
CM580	Café 58 mm	\$ 12.00	5	500
CM581	Negra 58 mm	\$ 12.00	5	500

## Ganchos



## Ganchos



CÓDIGO	DESCRIPCIÓN	PRECIO	INNER	MASTER
G607C	Cromado	\$ 69.00	25	250
G608N	Níquel pulido	\$ 69.00	25	250

CÓDIGO	DESCRIPCIÓN	PRECIO	INNER	MASTER
G605C	Cromado	\$ 34.00	25	250
G606N	Níquel pulido	\$ 34.00	25	250

## Número de casa 3"

Para exteriores

Fácil de fijar

Resistente a la corrosión

Cuerpo de latón



## Número de casa 6"

Para exteriores

Fácil de fijar

Resistente a la corrosión

Cuerpo de latón



## Número de casa 4"

Para exteriores

Fácil de fijar

Resistente a la corrosión

Cuerpo de acero inoxidable



CÓDIGO	DESCRIPCIÓN	PRECIO	INNER	MASTER
NCB03	No. 0	\$ 65.00	10	200
NCB13	No. 1	\$ 65.00	10	200
NCB23	No. 2	\$ 65.00	10	200
NCB33	No. 3	\$ 65.00	10	200
NCB43	No. 4	\$ 65.00	10	200
NCB53	No. 5	\$ 65.00	10	200
NCB63	No. 6	\$ 65.00	10	200
NCB73	No. 7	\$ 65.00	10	200
NCB83	No. 8	\$ 65.00	10	200
NCB93	No. 9	\$ 65.00	10	200

CÓDIGO	DESCRIPCIÓN	PRECIO	INNER	MASTER
NCB06	No. 0	\$ 156.00	10	200
NCB16	No. 1	\$ 156.00	10	200
NCB26	No. 2	\$ 156.00	10	200
NCB36	No. 3	\$ 156.00	10	200
NCB46	No. 4	\$ 156.00	10	200
NCB56	No. 5	\$ 156.00	10	200
NCB66	No. 6	\$ 156.00	10	200
NCB76	No. 7	\$ 156.00	10	200
NCB86	No. 8	\$ 156.00	10	200
NCB96	No. 9	\$ 156.00	10	200

CÓDIGO	DESCRIPCIÓN	PRECIO	INNER	MASTER
NCA04	No. 0	\$ 85.00	10	200
NCA14	No. 1	\$ 85.00	10	200
NCA24	No. 2	\$ 85.00	10	200
NCA34	No. 3	\$ 85.00	10	200
NCA44	No. 4	\$ 85.00	10	200
NCA54	No. 5	\$ 85.00	10	200
NCA64	No. 6	\$ 85.00	10	200
NCA74	No. 7	\$ 85.00	10	200
NCA84	No. 8	\$ 85.00	10	200
NCA94	No. 9	\$ 85.00	10	200

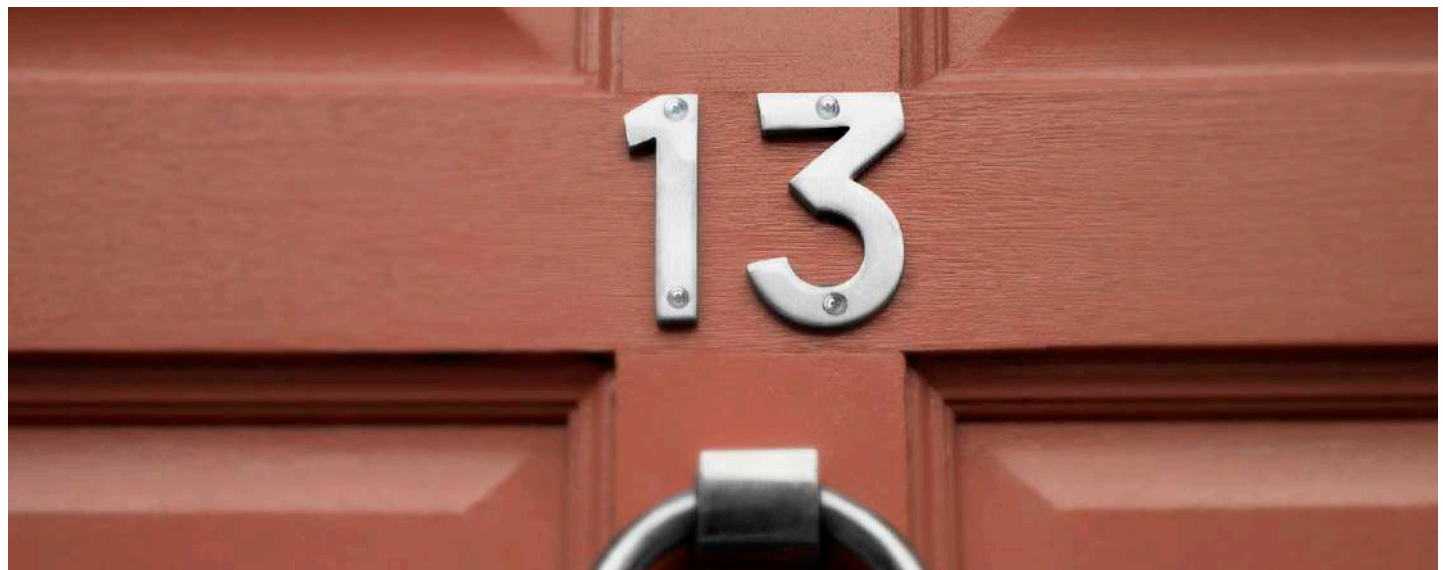



## PATAS PARA MUEBLE

### Pata para mueble

Producto **NUEVO**



CÓDIGO	DESCRIPCIÓN	PRECIO	MASTER
SHPM1998	100 mm	\$ 40.00	100

### Pata para mueble

Producto **NUEVO**

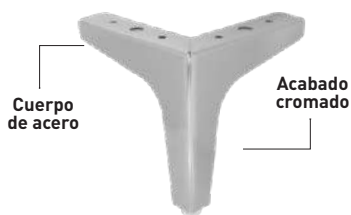

CÓDIGO	DESCRIPCIÓN	PRECIO	MASTER
SHPM1990	130 mm	\$ 70.00	50

### Pata para mueble

Producto **NUEVO**



CÓDIGO	DESCRIPCIÓN	PRECIO	MASTER
SHPM1992	130 mm	\$ 80.00	40

### Pata para mueble

Producto **NUEVO**



CÓDIGO	DESCRIPCIÓN	PRECIO	MASTER
SHPM1997	60 x 60 x 65 mm	\$ 40.00	50

### Pata para mueble

Producto **NUEVO**



CÓDIGO	DESCRIPCIÓN	PRECIO	MASTER
SHPM1996	120 x 120 x 70 mm	\$ 45.00	50

### Pata para mueble

Producto **NUEVO**



CÓDIGO	DESCRIPCIÓN	PRECIO	MASTER
SHPM1991	55 mm	\$ 40.00	60

### Pata para mueble

Producto **NUEVO**



CÓDIGO	DESCRIPCIÓN	PRECIO	MASTER
SHPM1993	190 x 190 mm	\$ 90.00	24

### Pata para mueble

Producto **NUEVO**



CÓDIGO	DESCRIPCIÓN	PRECIO	MASTER
SHPM1999	100 mm	\$ 110.00	40

### Pata para mueble

Producto **NUEVO**



CÓDIGO	DESCRIPCIÓN	PRECIO	MASTER
SHPM1994	40 x 220 mm	\$ 70.00	40

### Pata para mueble

Producto **NUEVO**

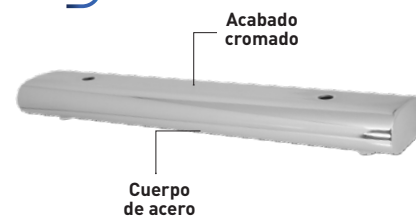

CÓDIGO	DESCRIPCIÓN	PRECIO	MASTER
SHPM1995	20 x 220 mm	\$ 75.00	48

El aspecto, empaque, inner o master de los productos puede variar sin previo aviso debido a la innovación continua de nuestras marcas.

## Pata para mueble

Producto  
**NUEVO**



CÓDIGO	DESCRIPCIÓN	PRECIO	MASTER
SHPM2001	195 x 25 x 35 mm	\$ 28.00	200

## Pata para mueble

Producto  
**NUEVO**



CÓDIGO	DESCRIPCIÓN	PRECIO	MASTER
SHPM2000	140 x 140 x 70 mm	\$ 45.00	140

## Pata para mueble

Producto  
**NUEVO**

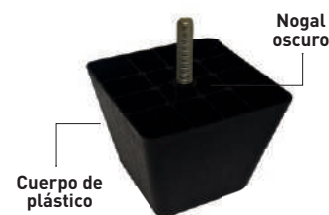

CÓDIGO	DESCRIPCIÓN	PRECIO	MASTER
SHPM2004	96 x 96 mm	\$ 30.00	120

## Pata para mueble

Producto  
**NUEVO**



CÓDIGO	DESCRIPCIÓN	PRECIO	MASTER
SHPM2005	90 x 90 x 107 mm	\$ 40.00	160

## Pata para mueble

Producto  
**NUEVO**



CÓDIGO	DESCRIPCIÓN	PRECIO	MASTER
SHPM2002	178 x 76 x 65 mm	\$ 28.00	120

## Pata para mueble

Producto  
**NUEVO**

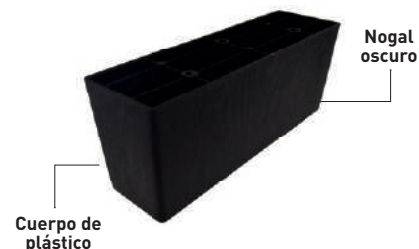

CÓDIGO	DESCRIPCIÓN	PRECIO	MASTER
SHPM2003	180x 70 x 50 mm	\$ 28.00	154

## Pata cuadrada

Producto  
**NUEVO**



CÓDIGO	DESCRIPCIÓN	PRECIO	INN.	MAS.
SHPM1946	38 x 38 x 80 mm	\$ 45.00	20	100
SHPM1947	38 x 38 x 100 mm	\$ 50.00	20	100

## Pata tubular

Producto  
**NUEVO**



CÓDIGO	DESCRIPCIÓN	PRECIO	INN.	MAS.
SHPM1948	38 x 150 mm	\$ 45.00	20	100
SHPM1949	50 x 100 mm	\$ 50.00	20	100

## Pata tubular

Producto  
**NUEVO**



CÓDIGO	DESCRIPCIÓN	PRECIO	INN.	MAS.
SHPM1944	50 x 100 mm	\$ 45.00	20	100
SHPM1945	50 x 120 mm	\$ 50.00	20	100

### Protector para banco 1"



Cuerpo de PVC

Precio por bolsa con 20 piezas

CÓDIGO	PRECIO	INNER	MASTER
PB709	\$ 160.00	20	1000

### Regatón redondo blanco 20 piezas



Cuerpo de caucho

Precio por bolsa

CÓDIGO	DESCRIPCIÓN	PRECIO	INNER	MASTER
SZBS1904	1/2"	\$ 68.00	20	500
SZBS1905	5/8"	\$ 108.00	20	500
SZBS1906	3/4"	\$ 118.00	20	500
SZBS1907	7/8"	\$ 135.00	20	500

### Almohadilla antideslizante negro

Auto-adhesivo



Cuerpo de espuma

SZAE1914: 8 piezas  
SZAE1916: 18 piezas

CÓDIGO	DESCRIPCIÓN	PRECIO	INN.	MAS.
SZAE1914	1 1/2" x 4 mm	\$ 27.00	20	360
SZAE1916	1" x 4 mm	\$ 27.00	20	360

### Almohadilla antideslizante negro

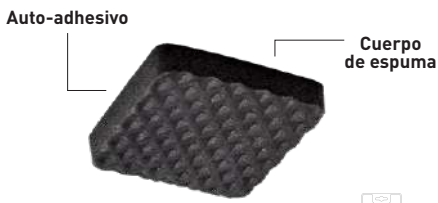

Auto-adhesivo

Cuerpo de espuma

CÓDIGO	DESCRIPCIÓN	PRECIO	INN.	MAS.
SZAE1915	1" x 1" x 4 mm 18 pzas	\$ 27.00	20	360

### Almohadilla de felpa blanco



Auto-adhesivo

Cuerpo de espuma

SZAF1917: 8 piezas  
SZAF1920: 18 piezas

CÓDIGO	DESCRIPCIÓN	PRECIO	INN.	MAS.
SZAF1917	1 1/2" x 4 mm	\$ 27.00	20	360
SZAF1920	1" x 2.5 mm	\$ 32.00	20	360

### Almohadilla de felpa blanco



Auto-adhesivo

Cuerpo de espuma

SZAF1918: 8 piezas  
SZAF1919: 18 piezas

CÓDIGO	DESCRIPCIÓN	PRECIO	INN.	MAS.
SZAF1918	1 1/2" x 1 1/2" x 4 mm	\$ 27.00	20	360
SZAF1919	1" x 1" x 2.5 mm	\$ 32.00	20	360

### Almohadilla de felpa café



Auto-adhesivo

Cuerpo de espuma

SZAF1921: 8 piezas  
SZAF1923: 18 piezas

CÓDIGO	DESCRIPCIÓN	PRECIO	INN.	MAS.
SZAF1921	1 1/2" x 4 mm	\$ 40.00	20	360
SZAF1923	1" x 2.5 mm	\$ 40.00	20	360

### Almohadilla de felpa café



Auto-adhesivo

Cuerpo de espuma

SZAF1922: 8 piezas  
SZAF1924: 18 piezas

CÓDIGO	DESCRIPCIÓN	PRECIO	INN.	MAS.
SZAF1922	1 1/2" x 1 1/2" x 4 mm	\$ 36.00	20	360
SZAF1924	1" x 1" x 2.5 mm	\$ 40.00	20	360

### Almohadilla transparente 16 piezas

Amortiguador para cajones y gabinetes



Auto-adhesivo

CÓDIGO	DESCRIPCIÓN	PRECIO	INN.	MAS.
SZAV1944	3/8" (10 x 2 mm)	\$ 36.00	20	360
SZAV1945	1/2" (12 x 3 mm)	\$ 45.00	20	360

### Almohadilla transparente 8 piezas

Amortiguador para cajones y gabinetes



Auto-adhesivo

CÓDIGO	DESCRIPCIÓN	PRECIO	INN.	MAS.
SZAV1946	1/2" (13 x 3 mm)	\$ 40.00	20	360
SZCE1947	3/8" (10 x 2 mm)	\$ 21.00	20	360
SZCE1948	1/2" (12 x 3 mm)	\$ 22.00	20	360

### Base para mueble café

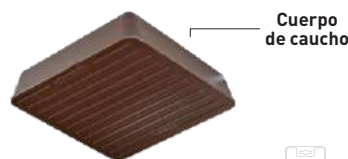

Cuerpo de caucho

CÓDIGO	DESCRIPCIÓN	PRECIO	INN.	MAS.
SZBS1908	1 5/8" 4 pzas	\$ 50.00	6	144
SZBS1909	2" 4 pzas	\$ 68.00	6	144

### Base para mueble café

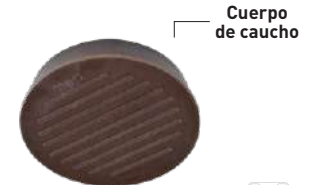

Cuerpo de caucho

CÓDIGO	DESCRIPCIÓN	PRECIO	INN.	MAS.
SZBS1910	1 1/2" 4 pzas	\$ 40.00	6	144
SZBS1911	1 3/4" 4 pzas	\$ 60.00	6	144



## Base para mueble traslúcido 4 piezas



CÓDIGO	DESCRIPCIÓN	PRECIO	INN.	MAS.
SZBS1912	1 3/8"	\$ 40.00	6	144
SZBS1913	1 13/16"	\$ 45.00	6	144

## Base para mueble gris 8 piezas



CÓDIGO	DESC.	PRECIO	INN.	MAS.
SZBM1940	30 mm	\$ 85.00	20	360

## Base para mueble gris 8 piezas



CÓDIGO	DESC.	PRECIO	INN.	MAS.
SZBM1942	25 mm	\$ 95.00	20	360

## Base para mueble gris 8 piezas

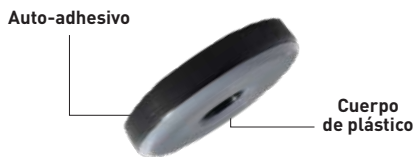

CÓDIGO	DESC.	PRECIO	INN.	MAS.
SZBM1943	38 mm	\$ 170.00	20	360

## Base para mueble café con felpa y clavo



CÓDIGO	DESCRIPCIÓN	PRECIO	INN.	MAS.
SZBM1923	15 mm 40 pzas	\$ 90.00	20	240
SZBM1924	18 mm 30 pzas	\$ 80.00	20	240
SZBM1928	28 mm 14 pzas	\$ 68.00	20	240
SZBM1929	30 mm 10 pzas	\$ 58.00	20	240

## Base para mueble blanco con felpa y clavo



CÓDIGO	DESCRIPCIÓN	PRECIO	INN.	MAS.
SZBM1925	20 mm 24 pzas	\$ 80.00	20	240
SZBM1926	22 mm 20 pzas	\$ 72.00	20	240
SZBM1927	24 mm 16 pzas	\$ 68.00	20	240

## Base para mueble blanco con felpa y tornillo 20 piezas



CÓDIGO	DESCRIPCIÓN	PRECIO	INN.	MAS.
SZBM1930	20 mm	\$ 110.00	20	240

## Base para mueble café con felpa y tornillo



CÓDIGO	DESCRIPCIÓN	PRECIO	INN.	MAS.
SZBM1931	25 mm 10 pzas	\$ 80.00	20	240
SZBM1932	28 mm 8 pzas	\$ 70.00	20	240
SZBM1933	40 mm 4 pzas	\$ 63.00	20	240

## Base para mueble níquel con felpa y tornillo



CÓDIGO	DESCRIPCIÓN	PRECIO	INN.	MAS.
SZBM1934	22 mm 16 pzas	\$ 175.00	20	240
SZBM1935	24 mm 16 pzas	\$ 190.00	20	240
SZBM1936	28 mm 16 pzas	\$ 205.00	20	240

## Base para mueble gris con clavo



CÓDIGO	DESCRIPCIÓN	PRECIO	INN.	MAS.
SZBM1937	19 mm 20 pzas	\$ 175.00	20	360
SZBM1938	22 mm 12 pzas	\$ 125.00	20	360
SZBM1939	26 mm 8 pzas	\$ 130.00	20	360

## Base para mueble gris con clavo



CÓDIGO	DESC.	PRECIO	INN.	MAS.
SZBM1941	22 mm 16 pzas	\$ 170.00	20	360

## Candado cuerpo de latón

Cilindro de latón

Sistema de llave de 6 pernos

Gancho corto de acero templado



Incluye 3 llaves

10 AÑOS De garantía

## Candado cuerpo de latón

Cilindro de latón

Sistema de llave de 6 pernos

Gancho largo de acero templado



Incluye 3 llaves

10 AÑOS De garantía

## Candado cuerpo de latón 2 piezas

Cilindro de latón

Gancho estándar de acero templado



Incluye 3 llaves

10 AÑOS De garantía

Producto **NUEVO**



Producto **NUEVO**



Producto **NUEVO**



CÓDIGO	DESCRIPCIÓN	PRECIO	INNER	MASTER
SHC1987	40 mm	\$ 100.00	6	72
SHC1988	50 mm	\$ 165.00	6	36

CÓDIGO	DESCRIPCIÓN	PRECIO	INNER	MASTER
SHC1989L	40 mm	\$ 105.00	6	72
SHC1990L	50 mm	\$ 165.00	6	36

CÓDIGO	DESCRIPCIÓN	PRECIO	INNER	MASTER
SHC1986	40 mm	\$ 200.00	6	36

## Candado cuerpo de hierro

Cilindro de latón

Seguro tipo perno

Gancho corto de acero templado



Incluye 3 llaves

5 AÑOS De garantía

## Candado cuerpo de hierro

Cilindro de latón

Seguro tipo perno

Gancho largo de acero templado



Incluye 3 llaves

5 AÑOS De garantía



Caja a color



Caja a color

CÓDIGO	DESCRIPCIÓN	PRECIO	INNER	MASTER
C3020	20 mm	\$ 22.00	12	480
C3025	25 mm	\$ 27.00	12	360
C3032	32 mm	\$ 32.00	6	180
C3038	38 mm	\$ 40.00	6	120
C3050	63 mm	\$ 63.00	6	60

CÓDIGO	DESCRIPCIÓN	PRECIO	INNER	MASTER
C3525	25 mm	\$ 25.00	12	360
C3532	32 mm	\$ 35.00	12	180
C3538	38 mm	\$ 42.00	6	120
C3550	50 mm	\$ 73.00	6	60

## Candado cuerpo de hierro

Cilindro de latón

Gancho de acero templado



Incluye 3 llaves

5 AÑOS De garantía

## Candado cromo satinado

Cilindro de latón

Gancho de acero templado



Incluye 3 llaves

5 AÑOS De garantía



Caja a color



Blister Doble

CÓDIGO	DESCRIPCIÓN	PRECIO	INNER	MASTER
CHL1183	40 mm	\$ 52.00	6	180
CHL1184	50 mm	\$ 80.00	6	120
CHL1185	40 mm largo	\$ 55.00	6	60
CHL1186	50 mm largo	\$ 86.00	6	36

CÓDIGO	DESCRIPCIÓN	PRECIO	INNER	MASTER
CFF32	32 mm	\$ 48.00	6	180
CFF38	38 mm	\$ 65.00	6	120
CFF50	50 mm	\$ 80.00	6	60
CFF63	63 mm	\$ 100.00	6	36

## Candado cuerpo metálico gancho corto

Cilindro de latón

Gancho de acero templado



Incluye 3 llaves

5 AÑOS De garantía



Caja a color

CÓDIGO	DESCRIPCIÓN	PRECIO	INNER	MASTER
CM1700	26 mm	\$ 51.00	6	24
CM1701	38 mm	\$ 99.00	6	24
CM1702	45 mm	\$ 149.00	6	24
CM1703	50 mm	\$ 180.00	6	24

## Candado cuerpo metálico gancho largo

Cilindro de latón

Gancho de acero templado



Incluye 3 llaves

5 AÑOS De garantía



Caja a color

CÓDIGO	DESCRIPCIÓN	PRECIO	INNER	MASTER
CM1704	26 mm	\$ 53.00	6	24
CM1705	38 mm	\$ 108.00	6	24
CM1706	45 mm	\$ 162.00	6	24
CM1707	50 mm	\$ 189.00	6	24

## Candado laminado

Cilindro de latón

Gancho corto de acero templado

Sistema de llave 4 pernos



Incluye 2 llaves

5 AÑOS De garantía



Blister

CÓDIGO	DESCRIPCIÓN	PRECIO	INNER	MASTER
CL7130	30 mm	\$ 45.00	1	24
CL7140	40 mm	\$ 57.00	1	12
CL7150	50 mm	\$ 80.00	1	12

## Candado laminado

Cilindro de latón

Gancho largo de acero templado

Sistema de llave 4 pernos

Cuerpo de hierro



Incluye 2 llaves

5 AÑOS De garantía



Blister

CÓDIGO	DESCRIPCIÓN	PRECIO	INNER	MASTER
CL7130L	30 mm	\$ 55.00	24	192
CL7140L	40 mm	\$ 70.00	12	96
CL7150L	50 mm	\$ 90.00	12	48

## Candado laminado 40 mm

Cilindro de latón

Gancho de acero templado

Sistema de llave 5 pernos



Incluye 2 llaves

5 AÑOS De garantía



Blister Doble

CÓDIGO	DESCRIPCIÓN	PRECIO	INNER	MASTER
CL27140	2 pzas.	\$ 130.00	6	48
CL47140	4 pzas.	\$ 250.00	6	24

## Candado de combinación laminado

5 AÑOS De garantía



Blister

CÓDIGO	PRECIO	INNER	MASTER
CC2050	\$ 70.00	6	72

## Candado de hierro con coraza alta seguridad

Cilindro de latón



## Candado cuerpo de acero

Cilindro de latón

Gancho de acero templado

Alta seguridad



CÓDIGO	DESCRIPCIÓN	PRECIO	INNER	MASTER
C6540	40 mm	\$ 85.00	12	96
C6550	50 mm	\$ 115.00	12	72
C6560	60 mm	\$ 135.00	12	72

CÓDIGO	DESCRIPCIÓN	PRECIO	INNER	MASTER
C6140	40 mm	\$ 85.00	12	96
C6150	50 mm	\$ 100.00	12	72
C6160	60 mm	\$ 125.00	12	72
C6170	70 mm	\$ 170.00	12	72

## Candado cuerpo de hierro antipalanca 70 mm

Cilindro de latón

Para cortina

Alta seguridad



## Candado cuerpo de acero máxima seguridad

Cilindro de latón

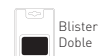

CÓDIGO	PRECIO	INNER	MASTER
C9070	\$ 145.00	4	40

CÓDIGO	DESCRIPCIÓN	PRECIO	INNER	MASTER
C5065	Gancho corto 65 mm	\$ 230.00	6	24
C5065L	Gancho largo 65 mm	\$ 250.00	6	24

## Candado cuerpo de latón antipalanca

Cilindro de latón

Para cortina

Alta seguridad



## Candado cuerpo de acero alta seguridad con forro gancho protegido

Cilindro de latón

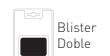

CÓDIGO	DESCRIPCIÓN	PRECIO	INNER	MASTER
C8565	65 mm	\$ 350.00	6	60
C8575	75 mm	\$ 450.00	6	40

CÓDIGO	DESCRIPCIÓN	PRECIO	INNER	MASTER
C4555	55 mm	\$ 210.00	6	60
C4565	65 mm	\$ 260.00	6	36

El aspecto, empaque, inner o master de los productos puede variar sin previo aviso debido a la innovación continua de nuestras marcas.

# CANDADOS



**Candado de combinación maletero**  
3 dígitos  
combinación personalizable



Cuerpo metálico



Blister doble

CÓDIGO	PRECIO	INNER	MASTER
C5500	\$ 40.00	12	360

**Candado para bicicleta combinación**  
Espesor: 10 mm



Cable de acero



Tarjeta

CÓDIGO	DESCRIPCIÓN	PRECIO	INNER	MASTER
CBC1065CM	65 cm	\$ 80.00	12	120

**Candado para bicicleta combinación**  
Espesor: 6 mm

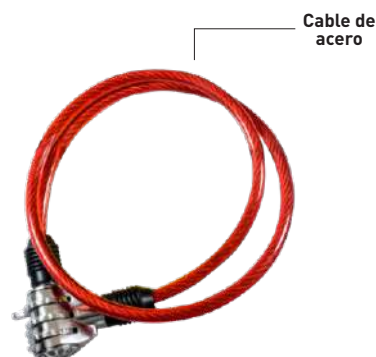

Cable de acero



Tarjeta

CÓDIGO	DESCRIPCIÓN	PRECIO	INNER	MASTER
CBC665CM	65 cm	\$ 55.00	12	120

**Candado cable multiusos**

Cable de acero



Incluye 2 llaves



Tarjeta

CÓDIGO	DESCRIPCIÓN	PRECIO	INNER	MASTER
CC60CM	60 cm	\$ 50.00	12	120

**Candado cable con llave**

Cable de acero



Incluye 2 llaves



Tarjeta

CÓDIGO	DESCRIPCIÓN	PRECIO	INNER	MASTER
CCL1118	1 m	\$ 115.00	12	48

**Candado cable de combinación**

Cable de acero



Tarjeta

CÓDIGO	DESCRIPCIÓN	PRECIO	INNER	MASTER
CCC1121	1.2 m	\$ 135.00	12	48

**Candado cable espiral**

Cable de acero



Incluye 2 llaves



Tarjeta

CÓDIGO	DESCRIPCIÓN	PRECIO	INNER	MASTER
CC100CM	1 m	\$ 55.00	12	120



CANDADOS

El aspecto, empaque, inner o master de los productos puede variar sin previo aviso debido a la innovación continua de nuestras marcas.

## Botón

Diámetro: 29.40 mm



B244AH



B244BH



CÓDIGO	DESCRIPCIÓN	PRECIO	INNER	MASTER
B244AH	Almendra humo	\$ 14.00	50	500
B244BH	Blanco humo	\$ 14.00	50	500

## Botón

Diámetro: 29.40 mm



B244MD



B244BD



B244AD



CÓDIGO	DESCRIPCIÓN	PRECIO	INNER	MASTER
B244MD	Madera dorado	\$ 16.00	50	500
B244BD	Blanco dorado	\$ 15.00	50	500
B244AD	Almendra dorado	\$ 15.00	50	500

## Botón

Diámetro: 28.60 mm



B752D



B753N



CÓDIGO	DESCRIPCIÓN	PRECIO	INNER	MASTER
B752D	Dorado	\$ 9.00	100	1000
B753N	Níquel	\$ 9.50	100	1000

## Botón



B344N



B344H



B344D



CÓDIGO	DESCRIPCIÓN	PRECIO	INNER	MASTER
B344N	Níquel 28.60 mm	\$ 16.00	50	500
B344H	Humo 30.80 mm	\$ 15.00	50	500
B344D	Dorado 28.60 mm	\$ 15.00	50	500

## Botón

Diámetro: 28.70 mm



B751N



B328



B750D



CÓDIGO	DESCRIPCIÓN	PRECIO	INNER	MASTER
B751N	Níquel	\$ 9.00	100	1000
B328	Satinado	\$ 13.00	50	500
B750D	Dorado	\$ 8.50	100	1000

## Botón



B114D



B110H



CÓDIGO	DESCRIPCIÓN	PRECIO	INNER	MASTER
B114D	Dorado 29.40 mm	\$ 10.50	50	500
B110H	Humo 28.60 mm	\$ 10.50	50	500

## Botón

Diámetro: 35.50 mm



B748D



B749H



CÓDIGO	DESCRIPCIÓN	PRECIO	INNER	MASTER
B748D	Dorado	\$ 13.00	80	800
B749H	Humo	\$ 13.00	100	1000

## Botón

Diámetro: 28.60 mm



B745N



B746H



B746D



CÓDIGO	DESCRIPCIÓN	PRECIO	INNER	MASTER
B745N	Níquel	\$ 9.50	100	1000
B746H	Humo	\$ 9.00	100	1000
B746D	Dorado	\$ 9.00	100	1000

## Botón



B6144BN

B6144D

CÓDIGO	DIÁMETRO	PRECIO	INNER	MASTER
B6144BN	27.60 mm	\$ 20.00	50	8 00
B6144D	35.50 mm	\$ 20.00	50	800

## Botón dorado solido



CÓDIGO	DIÁMETRO	PRECIO	INNER	MASTER
B802D	16.60 mm	\$34.00	50	500

## Botón níquel



CÓDIGO	DIÁMETRO	PRECIO	INNER	MASTER
B405N	32.80 mm	\$13.00	50	500

## Botón níquel



CÓDIGO	DIÁMETRO	PRECIO	INNER	MASTER
B401N	31.80 mm	\$14.00	50	500

## Botón humo



CÓDIGO	DIÁMETRO	PRECIO	INNER	MASTER
B1265H	31.80 mm	\$ 14.00	100	1000
B406S	31.80 mm	\$ 16.00	50	500

## Botón níquel



CÓDIGO	DIÁMETRO	PRECIO	INNER	MASTER
B505BN	28.20 mm	\$ 14.00	100	1000

## Botón níquel



CÓDIGO	DIÁMETRO	PRECIO	INNER	MASTER
B647N	30.50 mm	\$ 12.00	50	500

## Botón níquel



CÓDIGO	DIÁMETRO	PRECIO	INNER	MASTER
B270N	18.50 mm	\$ 18.00	100	1000

## Botón níquel



CÓDIGO	DIÁMETRO	PRECIO	INNER	MASTER
B391N	27.60 mm	\$ 29.00	50	500

## Botón níquel cuadrado



CÓDIGO	DESCRIPCIÓN	PRECIO	INNER	MASTER
B723N	20 x 20 mm	\$ 17.00	80	800
B724N	40 x 40 mm	\$ 28.00	50	500
B725N	60 x 60 mm	\$ 42.00	20	200

## Botón níquel sólido 1 1/4"



CÓDIGO	DESCRIPCIÓN	PRECIO	INNER	MASTER
B600N	30 x 30 mm	\$ 31.00	50	500

## Botón níquel 2 3/4"



CÓDIGO	DESCRIPCIÓN	PRECIO	INNER	MASTER
B500N	70 x 70 mm	\$ 50.00	20	200

El aspecto, empaque, inner o master de los productos puede variar sin previo aviso debido a la innovación continua de nuestras marcas.

**Botón níquel**

CÓDIGO	DESCRIPCIÓN	PRECIO	INNER	MASTER
B1023N	30 x 30 mm	\$ 13.00	100	1000

**Botón níquel**

CÓDIGO	DIÁMETRO	PRECIO	INNER	MASTER
B408N	25 mm	\$ 27.00	50	500

**Botón níquel**

CÓDIGO	DIÁMETRO	PRECIO	INNER	MASTER
B633N	20 mm	\$ 21.00	50	1000

**Botón níquel**

CÓDIGO	DIÁMETRO	PRECIO	INN.	MAS.
B631N	13 mm	\$ 15.00	100	1000
B632N	20 mm	\$ 20.00	50	1000

**Botón níquel**

CÓDIGO	DIÁMETRO	PRECIO	INNER	MASTER
B407N	29.70 mm	\$ 25.00	50	500

**Botón infantil soccer 1 1/2"**

Producto sujeto a disponibilidad\*

CÓDIGO	DIÁMETRO	PRECIO	INNER	MASTER
BI428	40 mm	\$ 29.00	50	500

**Botón infantil Minnie 2" x 1 1/2"**

Producto sujeto a disponibilidad\*

CÓDIGO	DESCRIPCIÓN	PRECIO	INNER	MASTER
BI429	40 x 50 mm	\$ 26.50	50	500

**Botón infantil Mickey 1 1/4"**

Producto sujeto a disponibilidad\*

CÓDIGO	DESCRIPCIÓN	PRECIO	INNER	MASTER
BI430	35 x 50 mm	\$ 26.50	50	500

**Botón infantil Cars 1 1/2"**

Producto sujeto a disponibilidad\*

CÓDIGO	DIÁMETRO	PRECIO	INNER	MASTER
BI427	40 mm	\$ 26.50	50	500





## Perfiles de jaladeras de aluminio

3 m de largo

Cuerpo de aluminio

Producto **NUEVO**

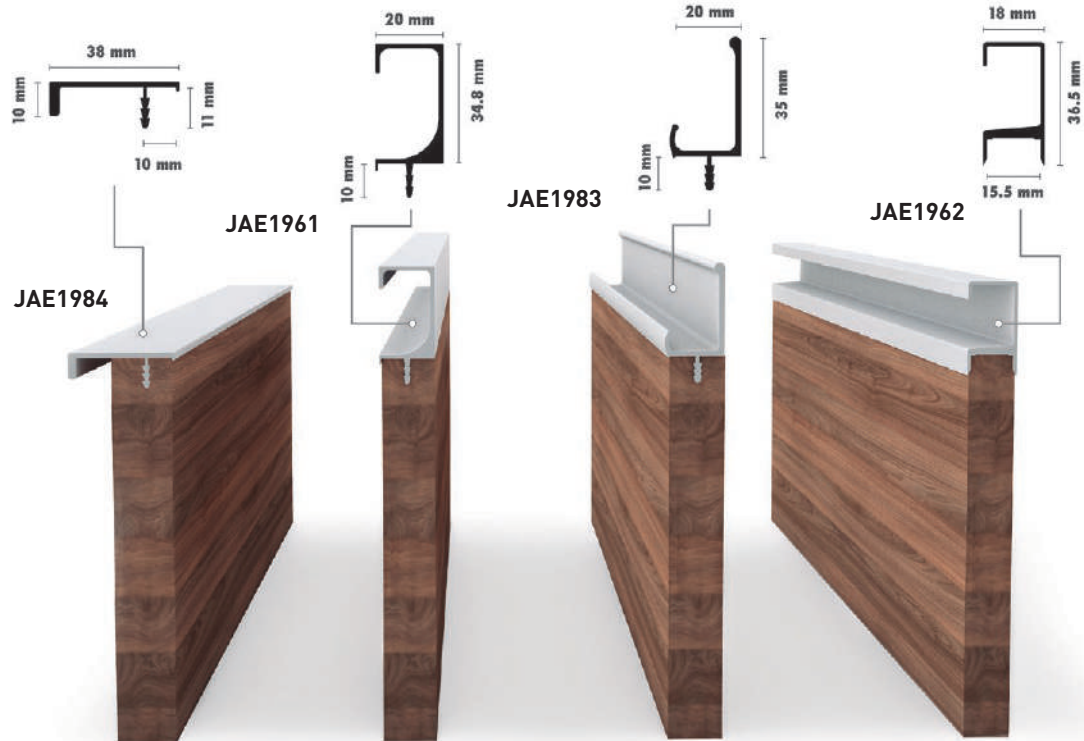

CÓDIGO	DESCRIPCIÓN	PRECIO	INNER	MASTER
JAE1961	Perfil tipo C	\$ 380.00	1	10
JAE1984	Perfil tipo Recto	\$ 320.00	1	10

CÓDIGO	DESCRIPCIÓN	PRECIO	INNER	MASTER
JAE1983	Perfil tipo J	\$ 530.00	1	10
JAE1962	Perfil tipo C sin inserto	\$ 400.00	1	10

## Jaladera níquel

Alto: 13 mm

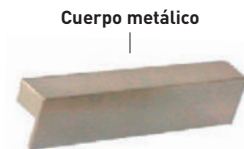

CÓDIGO	LARGO	PRECIO	INNER	MASTER
J611N	64 mm	\$ 42.00	40	400
J612N	96 mm	\$ 49.00	25	250
J613N	128 mm	\$ 63.00	20	200
J614N	160 mm	\$ 85.00	20	200
J615N	192 mm	\$ 105.00	20	200
J617N	256 mm	\$ 124.00	10	100

## Jaladera aluminio

Alto: 14 mm



CÓDIGO	LARGO	PRECIO	INNER	MASTER
JA1004	96 x 208 mm	\$ 50.00	10	100
JA1005	128 x 240 mm	\$ 69.00	10	100
JA1006	192 x 304 mm	\$ 70.00	10	100
JA1007	256 x 368 mm	\$ 80.00	10	100
JA1008	320 x 432 mm	\$ 90.00	10	100

## Jaladera níquel

Ancho: 13 mm



CÓDIGO	Largo	PRECIO	INNER	MASTER
J739N	96 mm	\$ 20.00	100	1000
J740N	128 mm	\$ 23.00	50	500
J741N	160 mm	\$ 28.00	50	500

## Jaladera níquel

Diámetro 25 mm



CÓDIGO	Largo	PRECIO	INNER	MASTER
J1241N	156 mm	\$ 73.00	15	150
J1242N	256 mm	\$ 81.00	10	100
J1243N	632 mm	\$ 135.00	10	100



## Jaladera aluminio cromada

Ancho: 34.40 mm



CÓDIGO	Largo	PRECIO	INNER	MASTER
JA1009C	160 mm	\$ 210.00	20	100
JA1010C	256 mm	\$ 230.00	20	80

El aspecto, empaque, inner o master de los productos puede variar sin previo aviso debido a la innovación continua de nuestras marcas.

## Jaladera níquel hueca

Alto: 25 mm

Producto **NUEVO**

Cuerpo metálico



CÓDIGO	LARGO	PRECIO	INNER	MASTER
JH1950	140 mm	\$ 45.00	25	250

## Jaladera níquel solida

Alto: 25 mm

Cuerpo metálico



CÓDIGO	LARGO	PRECIO	INNER	MASTER
J1012N	140 mm	\$ 65.00	10	100

## Jaladera níquel solida

Cuerpo metálico



CÓDIGO	DESCRIPCIÓN	PRECIO	INNER	MASTER
J1013N	70 x 70 mm	\$ 28.00	10	100

## Jaladera níquel solida

Ancho: 25 mm



CÓDIGO	LARGO	PRECIO	INN.	MAS.
J1011N	128 mm	\$ 59.00	10	100

## Jaladera níquel



CÓDIGO	PRECIO	INNER	MASTER
J1245N	\$ 18.00	100	1000

## Jaladera

Cuerpo de aluminio

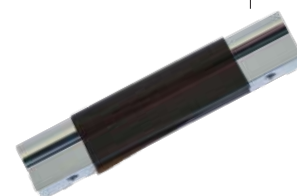

## Jaladera de empotrar níquel

Ancho: 30 mm



CÓDIGO	LARGO	PRECIO	INNER	MASTER
JE96N	96 mm	\$ 44.00	50	500
JE128N	128 mm	\$ 50.00	30	300
JE160N	160 mm	\$ 60.00	25	250

## Jaladera níquel

Ancho: 42.80 mm



CÓDIGO	LARGO	PRECIO	INNER	MASTER
J1244N	33 mm	\$ 30.00	50	500

CÓDIGO	LARGO	PRECIO	INNER	MASTER
J1254A	32 mm	\$ 15.00	50	500
J1255A	64 mm	\$ 18.00	50	500
J1256A	96 mm	\$ 24.00	50	500
J1257A	128 mm	\$ 29.00	50	500
J1258A	160 mm	\$ 35.00	50	500
J1259A	192 mm	\$ 44.00	20	200
J1260A	224 mm	\$ 53.00	20	200
J1261A	288 mm	\$ 62.00	20	200

## Jaladera

Producto **NUEVO**



Acero



CÓDIGO	DESCRIPCIÓN	PRECIO	INNER	MASTER
J1951A	96 mm	\$ 28.00	20	200
J1952A	128 mm	\$ 34.00	20	200
J1953A	160 mm	\$ 40.00	20	200

## Jaladera níquel



CÓDIGO	Largo	PRECIO	INNER	MASTER
J742N	96 mm	\$ 26.00	50	500
J743N	128 mm	\$ 32.00	50	500
J744N	160 mm	\$ 36.00	25	250

## Jaladera níquel

Ancho: 17 mm



CÓDIGO	Largo	PRECIO	INNER	MASTER
J735N	70 mm	\$ 20.00	50	500
J736N	100 mm	\$ 23.00	40	400
J737N	130 mm	\$ 32.00	30	300
J738N	160 mm	\$ 37.00	30	300

## Jaladera níquel hueca

Diámetro: 10.5 mm

Cuerpo de acero inoxidable



CÓDIGO	Largo	PRECIO	INNER	MASTER
J754N	96 mm	\$ 46.00	20	200
J755N	128 mm	\$ 50.00	20	200
J756N	160 mm	\$ 52.00	25	100
J757N	192 mm	\$ 58.00	25	100
J758N	224 mm	\$ 60.00	25	100

## Jaladera níquel sólida

Diámetro: 11 mm

Cuerpo de acero inoxidable



CÓDIGO	Largo	PRECIO	INNER	MASTER
J759N	256 mm	\$ 66.00	25	100
J1440N	288 mm	\$ 74.00	10	100
J1441N	320 mm	\$ 80.00	5	50
J1442N	384 mm	\$ 90.00	8	40
J1443N	480 mm	\$ 104.00	10	100

CÓDIGO	Largo	PRECIO	INNER	MASTER
J1444N	500 mm	\$ 110.00	8	40
J1445N	600 mm	\$ 140.00	8	40
J1446N	700 mm	\$ 155.00	8	40
J1447N	800 mm	\$ 179.00	8	40
J1448N	900 mm	\$ 198.00	8	40

## Jaladera níquel

Ancho: 25 mm

Cuerpo metálico



CÓDIGO	Largo	PRECIO	INNER	MASTER
J621N	96 mm	\$ 25.00	40	400
J622N	128 mm	\$ 28.00	40	400
J623N	160 mm	\$ 33.00	40	400
J624N	224 mm	\$ 53.00	25	250
J625N	288 mm	\$ 75.00	25	200

## Jaladera tubular hueca de acero inoxidable

Diámetro: 12 mm



CÓDIGO	DESCRIPCIÓN	PRECIO	INNER	MASTER
JTH898	76 x 136 mm	\$ 16.00	50	400
JTH899	96 x 150 mm	\$ 17.00	50	300
JTH900	128 x 188 mm	\$ 19.00	50	300
JTH901	160 x 230 mm	\$ 21.00	50	300

## Jaladera tubular sólida de acero

Diámetro: 12 mm



CÓDIGO	DESCRIPCIÓN	PRECIO	INN.	MAS.
JT76136	76 x 136 mm	\$ 25.00	25	200
JT96150	96 x 150 mm	\$ 27.00	25	100
JT128188	128 x 188 mm	\$ 29.00	25	100
JT160230	160 x 230 mm	\$ 32.00	25	100
JT277337	277 x 337 mm	\$ 46.00	25	100
JT450510	450 x 510 mm	\$ 82.00	10	50
JT477537	477 x 537 mm	\$ 88.00	10	50
JT595655	595 x 655 mm	\$ 110.00	10	50
JT860920	860 x 920 mm	\$ 150.00	10	50

## Jaladera níquel

Ancho: 13 mm

Cuerpo metálico



CÓDIGO	Largo	PRECIO	INNER	MASTER
J601N	96 mm	\$ 45.00	40	400
J602N	128 mm	\$ 55.00	50	200
J603N	160 mm	\$ 65.00	25	300
J604N	192 mm	\$ 75.00	20	200
J606N	256 mm	\$ 125.00	10	100
J608N	320 mm	\$ 170.00	25	250

## Jaladera níquel

Ancho: 9 mm

Cuerpo metálico



CÓDIGO	Largo	PRECIO	INNER	MASTER
J1017N	96 mm	\$ 34.00	50	500
J1018N	128 mm	\$ 38.00	50	500
J1019N	160 mm	\$ 48.00	40	400
J1426N	192 mm	\$ 80.00	30	300
J1020N	224 mm	\$ 92.00	30	300

## Jaladera níquel

Ancho: 8 mm

Cuerpo metálico



CÓDIGO	Largo	PRECIO	INNER	MASTER
J1970N	128 mm	\$ 50.00	50	500
J1971N	192 mm	\$ 70.00	50	500
J1972N	256 mm	\$ 100.00	50	500

## Jaladera níquel

Ancho: 25 mm



CÓDIGO	LARGO	PRECIO	INN.	MAS.
J1250N	96 mm	\$ 52.00	50	500
J1251N	128 mm	\$ 72.00	35	350

## Jaladera, acero inoxidable (304)

Ancho: 36.30 mm



CÓDIGO	Largo	PRECIO	INNER	MASTER
J1000A	96 mm	\$ 62.00	30	300
J1432A	128 mm	\$ 63.00	25	250
J1433A	160 mm	\$ 72.00	25	250
J1001A	192 mm	\$ 76.00	25	250
J1002A	256 mm	\$ 82.00	20	200
J1003A	320 mm	\$ 90.00	20	200

## Jaladera níquel 64 mm



CÓDIGO	LARGO	PRECIO	INNER	MASTER
J1246N	32 mm	\$ 24.00	60	600

## Jaladera tipo arco

Producto NUEVO



Color negro



CÓDIGO	DESCRIPCIÓN	PRECIO	INNER	MASTER
JN1950	150 mm	\$ 27.00	20	200

## Jaladera curva satín

Diámetro: 9.5 mm



CÓDIGO	Largo	PRECIO	INNER	MASTER
J3770S	100 mm	\$ 21.00	50	600
J3755S	130 mm	\$ 24.00	80	800

## Jaladera curva acero

Diámetro: 9.5 mm



CÓDIGO	Largo	PRECIO	INNER	MASTER
JC10	100 mm	\$ 23.00	30	300
JC13	130 mm	\$ 26.00	30	300
JC17	170 mm	\$ 30.00	20	200
JC20	200 mm	\$ 35.00	24	120

## Jaladera plata



CÓDIGO	Largo	PRECIO	INNER	MASTER
J1268P	96 mm	\$ 17.00	40	800

## Jaladera níquel



CÓDIGO	Largo	PRECIO	INNER	MASTER
J652N	100 mm	\$ 18.00	50	500
J651N	140 mm	\$ 20.00	50	500

## Jaladera níquel



CÓDIGO	Largo	PRECIO	INNER	MASTER
J355N	94 mm	\$ 20.00	50	500

## Jaladera níquel



CÓDIGO	Largo	PRECIO	INNER	MASTER
J641N	96 mm	\$ 25.00	50	500
J642N	128 mm	\$ 32.00	50	500
J643N	160 mm	\$ 37.00	50	500

## Jaladera níquel



CÓDIGO	Largo	PRECIO	INNER	MASTER
J732N	96 mm	\$ 19.00	100	1000

## Jaladera cromada



CÓDIGO	Largo	PRECIO	INNER	MASTER
J998C	160 mm	\$ 70.00	40	200
J999C	320 mm	\$ 130.00	25	125

## Jaladera níquel



CÓDIGO	Largo	PRECIO	INNER	MASTER
J501N	96 mm	\$ 26.00	50	500
J504N	128 mm	\$ 33.00	40	400
J503N	160 mm	\$ 47.00	30	300

## Jaladera níquel



CÓDIGO	Largo	PRECIO	INNER	MASTER
J733N	96 mm	\$ 20.00	60	600

## Jaladera níquel



CÓDIGO	Largo	PRECIO	INNER	MASTER
J527N	92 mm	\$ 28.00	50	500

El aspecto, empaque, inner o master de los productos puede variar sin previo aviso debido a la innovación continua de nuestras marcas.

## Jaladera

Largo: 93 mm

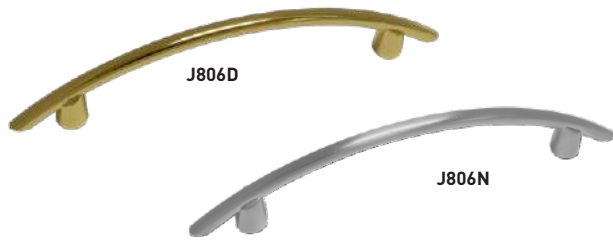

CÓDIGO	DESCRIPCIÓN	PRECIO	INNER	MASTER
J806D	Dorado	\$ 17.00	50	500
J806N	Níquel	\$ 17.50	50	500

## Jaladera

Largo: 96 mm



CÓDIGO	DESCRIPCIÓN	PRECIO	INNER	MASTER
J734D	Dorado	\$ 17.00	80	800
J734N	Níquel	\$ 18.00	80	800

## Jaladera clásica

Largo: 72 mm

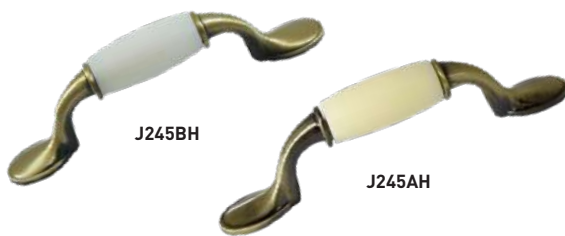

CÓDIGO	DESC.	PRECIO	INN.	MAS.
J245BH	Blanco humo	\$ 24.00	50	500
J245AH	Almendra humo	\$ 24.00	50	500



CÓDIGO	DESC.	PRECIO	INN.	MAS.
J245BD	Blanco dorado	\$ 24.00	50	500
J245AD	Almendra dorado	\$ 24.00	50	500
J245MD	Madera dorado	\$ 27.00	50	500

## Jaladera

Largo: 76 mm



CÓDIGO	DESCRIPCIÓN	PRECIO	INNER	MASTER
J727D	Dorado	\$ 20.00	50	500
J728N	Níquel	\$ 22.00	50	500

## Jaladera

Largo: 76 mm

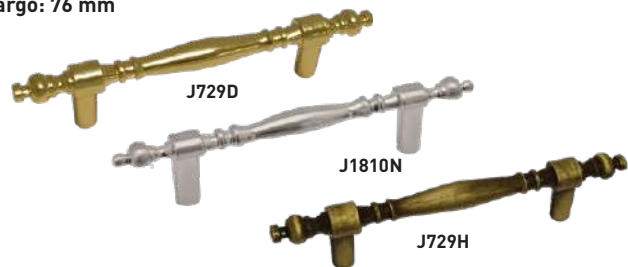

CÓDIGO	DESCRIPCIÓN	PRECIO	INNER	MASTER
J729D	Dorado	\$ 21.00	75	750
J1810N	Níquel	\$ 21.00	75	750
J729H	Humo	\$ 20.00	75	750

## Jaladera

Largo: 74.50 mm



CÓDIGO	DESCRIPCIÓN	PRECIO	INNER	MASTER
J320D	Dorado	\$ 20.00	50	500
J320H	Humo	\$ 20.00	50	500
J320N	Níquel	\$ 20.00	50	500

## Jaladera

Largo: 74.50 mm

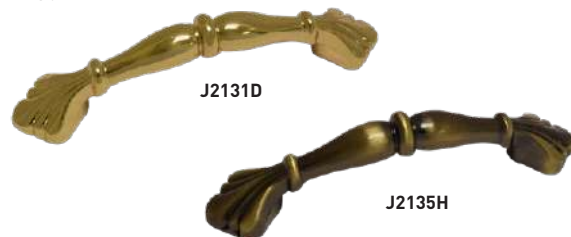

CÓDIGO	DESCRIPCIÓN	PRECIO	INNER	MASTER
J2131D	Dorado	\$ 19.50	40	400
J2135H	Humo	\$ 19.50	40	400

## Jaladera níquel

Ancho: 96 mm



CÓDIGO	Largo	PRECIO	INNER	MASTER
J1969N	96 mm	\$ 18.00	50	500

## Jaladera níquel

Ancho: 25 mm



CÓDIGO	LARGO	PRECIO	INNER	MASTER
J1247N	96 mm	\$ 28.00	50	500
J1248N	128 mm	\$ 33.00	20	200
J1249N	160 mm	\$ 41.00	20	200

## Jaladera níquel



CÓDIGO	Largo	PRECIO	INNER	MASTER
J502N	99.40 mm	\$ 20.00	50	500

## Jaladera níquel



CÓDIGO	Largo	PRECIO	INNER	MASTER
J4333	99.40 mm	\$ 26.00	40	400

## Jaladera níquel



CÓDIGO	Largo	PRECIO	INNER	MASTER
J365N	99.40 mm	\$ 30.00	20	200

## Jaladera níquel



CÓDIGO	Largo	PRECIO	INNER	MASTER
J1267N	78 mm	\$ 20.00	50	500

## Jaladera dorada



CÓDIGO	Largo	PRECIO	INNER	MASTER
J14D	73.30 mm	\$ 19.00	40	400

## Jaladera níquel



CÓDIGO	Largo	PRECIO	INNER	MASTER
J1266N	78 mm	\$ 20.00	50	500

## Jaladera dorada



CÓDIGO	Largo	PRECIO	INN.	MAS.
J730D	76 mm	\$ 21.00	50	500

## Jaladera dorada



CÓDIGO	Largo	PRECIO	INN.	MAS.
J731D	76 mm	\$ 21.00	50	500

## Jaladera humo



CÓDIGO	Largo	PRECIO	INN.	MAS.
J726H	76 mm	\$ 20.00	50	500

El aspecto, empaque, inner o master de los productos puede variar sin previo aviso debido a la innovación continua de nuestras marcas.

## Jaladera humo

Largo: 140 mm



CÓDIGO	PRECIO	INNER	MASTER
J1269H	\$ 20.00	50	500

## Jaladera negra



CÓDIGO	LARGO	PRECIO	INNER	MASTER
J1262ND	140 mm	\$ 22.00	50	500

## Jaladera

Largo: 60 mm



J104D



J100H



J108N



CÓDIGO	DESCRIPCIÓN	PRECIO	INNER	MASTER
J104D	Dorado	\$ 25.00	25	250
J100H	Humo	\$ 25.00	25	250
J108N	Níquel	\$ 25.00	25	250

## Jaladera

Largo: 75 mm



J24D



J24H



CÓDIGO	DESCRIPCIÓN	PRECIO	INNER	MASTER
J24D	Dorado	\$ 20.00	25	250
J24H	Humo	\$ 20.00	25	250

## Jaladera humo



CÓDIGO	LARGO	PRECIO	INNER	MASTER
J1270H	110 mm	\$ 30.00	40	400

## Jaladera negra



CÓDIGO	LARGO	PRECIO	INNER	MASTER
J1263ND	120 mm	\$ 46.00	25	250

## Jaladera vampiro

Largo: 75 mm



J380D



J380H



CÓDIGO	DESCRIPCIÓN	PRECIO	INNER	MASTER
J380D	Dorado	\$ 18.50	25	250
J380H	Humo	\$ 18.50	20	200



## Jaladera

Largo: 75 mm



J204D



J200H



CÓDIGO	DESCRIPCIÓN	PRECIO	INNER	MASTER
J204D	Dorado	\$ 30.00	25	250
J200H	Humo	\$ 30.00	25	250

El aspecto, empaque, inner o master de los productos puede variar sin previo aviso debido a la innovación continua de nuestras marcas.

# Bisagras BIDIMENSIONALES

PARA GABINETES



**OCULTAS**  
INVISIBLES DESDE FUERA DEL MUEBLE



**CIERRE AUTOMÁTICO**  
A PARTIR DE CIERTO ÁNGULO



**AJUSTABLES**  
DISTANCIA REGULABLE

## Bisagra oculta hidráulica

Empaque con 2 piezas  
Bidimensional  
Cazoleta: 35 mm



CÓDIGO	DESC.	PRECIO PAR	MASTER
BIS0716	Recta	\$ 40.00	100 Pares

## Bisagra oculta hidráulica

Empaque con 2 piezas  
Bidimensional  
Cazoleta: 35 mm



CÓDIGO	DESC.	PRECIO PAR	MASTER
BIS0717	Semi recta	\$ 40.00	100 Pares

## Bisagra oculta hidráulica

Empaque con 2 piezas  
Bidimensional  
Cazoleta: 35 mm



CÓDIGO	DESC.	PRECIO PAR	MASTER
BIS0718	Curva	\$ 40.00	100 Pares

## Bisagra oculta mini

Empaque con 2 piezas  
Bidimensional  
Cazoleta: 26 mm



CÓDIGO	DESC.	PRECIO PAR	MASTER
BIS0719	Recta	\$ 16.00	200 Pares

## Bisagra oculta mini

Empaque con 2 piezas  
Bidimensional  
Cazoleta: 26 mm



CÓDIGO	DESC.	PRECIO PAR	MASTER
BIS0720	Semi recta	\$ 16.00	200 Pares

## Bisagra oculta mini

Empaque con 2 piezas  
Bidimensional  
Cazoleta: 26 mm



CÓDIGO	DESC.	PRECIO PAR	MASTER
BIS0721	Curva	\$ 16.00	200 Pares

## Bisagra oculta 65 grados

Empaque con 2 piezas  
Bidimensional  
Cazoleta: 35 mm



CÓDIGO	DESC.	PRECIO PAR	MASTER
BIS0713	Recta	\$ 16.00	100 Pares

## Bisagra oculta 65 grados

Empaque con 2 piezas  
Bidimensional  
Cazoleta: 35 mm



CÓDIGO	DESC.	PRECIO PAR	MASTER
BIS0714	Semi recta	\$ 16.00	100 Pares

## Bisagra oculta 65 grados

Empaque con 2 piezas  
Bidimensional  
Cazoleta: 35 mm



CÓDIGO	DESC.	PRECIO PAR	MASTER
BIS0715	Curva	\$ 16.00	100 Pares

El aspecto, empaque, inner o master de los productos puede variar sin previo aviso debido a la innovación continua de nuestras marcas.





## Bisagra oculta a 90 grados

Empaque con 2 piezas  
Bidimensional



Incluye: Tornillos  
Bolsa Impresa

CÓDIGO	PRECIO PAR	MASTER
BISO90	\$ 32.00	100 Pares

## Bisagra oculta a 135 grados

Empaque con 2 piezas



Incluye: Tornillos  
Bolsa Impresa

CÓDIGO	PRECIO PAR	MASTER
BISO135	\$ 32.00	100 Pares

## Bisagra oculta a 165 grados



Incluye: Tornillos  
Bolsa Impresa

CÓDIGO	PRECIO PAR	MASTER
BISO165	\$ 36.00	100 Pzas.

## Bisagra oculta para cocina

Bidimensional  
Cazoleta: 35 mm



Recta

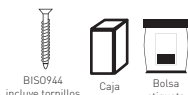

BISO944 incluye tornillos  
Caja  
Bolsa etiqueta

CÓDIGO	DESCRIPCIÓN	PRECIO PAR	MASTER
BISO	Granel	\$ 16.00	100 Pares
BISO944	Bolsa (1 Par)	\$ 18.00	100 Pares

## Bisagra para bastidor laminada



Caja

CÓDIGO	DESCRIPCIÓN	PRECIO PAR	MASTER
BISBL	Granel	\$ 16.00	100 Pares

## Bisagra para bastidor reforzada



BISBR945 incluye tornillos  
Caja  
Bolsa etiqueta

CÓDIGO	DESCRIPCIÓN	PRECIO PAR	MASTER
BISBR	Granel	\$ 26.00	100 Pares
BISBR945	Bolsa (1 Par)	\$ 28.00	100 Pares

## Bisagra de puente

Empaque con 2 piezas



Incluye: Tornillos  
Bolsa Impresa

CÓDIGO	PRECIO PAR	MASTER
BISP946	\$ 27.00	100 Pares

## Bisagra para bastidor cierre lento

Empaque con 2 piezas  
Cazoleta: 35 mm



Incluye: Tornillos  
Bolsa Impresa

CÓDIGO	PRECIO PAR	MASTER
SHBP1949	\$ 60.00	100 Pares

## Bisagra tipo avión

Empaque con 2 piezas  
Cazoleta: 35 mm



Incluye: Tornillos  
Bolsa Impresa

CÓDIGO	PRECIO PAR	MASTER
SHBA1988	\$ 50.00	250 Pares

El aspecto, empaque, inner o master de los productos puede variar sin previo aviso debido a la innovación continua de nuestras marcas.

## Bisagra para puerta (par)

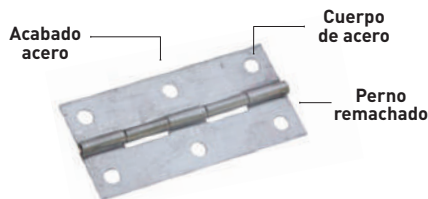

CÓDIGO	DESCRIPCIÓN	PRECIO PAR	INN.	MAS.
BP2517AN	1" x 7/8"	\$ 6.00	12 Pares	1,200 Pares
BP3823AN	1 1/2" x 3/16"	\$ 7.00	12 Pares	1,200 Pares
BP4828AN	2" x 1 1/8"	\$ 10.00	12 Pares	720 Pares
BP6130AN	2 1/2" x 1 1/4"	\$ 11.00	12 Pares	600 Pares
BP7336AN	3" x 1 1/2"	\$ 12.00	12 Pares	600 Pares

## Bisagra para puerta (par)

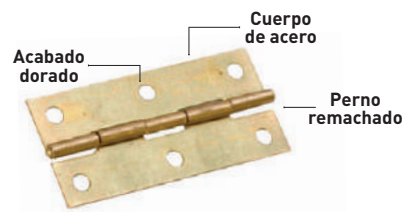

CÓDIGO	DESCRIPCIÓN	PRECIO PAR	INN.	MAS.
BP2517D	1" x 7/8"	\$ 6.00	12 Pares	1,200 Pares
BP3823D	1 1/2" x 3/16"	\$ 7.00	12 Pares	1,200 Pares
BP4828D	2" x 1 1/8"	\$ 10.00	12 Pares	720 Pares
BP6130D	2 1/2" x 1 1/4"	\$ 11.00	12 Pares	600 Pares
BP7336D	3" x 1 1/2"	\$ 12.00	12 Pares	720 Pares

## Bisagra para clóset 3" x 1.5 mm (par)

1.5 mm de grosor  
Cuerpo de acero  
Perno fijo

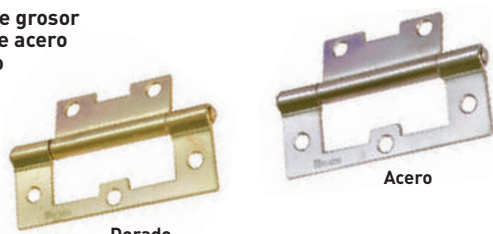

CÓDIGO	DESCRIPCIÓN	PRECIO PAR	INNER	MASTER
BPC3N	Acero	\$ 30.00	10 Pares	200 Pares
BPC3D	Dorada	\$ 30.00	10 Pares	200 Pares

## Bisagra para puerta 3" x 3" (par)

Cuerpo de acero  
Perno fijo



CÓDIGO	DESCRIPCIÓN	PRECIO PAR	INN.	MAS.
BP3D	Dorada (1.6 mm)	\$ 30.00	1 Par	50 Pares
BP3H	Humo (2.0 mm)	\$ 37.00	1 Par	50 Pares
BP3N	Níquel (2.0 mm)	\$ 38.00	1 Par	50 Pares

## Bisagra para puerta 3 1/2" x 3 1/2" (par)

2.2 mm de grosor  
Cuerpo de acero  
Perno fijo

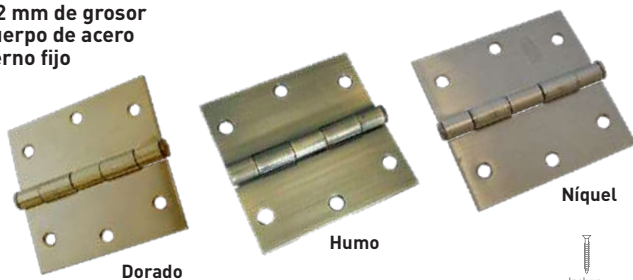

CÓDIGO	DESCRIPCIÓN	PRECIO PAR	INNER	MASTER
BP312D	Dorado	\$ 47.00	1 Par	50 Pares
BP312H	Humo	\$ 47.00	1 Par	50 Pares
BP312N	Níquel	\$ 50.00	1 Par	50 Pares

## Bisagra para puerta 3" x 3" (par)

2 mm de grosor  
Cuerpo de acero  
Perno fijo

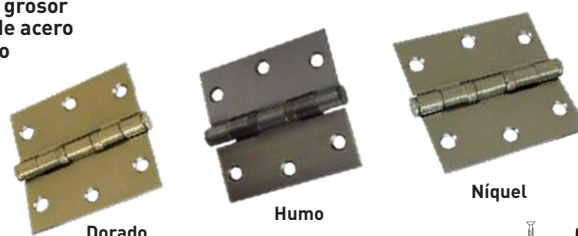

Con baleros para mejor funcionamiento y mayor durabilidad

CÓDIGO	DESCRIPCIÓN	PRECIO PAR	INNER	MASTER
BPA3DP	Dorado pulido	\$ 52.00	1 Par	50 Pares
BPA3HP	Humo pulido	\$ 52.00	1 Par	50 Pares
BPA3NP	Níquel pulido	\$ 52.00	1 Par	50 Pares

## Bisagra para puerta 3 1/2" x 3 1/2" (par)

2 mm de grosor  
Cuerpo de acero  
Perno fijo

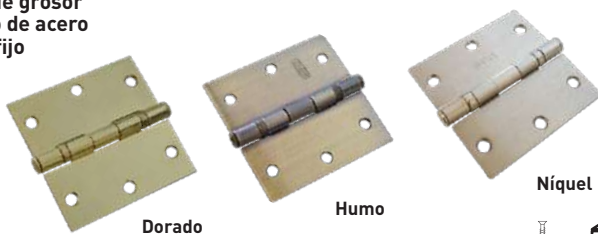

Con baleros para mejor funcionamiento y mayor durabilidad

CÓDIGO	DESCRIPCIÓN	PRECIO PAR	INN.	MAS.
BPA312DP	Dorado pulido	\$ 68.00	1 Par	50 Pares
BPA312HP	Humo pulido	\$ 68.00	1 Par	50 Pares
BPA312NP	Níquel pulido	\$ 68.00	1 Par	50 Pares

## Bisagra para puerta 4" x 4" (par)

2.2 mm de grosor  
Cuerpo de acero  
Perno fijo

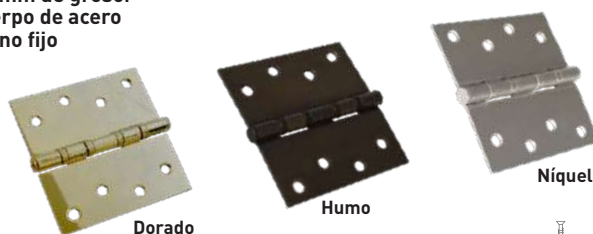

Con baleros para mejor funcionamiento y mayor durabilidad

CÓDIGO	DESCRIPCIÓN	PRECIO PAR	INN.	MAS.
BPA4DP	Dorado pulido	\$ 90.00	1 Par	50 Pares
BPA4HP	Humo pulido	\$ 90.00	1 Par	50 Pares
BPA4NP	Níquel pulido	\$ 90.00	1 Par	50 Pares

El aspecto, empaque, inner o master de los productos puede variar sin previo aviso debido a la innovación continua de nuestras marcas.

## Bisagra para puerta (par)

Cuerpo de acero inoxidable 201

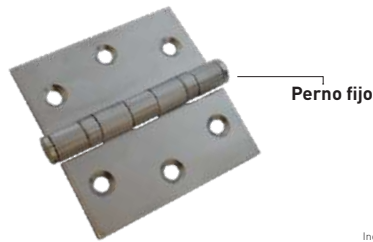

CÓDIGO	DESCRIPCIÓN	PRECIO PAR	INNER	MASTER
BP3SS	3" x 3" x 2.5 mm	\$ 90.00	1 Par	50 Pares
BP312SS	3 1/2" x 3 1/2" x 2.5 mm	\$ 105.00	1 Par	50 Pares
BP4SS	4" x 4" x 3 mm	\$ 180.00	1 Par	40 Pares

## Bisagra para puerta 2 1/2" x 2 1/2" (par)

1.4 mm de grosor  
Cuerpo de acero  
Perno suelto



CÓDIGO	DESCRIPCIÓN	PRECIO PAR	INNER	MASTER
BP212D	Dorada	\$ 22.00	1 Par	200 Pares
BP212N	Acero	\$ 24.00	1 Par	200 Pares

## Bisagra para puerta (par)

Cuerpo de acero

Producto NUEVO

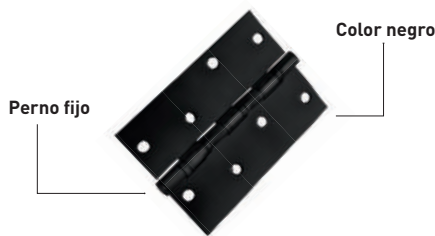

## Bisagra para puerta 2" x 2" (par)

1.3 mm de grosor  
Cuerpo de acero  
Perno suelto

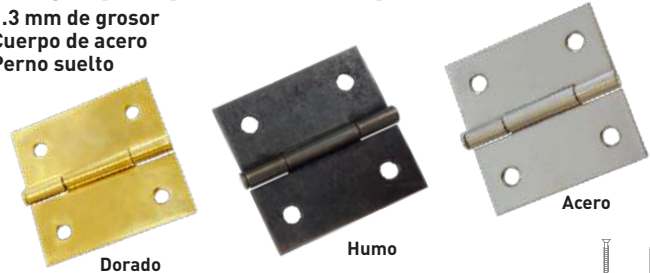

CÓDIGO	DESCRIPCIÓN	PRECIO PAR	MASTER
SHBP2006	3" x 3" x 2.5 mm	\$ 65.00	50 Pares
SHBP2007	3 1/2" x 3 1/2" x 2.5 mm	\$ 80.00	50 Pares
SHBP2008	4" x 4" x 2.5 mm	\$ 100.00	50 Pares

CÓDIGO	DESCRIPCIÓN	PRECIO PAR	INNER	MASTER
BP2D	Dorada	\$ 20.00	1 Par	200 Pares
BP2H	Humo	\$ 23.00	1 Par	200 Pares
BP2N	Acero	\$ 23.00	1 Par	50 Pares

## Bisagra para puerta (par)

Soldable

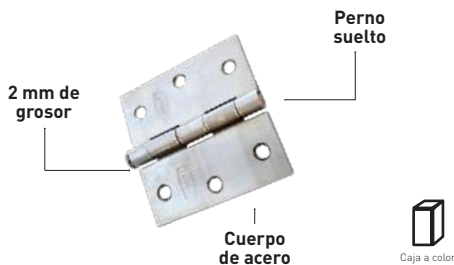

## Bisagra plana para cocina

Empaque con 2 piezas  
Cuerpo metálico

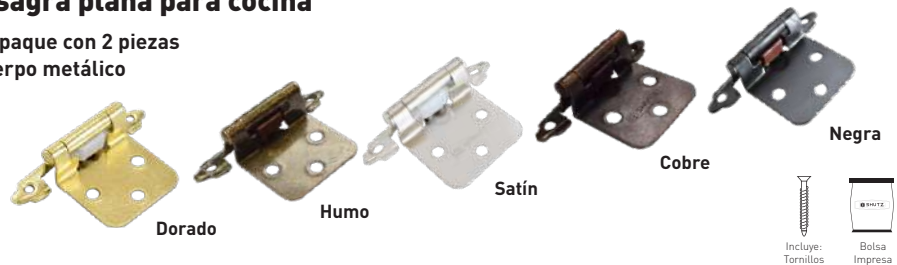

CÓDIGO	DESCRIPCIÓN	PRECIO PAR	INNER	MASTER
BP3S	3" x 3"	\$ 27.00	1 Par	50 Pares
BP312S	3 1/2" x 3 1/2"	\$ 45.00	1 Par	50 Pares

CÓDIGO	DESC.	PRECIO PAR	MASTER
BISPB D	Dorada	\$ 13.00	250 Pares
BISPB H	Humo	\$ 13.00	250 Pares
BISPB S	Satín	\$ 13.00	250 Pares
BISPB C	Cobre	\$ 14.00	250 Pares
BISPB N	Negra	\$ 14.00	250 Pares

## Bisagra para puerta doble acción 3" x 3"

Empaque con 2 piezas  
Cuerpo metálico

Cabeza bola plástica

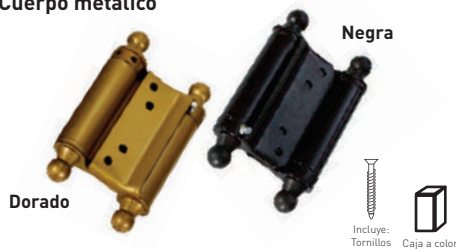

CÓDIGO	DESCRIPCIÓN	PRECIO PAR	MASTER
BDAD3	Dorada	\$ 185.00	25 Pares
BDA3N	Negra	\$ 185.00	25 Pares

## Bisagra plana para cocina

2 piezas a granel  
Cuerpo metálico

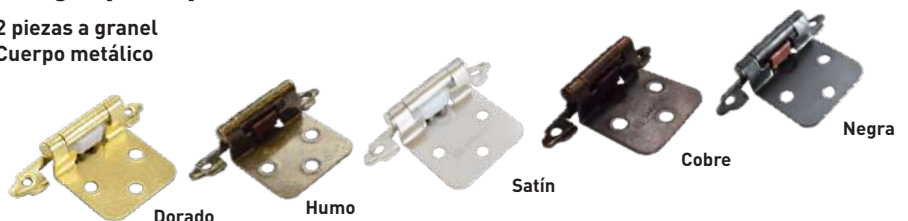

CÓDIGO	DESC.	PRECIO PAR	MASTER
BISPG D	Dorada	\$ 11.50	250 Pares
BISPG H	Humo	\$ 11.50	250 Pares
BISPG S	Satín	\$ 11.50	250 Pares
BISPG C	Cobre	\$ 13.00	250 Pares
BISPG N	Negra	\$ 13.00	250 Pares

El aspecto, empaque, inner o master de los productos puede variar sin previo aviso debido a la innovación continua de nuestras marcas.

## Corredera tipo europeo café

Pintura epóxica



De 12" a 18": Grosor de 0.7 mm  
De 20": Grosor 0.9 mm

CÓDIGO	MEDIDA	PRECIO PAR	MASTER
JRL1275C	12" (30 cm)	\$ 20.00	25 Pares
JRL1276C	14" (35 cm)	\$ 23.00	25 Pares
JRL1277C	16" (40 cm)	\$ 25.00	25 Pares
JRL1278C	18" (45 cm)	\$ 29.00	25 Pares
JRL1279C	20" (50 cm)	\$ 32.00	25 Pares

## Corredera tipo europeo blanca

Pintura epóxica



De 12" a 18": Grosor de 0.7 mm  
De 20": Grosor 0.9 mm

CÓDIGO	MEDIDA	PRECIO PAR	MASTER
JRL12	12" (30 cm)	\$ 20.00	25 Pares
JRL14	14" (35 cm)	\$ 23.00	25 Pares
JRL16	16" (40 cm)	\$ 25.00	25 Pares
JRL18	18" (45 cm)	\$ 29.00	25 Pares
JRL20	20" (50 cm)	\$ 32.00	25 Pares
JRL22	22" (55 cm)	\$ 36.00	25 Pares
JRL24	24" (60 cm)	\$ 40.00	25 Pares

## Corredera de extensión 3/4 (17 mm)



Producto sujeto a disponibilidad\*

CÓDIGO	DESC.	PRECIO PAR	INN.	MAS.
JRE1712	12" (30 cm)	\$ 13.50	1	30
JRE1714	14" (35 cm)	\$ 15.50	1	30
JRE1716	16" (40 cm)	\$ 18.00	1	30
JRE1718	18" (45 cm)	\$ 20.00	1	30
JRE1720	20" (50 cm)	\$ 22.00	1	30

## Corredera de extensión 3/4 (27 mm)

Capacidad de carga (par): 20 kg  
Empaque con 2 piezas



27 mm

CÓDIGO	DESC.	PRECIO PAR	MASTER
JRE2712	12" (30 cm)	\$ 20.00	30 Pares
JRE2714	14" (35 cm)	\$ 23.00	30 Pares
JRE2716	16" (40 cm)	\$ 27.00	30 Pares

## Corredera de extensión total (30 mm)

Capacidad de carga (par): 15 kg  
Empaque con 2 piezas



30 mm

CÓDIGO	DESC.	PRECIO PAR	MASTER
JRE3010	10" (25 cm)	\$ 24.00	30 Pares
JRE3012	12" (30 cm)	\$ 28.00	30 Pares
JRE3014	14" (35 cm)	\$ 32.00	30 Pares
JRE3016	16" (40 cm)	\$ 37.00	30 Pares
JRE3018	18" (45 cm)	\$ 42.00	30 Pares

## Corredera de extensión total (30 mm)

Capacidad de carga (par): 15 kg  
Empaque con 2 piezas  
Color negro



30 mm

CÓDIGO	DESC.	PRECIO PAR	MASTER
JRE1414	12" (30 cm)	\$ 28.00	30 Pares
JRE1415	14" (35 cm)	\$ 32.00	30 Pares
JRE1416	16" (40 cm)	\$ 37.00	30 Pares
JRE1417	18" (45 cm)	\$ 42.00	30 Pares

## Corredera de extensión total (35 mm)

Capacidad de carga (par): 20 kg  
Empaque con 2 piezas

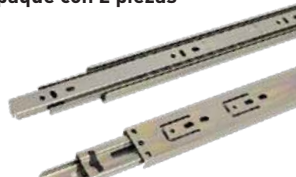

35 mm

CÓDIGO	DESC.	PRECIO PAR	MASTER
JRE3510	10" (25 cm)	\$ 27.00	20 Pares
JRE3512	12" (30 cm)	\$ 33.00	20 Pares
JRE3514	14" (35 cm)	\$ 38.00	20 Pares
JRE3516	16" (40 cm)	\$ 44.00	20 Pares
JRE3518	18" (45 cm)	\$ 47.00	20 Pares
JRE3520	20" (50 cm)	\$ 53.00	20 Pares
JRE3522	22" (55 cm)	\$ 63.00	20 Pares
JRE3524	24" (60 cm)	\$ 66.00	20 Pares

## Corredera de extensión total (35 mm)

Capacidad de carga (par): 20 kg  
Empaque con 2 piezas  
Color negro



35 mm

CÓDIGO	DESCRIPCIÓN	PRECIO PAR	MASTER
JRE1418	12" (30 cm)	\$ 33.00	20 Pares
JRE1419	14" (35 cm)	\$ 38.00	20 Pares
JRE1420	16" (40 cm)	\$ 44.00	20 Pares
JRE1421	18" (45 cm)	\$ 47.00	20 Pares
JRE1422	20" (50 cm)	\$ 53.00	20 Pares

## Corredera de extensión total (45 mm)

Capacidad de carga (par): 35 kg  
Empaque con 2 piezas



45 mm

CÓDIGO	DESCRIPCIÓN	PRECIO PAR	MASTER
JRE4512	12" (30 cm)	\$ 46.00	15 Pares
JRE4514	14" (35 cm)	\$ 53.00	15 Pares
JRE4516	16" (40 cm)	\$ 66.00	15 Pares
JRE4518	18" (45 cm)	\$ 72.00	15 Pares
JRE4520	20" (50 cm)	\$ 80.00	15 Pares
JRE4522	22" (55 cm)	\$ 88.00	15 Pares
JRE4524	24" (60 cm)	\$ 94.00	15 Pares

## Corredera de extensión total (45 mm)

Capacidad de carga (par): 35 kg  
Empaque con 2 piezas  
Color negro



45 mm

CÓDIGO	DESCRIPCIÓN	PRECIO PAR	MASTER
JRE1426	12" (30 cm)	\$ 46.00	15 Pares
JRE1427	14" (35 cm)	\$ 53.00	15 Pares
JRE1424	16" (40 cm)	\$ 66.00	15 Pares
JRE1425	18" (45 cm)	\$ 72.00	15 Pares
JRE1423	20" (50 cm)	\$ 80.00	15 Pares

## Corredera de extensión de cierre lento (45 mm)

Capacidad de carga (par): 35 kg  
Empaque con 2 piezas



45 mm

CÓDIGO	DESCRIPCIÓN	PRECIO PAR	MASTER
JRE722	14" (35 cm)	\$ 126.00	10 Pares
JRE723	16" (40 cm)	\$ 155.00	10 Pares
JRE724	18" (45 cm)	\$ 170.00	10 Pares
JRE725	20" (50 cm)	\$ 185.00	10 Pares
JRE726	22" (55 cm)	\$ 195.00	10 Pares

## Portagarrafón

Extraíble  
Incluye riel



CÓDIGO	DESCRIPCIÓN	PRECIO	INNER	MASTER
SHPG1963	43 x 36 x 35 cm	\$ 1310.00	1	1

## Botelleros 2 niveles

Extraíble  
Incluye riel



CÓDIGO	DESCRIPCIÓN	PRECIO	INNER	MASTER
SHBT1964	12" 45 x 46 x 11 cm	\$ 810.00	1	1
SHBT1965	18" 45 x 46 x 16 cm	\$ 840.00	1	1

## Botellero 3 niveles

Extraíble  
Incluye riel



CÓDIGO	DESCRIPCIÓN	PRECIO	INNER	MASTER
SHBT1966	18" 58 x 46 x 16 cm	\$ 980.00	1	1

## Cesto con riel sencillo

Extraíble  
Incluye riel



CÓDIGO	DESCRIPCIÓN	PRECIO	INNER	MASTER
SHCT1967	Riel sencillo 46 x 34 x 36 cm	\$ 765.00	1	1

## Cesto con riel doble

Extraíble  
Incluye riel



CÓDIGO	DESCRIPCIÓN	PRECIO	INNER	MASTER
SHCT1968	Riel doble 46 x 34 x 50 cm	\$ 1140.00	1	1

## Piston elevable 8 kg 80 N para puerta de madera o aluminio

Para panel de madera y aluminio

80 N de presión

Resistencia: 8 kg



CÓDIGO	PRECIO	INNER	MASTER
PE569	\$ 44.00	10	100

## Pistón elevable

Para panel de madera



CÓDIGO	DESCRIPCIÓN	PRECIO	INN.	MAS.
PE426	100 N 10 kg	\$ 42.00	10	100
PE427	80 N 8 kg	\$ 41.00	10	100
SHBR1987	60 N 6 kg	\$ 40.00	10	100

## Amortiguador para mueble

Empaque con 2 piezas

Producto NUEVO



Precio unitario \$ 21.00

CÓDIGO	DESCRIPCIÓN	PRECIO PAR	INNER	MASTER
SHAM1950	Blanco	\$ 42.00	1 Par	50 Pares
SHAM1951	Blanco - Gris	\$ 42.00	1 Par	50 Pares
SHAM1952	Gris	\$ 42.00	1 Par	50 Pares
SHAM1953	Negro	\$ 42.00	1 Par	50 Pares

## Soporte compás

Producto NUEVO



Cuerpo metálico



CÓDIGO	DESCRIPCIÓN	PRECIO	INN.	MAS.
SHBR1959	Con freno	\$ 160.00	10	100
SHBR1960	Sin freno	\$ 150.00	10	100

## Pija para bisagra

Caja



CÓDIGO	DESCRIPCIÓN	PRECIO	MASTER
TB12CH	6 x 1/2" Humo (latón)	\$ 3,000.00	25,000
TB12CD	6 x 1/2" Dorado (latón)	\$ 3,000.00	25,000
TB12CA	6 x 1/2" Aluminio	\$ 2,500.00	25,000
TB58CD	6 x 5/8" Dorado (latón)	\$ 2,900.00	20,000
TB58CH	6 x 5/8" Humo (latón)	\$ 2,900.00	20,000
TB58CA	6 x 5/8" Aluminio	\$ 2,500.00	20,000

## Pija para bisagra

Bolsa



CÓDIGO	DESCRIPCIÓN	PRECIO	MASTER
TB12MH	6 x 1/2" Humo (latón)	\$ 135.00	1,000
TB12MD	6 x 1/2" Dorado (latón)	\$ 135.00	1,000
TB12MA	6 x 1/2" Aluminio	\$ 110.00	1,000
TB58MD	6 x 5/8" Dorado (latón)	\$ 165.00	1,000
TB58MH	6 x 5/8" Humo (latón)	\$ 165.00	1,000
TB58MA	6 x 5/8" Aluminio	\$ 155.00	1,000

## Tornillo mosquitero

Caja



CÓDIGO	DESCRIPCIÓN	PRECIO	MASTER
TM712C	7 x 1/2"	\$ 3,500.00	20,000

## Pija cabeza hexagonal con rondana de neopreno

Caja



CÓDIGO	DESCRIPCIÓN	PRECIO	MASTER
TLM114C	8 x 1 1/4"	\$ 1,950.00	4,000
TLM112C	8 x 1 1/2"	\$ 2,400.00	3,500
TLM2C	8 x 2"	\$ 2,400.00	3,000
TLM212C	8 x 2 1/2"	\$ 2,200.00	2,500
TLM83C	8 x 3"	\$ 2,200.00	2,000
TLM141C	14 x 1"	\$ 3,200.00	3,500
TLM14114C	14 x 1 1/4"	\$ 3,000.00	3,000
TLM14112C	14 x 1 1/2"	\$ 2,900.00	2,500
TLM142C	14 x 2"	\$ 2,700.00	2,000
TLM14212C	14 x 2 1/2"	\$ 2,400.00	1,500
TLM143C	14 x 3"	\$ 2,100.00	1,000

## Pija cabeza hexagonal con rondana de neopreno

Bolsa



CÓDIGO	DESCRIPCIÓN	PRECIO	MASTER
TLM114B	8 x 1 1/4"	\$ 60.00	100
TLM112B	8 x 1 1/2"	\$ 80.00	100
TLM2B	8 x 2"	\$ 95.00	100
TLM212B	8 x 2 1/2"	\$ 100.00	100
TLM83B	8 x 3"	\$ 120.00	100
TLM141B	14 X 1"	\$ 120.00	100
TLM14114B	14 x 1 1/4"	\$ 135.00	100
TLM14112B	14 x 1 1/2"	\$ 140.00	100
TLM142B	14 x 2"	\$ 165.00	100
TLM14212B	14 x 2 1/2"	\$ 190.00	100
TLM143B	14 x 3"	\$ 230.00	100

## Tornillo mosquitero

Bolsa



CÓDIGO	DESCRIPCIÓN	PRECIO	MASTER
TM712B	7 x 1/2"	\$ 195.00	1,000

## Pija cabeza hexagonal punta de broca con rondana de neopreno

Caja



CÓDIGO	DESCRIPCIÓN	PRECIO	MASTER
TPB1234C	12 x 3/4"	\$ 3,150.00	4,500
TPB121C	12 x 1"	\$ 2,700.00	4,000
TPB12114C	12 x 1 1/4"	\$ 2,800.00	3,500
TPB12112C	12 x 1 1/2"	\$ 2,800.00	3,000
TPB34C	14 x 3/4"	\$ 3,200.00	4,000
TPB1C	14 x 1"	\$ 2,950.00	3,500
TPB14114C	14 x 1 1/4"	\$ 3,050.00	3,000
TPB112C	14 x 1 1/2"	\$ 2,000.00	2,500
TPB2C	14 x 2"	\$ 2,800.00	2,000
TPB212C	14 x 2 1/2"	\$ 2,700.00	1,500
TPB3C	14 x 3"	\$ 2,000.00	1,000

## Pija cabeza hexagonal punta de broca con rondana de neopreno

Bolsa



CÓDIGO	DESCRIPCIÓN	PRECIO	MASTER
TPB1234B	12 x 3/4"	\$ 75.00	100
TPB121B	12 x 1"	\$ 75.00	100
TPB12114B	12 x 1 1/4"	\$ 95.00	100
TPB12112B	12 x 1 1/2"	\$ 115.00	100
TPB34B	14 x 3/4"	\$ 90.00	100
TPB1B	14 x 1"	\$ 95.00	100
TPB14114B	14 x 1 1/4"	\$ 125.00	100
TPB112B	14 x 1 1/2"	\$ 135.00	100
TPB2B	14 x 2"	\$ 145.00	100
TPB212B	14 x 2 1/2"	\$ 185.00	100
TPB3B	14 x 3"	\$ 220.00	100

## Rondana de neopreno

Arandela metálica



Precio por bolsa con 500 piezas

CÓDIGO	PRECIO	BOLSA
GUATPB	\$ 130.00	500



## Pija para lámina cabeza combinada punta de broca #8

Caja



Caja Impresa

CÓDIGO	DESCRIPCIÓN	PRECIO	MASTER
TVPB12C	8 x 1/2"	\$ 2,850.00	12,000
TVPB34C	8 x 3/4"	\$ 3,050.00	10,000
TVPB1C	8 x 1"	\$ 3,150.00	8,000
TVPB114C	8 x 1 1/4"	\$ 3,500.00	7,000

## Pija para lámina cabeza combinada punta de broca #8

Bolsa



Bolsa etiqueta

CÓDIGO	DESCRIPCIÓN	PRECIO	MASTER
TVPB12B	8 x 1/2"	\$ 132.00	500
TVPB34B	8 x 3/4"	\$ 170.00	500
TVPB1B	8 x 1"	\$ 220.00	500
TVPB114B	8 x 1 1/4"	\$ 280.00	500

## Pija plana combinada



Caja Impresa

CÓDIGO	DESCRIPCIÓN	PRECIO	MASTER
TT34	6 x 3/4"	\$ 1,270.00	10,000
TT1	6 x 1"	\$ 1,480.00	10,000
TT114	6 x 1 1/4"	\$ 1,400.00	8,000
TT112	6 x 1 1/2"	\$ 1,220.00	6,000
TT158	6 x 1 5/8"	\$ 1,110.00	5,000
TT2	6 x 2"	\$ 950.00	3,500
TT212	7 x 2 1/2"	\$ 930.00	2,500
TT3	8 x 3"	\$ 1,040.00	2,000
TT312	10 x 3 1/2"	\$ 840.00	1,000
TT4	10 x 4"	\$ 930.00	1,000
TT834	8 x 3/4"	\$ 1,700.00	10,000
TT81	8 x 1"	\$ 1,550.00	8,000
TT8114	8 x 1 1/4"	\$ 1,450.00	6,000
TT8112	8 x 1 1/2"	\$ 1,430.00	5,000
TT8158	8 x 1 5/8"	\$ 950.00	3,500
TT82	8 x 2"	\$ 1,060.00	3,000

## Pija cabeza de cruz punta de broca

Caja



Caja Impresa

CÓDIGO	DESCRIPCIÓN	PRECIO	MASTER
TA12C	8 x 1/2"	\$ 3,200.00	15,000
TA34C	8 x 3/4"	\$ 2,600.00	10,000
TA1C	8 x 1"	\$ 2,400.00	8,000
TA114C	8 x 1 1/4"	\$ 2,100.00	6,000
TA112C	8 x 1 1/2"	\$ 2,050.00	5,000
TA158C	8 x 1 5/8"	\$ 2,700.00	5,000

## Pija cabeza de cruz punta de broca

Bolsa



Bolsa etiqueta

CÓDIGO	DESCRIPCIÓN	PRECIO	MASTER
TA12B	8 x 1/2"	\$ 120.00	500
TA34B	8 x 3/4"	\$ 150.00	500
TA1B	8 x 1"	\$ 100.00	300
TA114B	8 x 1 1/4"	\$ 85.00	200
TA112B	8 x 1 1/2"	\$ 100.00	200
TA158B	8 x 1 5/8"	\$ 120.00	200

## Pija plana punta de broca



Rosca fina



Caja Impresa

CÓDIGO	DESCRIPCIÓN	PRECIO	MASTER
TTFPB1	6 x 1"	\$ 1,950.00	10,000
TTFPB114	6 x 1 1/4"	\$ 1,750.00	8,000
TTFPB112	6 x 1 1/2"	\$ 1,400.00	6,000
TTFPB2	6 x 2"	\$ 1,250.00	3,500

## Pija plana punta de broca

Caja 2 kg



Rosca fina



Caja Impresa

CÓDIGO	DESCRIPCIÓN	PRECIO	MASTER
TTFPB1K2	6 x 1"	\$ 280.00	2 kg
TTFPB114K2	6 x 1 1/4"	\$ 280.00	2 kg
TTFPB112K2	6 x 1 1/2"	\$ 280.00	2 kg
TTFPB2K2	6 x 2"	\$ 280.00	2 kg

## Pija plana combinada

Caja 2 kg



Caja Impresa

CÓDIGO	DESCRIPCIÓN	PRECIO	MASTER
TT34K2	6 x 3/4"	\$ 260.00	2 kg
TT1K2	6 x 1"	\$ 260.00	2 kg
TT114K2	6 x 1 1/4"	\$ 260.00	2 kg
TT112K2	6 x 1 1/2"	\$ 260.00	2 kg
TT158K2	6 x 1 5/8"	\$ 260.00	2 kg
TT2K2	6 x 2"	\$ 260.00	2 kg
TT212K2	7 x 2 1/2"	\$ 260.00	2 kg
TT3K2	8 x 3"	\$ 260.00	2 kg
TT312K2	10 x 3 1/2"	\$ 260.00	2 kg
TT4K2	10 x 4"	\$ 260.00	2 kg
TT834K2	8 x 3/4"	\$ 260.00	2 kg
TT81K2	8 x 1"	\$ 260.00	2 kg
TT8114K2	8 x 1 1/4"	\$ 260.00	2 kg
TT8112K2	8 x 1 1/2"	\$ 260.00	2 kg
TT8158K2	8 x 1 5/8"	\$ 260.00	2 kg
TT82K2	8 x 2"	\$ 260.00	2 kg

## Pija plana



Rosca fina



Caja Impresa

CÓDIGO	DESCRIPCIÓN	PRECIO	MASTER
TTF1	6 x 1"	\$ 1,500.00	10,000
TTF114	6 x 1 1/4"	\$ 1,400.00	8,000
TTF112	6 x 1 1/2"	\$ 1,200.00	6,000
TTF2	6 x 2"	\$ 900.00	3,500

## Pija plana

Caja 2 kg



Rosca fina



Caja Impresa

CÓDIGO	DESCRIPCIÓN	PRECIO	MASTER
TTF1K2	6 x 1"	\$ 260.00	2 kg
TTF114K2	6 x 1 1/4"	\$ 260.00	2 kg
TTF112K2	6 x 1 1/2"	\$ 260.00	2 kg
TTF2K2	6 x 2"	\$ 260.00	2 kg

## Pija para bastidor combinada punta phillips-cuadrada

Caja



CÓDIGO	DESCRIPCIÓN	PRECIO	MASTER
TB112C	1 1/2"	\$ 2,600.00	6,000
TB114C	1 1/4"	\$ 2,200.00	7,500

## Pija para bastidor combinada punta phillips-cuadrada

Bolsa



CÓDIGO	DESCRIPCIÓN	PRECIO	MASTER
TB112B	1 1/2"	\$ 145.00	300
TB114B	1 1/4"	\$ 100.00	300

## Pija para bastidor punta phillips

Caja



CÓDIGO	DESCRIPCIÓN	PRECIO	MASTER
TB112PC	1 1/2"	\$ 2,600.00	7,500
TB114PC	1 1/4"	\$ 2,200.00	7,500

## Pija para bastidor punta phillips

Bolsa



CÓDIGO	DESCRIPCIÓN	PRECIO	MASTER
TB112PB	1 1/2"	\$ 145.00	300
TB114PB	1 1/4"	\$ 100.00	300

## Pija klath punta afilada

Caja



CÓDIGO	DESCRIPCIÓN	PRECIO	MASTER
TK812C	8 x 1/2"	\$ 2,600.00	15,000
TK834C	8 x 3/4"	\$ 2,100.00	10,000
TK81C	8 x 1"	\$ 2,200.00	8,000

## Pija klath punta afilada

Bolsa



CÓDIGO	DESCRIPCIÓN	PRECIO	MASTER
TK812B	8 x 1/2"	\$ 100.00	500
TK834B	8 x 3/4"	\$ 120.00	500
TK81B	8 x 1"	\$ 85.00	300

## Tornillo para jaladera 8/32"

Caja



CÓDIGO	DESCRIPCIÓN	PRECIO	MASTER
TJ34C	3/4"	\$ 2,500.00	9,000
TJ78C	7/8"	\$ 2,300.00	8,000
TJ1C	1"	\$ 2,200.00	7,000
TJ118C	1 1/8"	\$ 2,100.00	6,500
TJ114C	1 1/4"	\$ 2,200.00	6,000
TJ112C	1 1/2"	\$ 1,900.00	4,500
TJ158C	1 5/8"	\$ 1,650.00	4,000
TJ134C	1 3/4"	\$ 1,800.00	3,500

## Tornillo para jaladera 8/32"

Bolsa



CÓDIGO	DESCRIPCIÓN	PRECIO	BOLSA
TJ34B	3/4"	\$ 150.00	500
TJ78B	7/8"	\$ 160.00	500
TJ1B	1"	\$ 180.00	500
TJ118B	1 1/8"	\$ 175.00	500
TJ114B	1 1/4"	\$ 200.00	500
TJ112B	1 1/2"	\$ 235.00	500
TJ158B	1 5/8"	\$ 215.00	500
TJ134B	1 3/4"	\$ 280.00	500

## Pija para lamina cabeza combinada #8



CÓDIGO	DESCRIPCIÓN	PRECIO	MASTER
TV12C	8 x 1/2"	\$ 2,300.00	12,000
TV34C	8 x 3/4"	\$ 2,500.00	10,000
TV1C	8 x 1"	\$ 2,600.00	8,000
TV114C	8 x 1 1/4"	\$ 2,600.00	7,000
TV112C	8 x 1 1/2"	\$ 2,700.00	6,000
TV2C	8 x 2"	\$ 2,600.00	5,000

## Pija para lamina cabeza combinada #8



CÓDIGO	DESCRIPCIÓN	PRECIO	BOLSA
TV12B	8 x 1/2"	\$ 120.00	500
TV34B	8 x 3/4"	\$ 150.00	500
TV1B	8 x 1"	\$ 165.00	500
TV114B	8 x 1 1/4"	\$ 115.00	300
TV112B	8 x 1 1/2"	\$ 90.00	200
TV2B	8 x 2"	\$ 115.00	200

## Pija para lamina cabeza combinada #10, #12 Y #14



CÓDIGO	DESCRIPCIÓN	PRECIO	MASTER
TBR101	10 x 1"	\$ 50.00	100
TBR10112	10 x 1 1/2"	\$ 65.00	100
TBR102	10 x 2"	\$ 80.00	100
TBR10212	10 x 2 1/2"	\$ 95.00	100
TBR103	10 x 3"	\$ 115.00	100
TBR121	12 x 1"	\$ 65.00	100
TBR12112	12 x 1 1/2"	\$ 85.00	100
TBR122	12 x 2"	\$ 115.00	100
TBR12212	12 x 2 1/2"	\$ 135.00	100
TBR123	12 x 3"	\$ 165.00	100
TBR141	14 x 1"	\$ 95.00	100
TBR14112	14 x 1 1/2"	\$ 122.00	100
TBR142	14 x 2"	\$ 145.00	100
TBR14212	14 x 2 1/2"	\$ 190.00	100
TBR143	14 x 3"	\$ 225.00	100



## Taquete para tablaroca 14 x 42 mm

Producto **NUEVO**



Producto sujeto a disponibilidad\*

CÓDIGO	INNER	MASTER
SHTT2067	1	50 Piezas
SHTT2071	1	200 Piezas

## Taquete ancla



CÓDIGO	DESCRIPCIÓN	PRECIO	MASTER
TQA14	1/4" x 2 1/2"	\$ 5.00	800
TQA38	3/8" x 3"	\$ 9.00	400
TQA12	1/2" x 3 1/2"	\$ 14.50	200

## Tornillo sujetador mariposa



CÓDIGO	DESC.	PRECIO	MAS.
TSM14	3" x 1/4"	\$ 7.00	350
TSM316	3" x 3/16"	\$ 5.00	550

## Inserto

Piezas a granel

Producto **NUEVO**



CÓDIGO	DESCRIPCIÓN	PRECIO	BOLSA	MAS.
SHIN1954	Sin tope 1/4"	\$ 1,500.00	1	500
SHIN1955	Sin tope 3/8"	\$ 1,800.00	1	500
SHIN1954B	Sin tope 1/4"	\$ 360.00	1	100
SHIN1955B	Sin tope 3/8"	\$ 420.00	1	100

## Juego de sujeción (21 piezas)

**Juego de sujeción café incluye:**  
10 Taquetes café 5/16"

10 pijas para lámina cabeza combinada #12 x 1"

1 punta para taladro

**Juego de sujeción rojo incluye:**  
10 Taquetes rojos 1/4"

10 pijas lámina cabeza combinada #10 x 1"

1 Punta para taladro



CÓDIGO	DESCRIPCIÓN	PRECIO	INNER	MASTER
JGOS516	Café - 5/16"	\$26.50	1	12
JGOS14	Rojo - 1/4"	\$26.50	1	12

## Taquete de sujeción de plástico (100 piezas)



CÓDIGO	DESCRIPCIÓN	PRECIO	INNER	MASTER
TS553	Gris 3/16"	\$ 16.00	25	100
TS554	Rojo 1/4"	\$ 18.00	25	100
TS555	Café 5/16"	\$ 29.00	25	100
TS556	Azul 3/8"	\$ 50.00	25	100

## Dado magnético cabeza hexagonal

Paquete con 5 piezas

Cilindro de acero al cromo vanadio



CÓDIGO	DESC.	PRECIO PAQUETE	INN.	MAS.
DADM38	3/8"	\$ 95.00	10	500
DADM14	1/4"	\$ 105.00	10	500
DADM516	5/16"	\$ 105.00	10	500

## Embellecedor para tornillo

1 Set ( 4 Piezas )

Producto **NUEVO**



CÓDIGO	DESC.	PRECIO SET	INN.	MAS.
SHEM1956	16 mm	\$ 30.00	1	250
SHEM1957	19 mm	\$ 32.00	1	250
SHEM1958	25 mm	\$ 40.00	1	250

## Aldaba redonda



CÓDIGO	DESCRIPCIÓN	PRECIO	PIEZAS POR CAJA
R1840	18 x 40 mm	\$ 130.00	50
R1950	19 x 50 mm	\$ 130.00	50
R2060	20 x 60 mm	\$ 200.00	50
R2280	22 x 80 mm	\$ 320.00	50
R22100	22 x 100 mm	\$ 400.00	50
R23120	23 x 120 mm	\$ 320.00	25
R23150	23 x 150 mm	\$ 340.00	25

## Armella abierta

Medida nominal



CÓDIGO	DESCRIPCIÓN	PRECIO	PIEZAS POR CAJA
AA1530	15 x 30 mm	\$ 40.00	144
AA1740	17 x 40 mm	\$ 80.00	144
AA1850	18 x 50 mm	\$ 90.00	144
AA1960	19 x 60 mm	\$ 135.00	144
AA2070	20 x 70 mm	\$ 150.00	144
AA2180	21 x 80 mm	\$ 180.00	144
AA2290	22 x 90 mm	\$ 270.00	144
AA22100	22 x 100 mm	\$ 195.00	72
AA23110	23 x 110 mm	\$ 240.00	72
AA24120	24 x 120 mm	\$ 270.00	72
AA25130	25 x 130 mm	\$ 380.00	72
AA25150	25 x 150 mm	\$ 420.00	72

## Armella cerrada



CÓDIGO	DESCRIPCIÓN	PRECIO	PIEZAS POR CAJA
AC1530	15 x 30 mm	\$ 40.00	144
AC1740	17 x 40 mm	\$ 80.00	144
AC1745	17 x 45 mm	\$ 85.00	144
AC1850	18 x 50 mm	\$ 90.00	144
AC1960	19 x 60 mm	\$ 135.00	144
AC2070	20 x 70 mm	\$ 150.00	144
AC2290	22 x 90 mm	\$ 270.00	144
AC22100	22 x 100 mm	\$ 195.00	72
AC23110	23 x 110 mm	\$ 240.00	72
AC24120	24 x 120 mm	\$ 270.00	72
AC25130	25 x 130 mm	\$ 380.00	72
AC25150	25 x 150 mm	\$ 420.00	72

## Pasacables redondo

Producto **NUEVO**



SHPC1944

SHPC1945

SHPC1946



## Pasacables cuadrado

Producto **NUEVO**

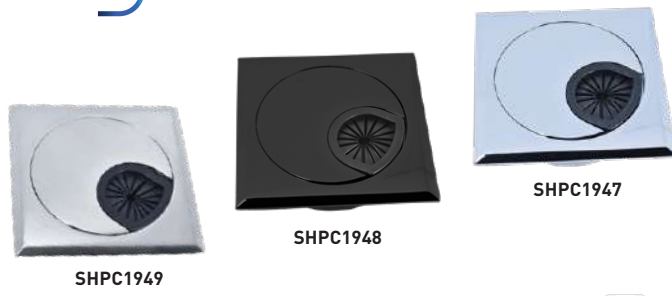

SHPC1949

SHPC1948

SHPC1947



CÓDIGO	DESCRIPCIÓN	precio	INN.	MAS.
SHPC1944	Níquel, 60 mm	\$ 49.00	10	100
SHPC1945	Negro, 60 mm	\$ 49.00	10	100
SHPC1946	Cromo, 60 mm	\$ 49.00	10	100

CÓDIGO	DESCRIPCIÓN	precio	INN.	MAS.
SHPC1949	Satinado, 60 mm	\$ 85.00	10	100
SHPC1947	Negro, 60 mm	\$ 85.00	10	100
SHPC1948	Cromado, 60 mm	\$ 85.00	10	100

## Rodaja nylon con espiga

## Rodaja nylon con perno

## Rodaja nylon con placa



CÓDIGO	DESCRIPCIÓN	PRECIO	INNER	MASTER
RNE40	40 mm - 20 Kg	\$ 12.00	4	240
RNE50	50 mm - 30 Kg	\$ 15.00	4	240

CÓDIGO	DESCRIPCIÓN	PRECIO	INNER	MASTER
RNPE40	40 mm - 20 Kg	\$ 12.00	4	240
RNPE50	50 mm - 30 Kg	\$ 16.00	4	240

CÓDIGO	DESCRIPCIÓN	PRECIO	INNER	MASTER
RNP40	40 mm - 20 Kg	\$ 11.00	10	240
RNP50	50 mm - 30 Kg	\$ 14.00	10	240

## Rodaja esférica con espiga

## Rodaja esférica con placa



Cuerpo metálico



Cuerpo metálico



CÓDIGO	DESCRIPCIÓN	PRECIO	INNER	MASTER
RBPE40	40 mm - 20 Kg	\$ 22.00	30	120
RBPE50	50 mm - 30 Kg	\$ 26.00	30	120

CÓDIGO	DESCRIPCIÓN	PRECIO	INNER	MASTER
RBP40	40 mm - 20 Kg	\$ 22.00	50	100
RBP50	50 mm - 30 Kg	\$ 24.00	50	100

## Cerradura para puerta principal "Munich"

Alta seguridad  
Cilindro de latón sólido  
Incluye cerrojo electrónico  
Ajustable para puertas de 1 3/8" a 2"



**CERROJO ELECTRÓNICO**  
-Indicador de batería  
-Modo vacaciones  
-Bloqueo de protección  
-Hasta 50 códigos de usuario

CÓDIGO	DESCRIPCIÓN	INNER	MASTER
SHPE2074	Níquel satinado	1	6
SHPE2075	Negro mate	1	6

## Cerradura para puerta principal "Bilbao"

Alta seguridad  
Cilindro de latón sólido  
Llave/mariposa  
Ajustable para puertas de 1 3/8" a 2"

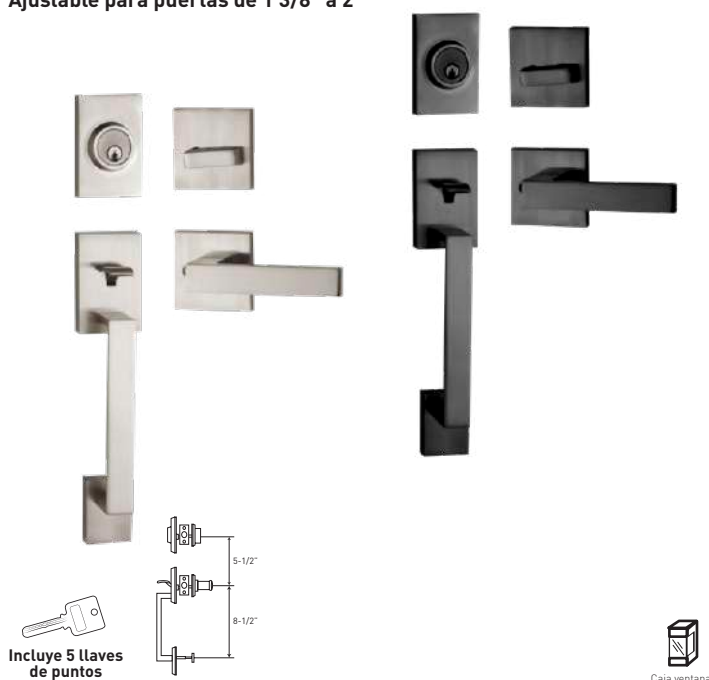

CÓDIGO	DESCRIPCIÓN	INNER	MASTER
SHPP2072	Níquel satinado	1	6
SHPP2073	Negro mate	1	6

## Cerradura para puerta principal "Verona"

Alta seguridad  
Cilindro de latón sólido  
Llave/mariposa  
Ajustable para puertas de 1 3/8" a 2"



CÓDIGO	DESCRIPCIÓN	INNER	MASTER
SHPP2076	Níquel satinado	1	6
SHPP2077	Negro mate	1	6

## Cerradura para puerta principal "Marsella"

Alta seguridad  
Cilindro de latón sólido  
Llave/mariposa  
Ajustable para puertas de 1 3/8" a 2"



CÓDIGO	DESCRIPCIÓN	INNER	MASTER
SHPP2054	Níquel satinado	1	6
SHPP2055	Negro mate	1	6

El aspecto, empaque, inner o master de los productos puede variar sin previo aviso debido a la innovación continua de nuestras marcas.

**TRUEPOWER®**

**HERRAMIENTA**



# PRODUCTO NUEVO

## Parrilla blanca 1 quemador

Encendido manual  
Fuente de energía: Gas LP



## Parrilla blanca 2 quemadores

Encendido manual  
Fuente de energía: Gas LP

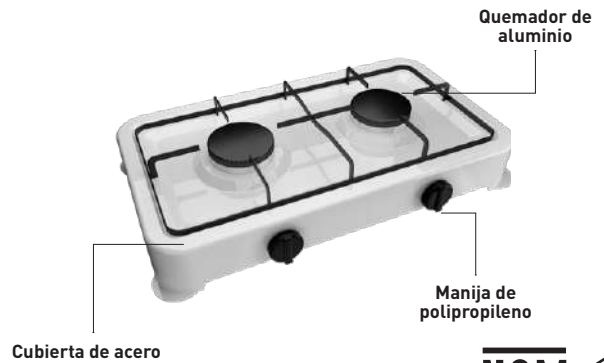

CÓDIGO	DESCRIPCIÓN	PRECIO	INNER	MASTER
TP1262	265 x 60 x 265 mm	\$ 200.00	1	1

CÓDIGO	DESCRIPCIÓN	PRECIO	INNER	MASTER
TP1263	460 x 60 x 265 mm	\$ 350.00	1	1

## Parrilla blanca 4 quemadores

Encendido manual  
Fuente de energía: Gas LP

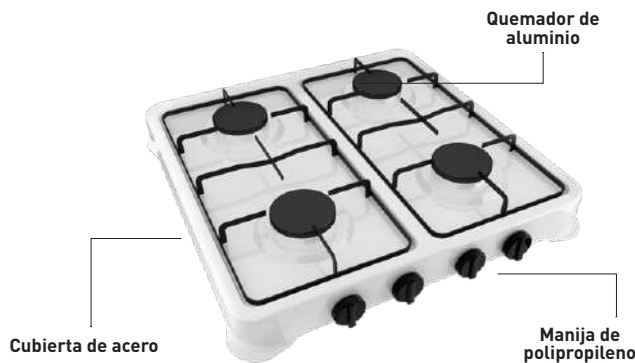

CÓDIGO	DESCRIPCIÓN	PRECIO	INNER	MASTER
TP1264	480 x 60 x 470 mm	\$ 700.00	1	1

## Disco lija para madera lijadora orbital 5" 5 piezas

8 Perforaciones  
Abrasivo de óxido de aluminio  
Respaldo de velcro



CÓDIGO	GRANO	PIEZA	PAQUETE	INNER	MASTER
TP1250	40	\$ 6.80	\$ 34.00	10	100
TP1251	60	\$ 6.80	\$ 34.00	10	100
TP1252	80	\$ 6.80	\$ 34.00	10	100
TP1253	120	\$ 6.80	\$ 34.00	10	100
TP1254	180	\$ 6.80	\$ 34.00	10	100
TP1255	240	\$ 6.80	\$ 34.00	10	100
TP1256	320	\$ 6.80	\$ 34.00	10	100

## Disco lija mallanet 5" 5 piezas

Abrasivo de óxido de aluminio  
Mantiene su forma original  
Lijado en seco  
Limpia fácil

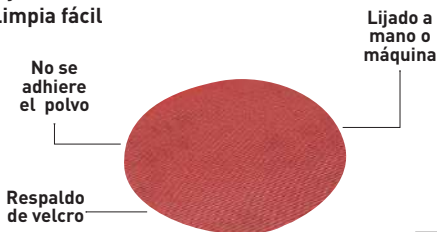

Dura 5 veces más que los abrasivos convencionales

CÓDIGO	GRANO	PIEZA	PAQUETE	INNER	MASTER
TP1240	80	\$ 12.00	\$ 60.00	10	100
TP1241	120	\$ 12.00	\$ 60.00	10	100
TP1242	150	\$ 12.00	\$ 60.00	10	100
TP1243	180	\$ 12.00	\$ 60.00	10	100
TP1244	220	\$ 12.00	\$ 60.00	10	100

## Lija banda para madera 3" x 21" 5 piezas

Abrasivo de óxido de aluminio  
Respaldo de tela



CÓDIGO	GRANO	PIEZA	PAQUETE	INNER	MASTER
TP1220	36	\$ 26.00	\$ 130.00	5	80
TP1221	40	\$ 26.00	\$ 130.00	5	80
TP1222	50	\$ 26.00	\$ 130.00	5	80
TP1223	60	\$ 26.00	\$ 130.00	5	100
TP1224	80	\$ 26.00	\$ 130.00	5	100
TP1225	100	\$ 26.00	\$ 130.00	5	100
TP1226	120	\$ 26.00	\$ 130.00	5	100

## Lija banda para madera 4" x 24" 5 piezas

Abrasivo de óxido de aluminio  
Respaldo de tela



CÓDIGO	GRANO	PIEZA	PAQUETE	INNER	MASTER
TP1227	36	\$ 35.00	\$ 175.00	5	50
TP1228	40	\$ 35.00	\$ 175.00	5	50
TP1229	50	\$ 35.00	\$ 175.00	5	50
TP1230	60	\$ 35.00	\$ 175.00	5	60
TP1231	80	\$ 35.00	\$ 175.00	5	60
TP1232	100	\$ 35.00	\$ 175.00	5	60
TP1233	120	\$ 35.00	\$ 175.00	5	60

PRODUCTO NUEVO

El aspecto, empaque, inner o master de los productos puede variar sin previo aviso debido a la innovación continua de nuestras marcas.

**Compresor de aire horizontal**

Incluye aceite lubricante

**2HP**

**3,400 RPM**



**115 PSI**



Caja a color

**Compresor de aire horizontal**

Incluye aceite lubricante

**2.5HP**

**3,400 RPM**



**115 PSI**



Caja a color

**CARACTERÍSTICAS**

**CARACTERÍSTICAS**

Potencia máxima	2 HP
Potencia nominal	1 HP
Presión máxima	115 psi
Velocidad	3,400 RPM
Tensión	120 V ~
Frecuencia	60 Hz
Flujo de aire	2.9 CFM @ 90 psi - 2.3 CFM @ 115 psi
Amperaje	8 A
Capacidad	24 L
Peso	18 kg

Potencia máxima	2.5 HP
Potencia nominal	1.5 HP
Presión máxima	115 psi
Velocidad	3,400 RPM
Tensión	120 V ~
Frecuencia	60 Hz
Flujo de aire	4.35 CFM @ 90 psi - 3.56 CFM @ 115 psi
Amperaje	13 A
Capacidad	50 L
Peso	26 kg

CÓDIGO	PRECIO	INNER
TPAC224	\$ 3,330.00	1

CÓDIGO	PRECIO	INNER
TPAC2510	\$ 4,280.00	1

**Compresor de aire vertical**

Incluye aceite lubricante

**2.5HP**

**3,400 RPM**



**115 PSI**



Caja a color

**Compresor de aire horizontal**

Incluye aceite lubricante

**3HP**

**3,400 RPM**



**115 PSI**



Caja a color

**CARACTERÍSTICAS**

**CARACTERÍSTICAS**

Potencia máxima	2.5 HP
Potencia nominal	1.5 HP
Presión máxima	115 psi
Velocidad	3,400 RPM
Tensión	120 V ~
Frecuencia	60 Hz
Flujo de aire	4.35 CFM @ 90 psi - 3.56 CFM @ 115 psi
Amperaje	13 A
Capacidad	75 L
Peso	32 kg

Potencia máxima	3 HP
Potencia nominal	2.5 HP
Presión máxima	115 psi
Velocidad	3,400 RPM
Tensión	220 V ~
Frecuencia	60 Hz
Flujo de aire	6.2 CFM @ 90 psi - 5 CFM @ 115 psi
Amperaje	19 A
Capacidad	94 L
Peso	65 kg

CÓDIGO	PRECIO	INNER
TPAC220V	\$ 6,370.00	1

CÓDIGO	PRECIO	INNER
TPAC325	\$ 9,430.00	1

El aspecto, empaque, inner o master de los productos puede variar sin previo aviso debido a la innovación continua de nuestras marcas.

### Compresor portátil

Tensión máxima 12 V~  
150 psi

Para uso en llantas de neumáticos, bicicletas, juguetes inflables, etc.

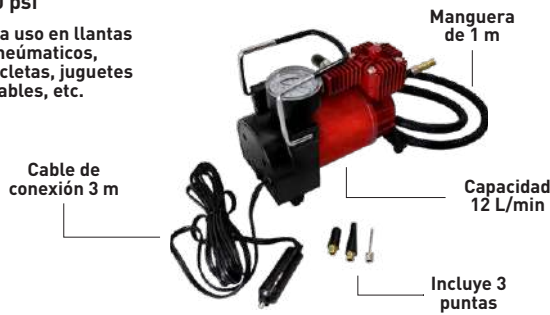

CÓDIGO	PRECIO	INNER	MASTER
TPCP1116	\$ 750.00	1	12

### Juego de accesorios neumáticos 17 piezas

- CONTIENE**
- 1 Pistola para sopletear
  - 1 Inflador cabeza doble
  - 2 Niples tipo "MM" de 1/4"
  - 1 Adaptador para pistola de aire
  - 1 Boquilla de punta alta presión
  - 1 Cople tipo "FF" de 1/4"
  - 2 Conectores rápidos tipo "F"
  - 4 Conectores rápidos tipo "M"
  - 1 Medidor de presión
  - 1 Inflador punta espiga
  - 1 Válvula para inflar balones
  - 1 Cople rápido tipo "F"



CÓDIGO	PRECIO	INNER	MASTER
TPJA1161	\$ 260.00	6	24

### Manguera espiral para compresor 1/4"

Cuerpo de polietileno  
250 lb Máximas de presión

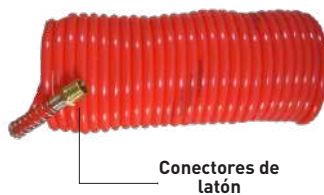

CÓDIGO	DESC.	PRECIO	INNER	MASTER
TPRH1425E	25 ft (7.5 m)	\$ 80.00	1	50
TPRH1450E	50 ft (15 m)	\$ 128.00	1	25

### Juego de pistola para sopletear con boquillas



CÓDIGO	PRECIO	INNER	MASTER
TPPS475	\$ 97.00	12	48

### Pistola para sopletear de aluminio Conexión 1/4" NPT

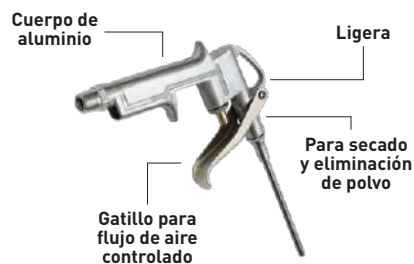

CÓDIGO	PRECIO	INNER	MASTER
TPPS1162	\$ 66.00	6	36

### Pistola para sopletear Conexión 1/4" NPT

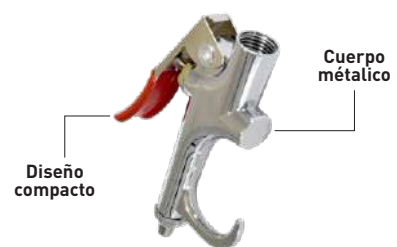

CÓDIGO	PRECIO	INNER	MASTER
TPABG	\$ 62.00	12	72

### Juego de accesorios para manguera 18 piezas

- CONTIENE**
- 1 Pistola para sopletear
  - 1 Adaptador para válvula
  - 1 Válvula diagonal
  - 2 Pivotes
  - 1 Inflador punta espiga
  - 1 Cepillo escobillón
  - 1 Válvula para inflar balones
  - 1 Cálibrador de presión
  - 1 Reparador de válvula
  - 1 Niple tipo "MM" de 1/4"
  - 1 Boquilla aspersiona
  - 1 Boquilla cónica de latón con plástico
  - 1 Conector rápido tipo "M" macho
  - 1 Conector rápido tipo "F" hembra
  - 1 Inflador cabeza doble hembra
  - 1 Boquilla de punta alta presión
  - 1 Cople rápido tipo "F" hembra



CÓDIGO	PRECIO	INNER	MASTER
TPPAS18B	\$ 230.00	12	24

### Juego de accesorios para aire 14 piezas

- CONTIENE**
- 1 Pistola para sopletear
  - 2 Conectores rápidos macho
  - 2 Conectores rápidos hembra
  - 2 Coples rápidos hembra
  - 1 Inflador para neumáticos
  - 1 Boquilla cónica
  - 1 Niple hembra / hembra
  - 1 Niple macho / macho
  - 1 Válvula para inflar balones
  - 1 Reductor para válvula
  - 1 Manguera de resorte 7.5 m



CÓDIGO	PRECIO	INNER	MASTER
TPAA471	\$ 340.00	6	12

### Manguera de uso rudo para compresor

300 psi



CÓDIGO	DESC.	PRECIO	INNER	MASTER
TPAH3825Y	25 ft (7.5 m)	\$ 300.00	1	10
TPAH3850Y	50 ft (15 m)	\$ 545.00	1	6
TPAH38100Y	100 ft (30 m)	\$ 1,020.00	1	2

**Juego de conectores rápidos  
4 piezas latón**



Conector rápido tipo "M" con conexión macho de 1/4" NPT

Coples rápidos tipo "M" hembra y macho

Conector rápido tipo "M" con conexión hembra de 1/4" NPT

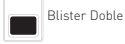

CÓDIGO	PRECIO	INNER	MASTER
TPQCS4	\$ 170.00	12	72

**Juego de conectores rápidos  
5 piezas acero cromado**



1 Cople rápido hembra 1/4" NPT

1 Conector rápido hembra 1/4" NPT

3 Conector rápido macho 1/4" NPT



CÓDIGO	PRECIO	INNER	MASTER
TPJC565	\$ 75.00	12	72

**Cople macho 1/4" NPT acero cromado**

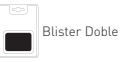

CÓDIGO	PRECIO	INNER	MASTER
TPCRM560	\$ 48.00	12	144

**Conector rápido universal hembra  
1/4" NPT latón**

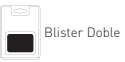

CÓDIGO	PRECIO	INNER	MASTER
TPCR472	\$ 75.00	12	144

**Niple macho/macho universal  
1/4" NPT acero cromado**



CÓDIGO	PRECIO	INNER	MASTER
TPNM473	\$ 17.00	12	144

**Juego de conectores rápidos  
4 piezas acero cromado**



Conector rápido tipo "M" con conexión macho de 1/4" NPT

Coples rápidos tipo "M" hembra y macho

Conector rápido tipo "M" con conexión hembra de 1/4" NPT



CÓDIGO	PRECIO	INNER	MASTER
TPJC564	\$ 107.00	12	72

**Juego de conectores rápidos  
5 piezas latón**



1 Cople rápido hembra 1/4" NPT

1 Conector rápido hembra 1/4" NPT

3 Conector rápido macho 1/4" NPT



CÓDIGO	PRECIO	INNER	MASTER
TPQCS5B	\$ 125.00	12	72

**Cople hembra 1/4" NPT latón**

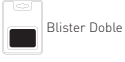

CÓDIGO	PRECIO	INNER	MASTER
TPCOPF	\$ 66.00	12	144

**Conector rápido hembra NPT 1/4" latón**



CÓDIGO	PRECIO	INNER	MASTER
TPCNTF	\$ 25.00	12	144

**Conector rápido macho NPT 1/4" latón**

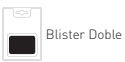

CÓDIGO	PRECIO	INNER	MASTER
TPCNTM	\$ 25.00	12	144

**Juego de conectores rápidos  
5 piezas zinc**



1 Cople rápido hembra 1/4" NPT

1 Conector rápido hembra 1/4" NPT

3 Conector rápido macho 1/4" NPT



CÓDIGO	PRECIO	INNER	MASTER
TPQCS5	\$ 75.00	12	72

**Cople macho 1/4" NPT latón**



CÓDIGO	PRECIO	INNER	MASTER
TPCOPM	\$ 70.00	12	144

**Cople hembra 1/4" NPT acero cromado**

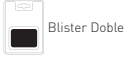

CÓDIGO	PRECIO	INNER	MASTER
TPCRF561	\$ 50.00	12	144

**Conector rápido hembra NPT 1/4" acero cromado**

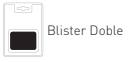

CÓDIGO	PRECIO	INNER	MASTER
TPCRF562	\$ 15.00	12	144

**Conector rápido macho NPT 1/4" acero cromado**

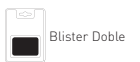

CÓDIGO	PRECIO	INNER	MASTER
TPCRM563	\$ 15.00	12	144

El aspecto, empaque, inner o master de los productos puede variar sin previo aviso debido a la innovación continua de nuestras marcas.



## Pistola para pintar baja presión

Tamaño de entrada: 1/4" NPT  
50 psi



CÓDIGO	PRECIO	INNER	MASTER
TPSG1L	\$ 330.00	1	10

## Pistola para pintar alta presión

Tamaño de entrada: 1/4" NPT

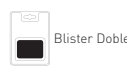

CÓDIGO	PRECIO	INNER	MASTER
TPSG1DB	\$ 580.00	1	10

## Pistola para pintar de retoque

Tamaño de entrada: 1/4" NPT



CÓDIGO	PRECIO	INNER	MASTER
TPTUG1DB	\$ 410.00	1	12

## Pistola de gravedad HVLP

Tamaño de entrada: 1/4" NPT



CÓDIGO	PRECIO	INNER	MASTER
TPSGG14C	\$ 660.00	1	10

## Pistola de gravedad con manómetro HVLP

Tamaño de entrada: 1/4" NPT

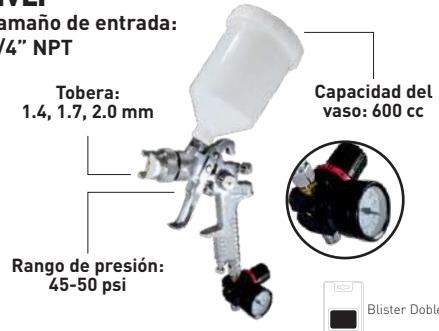

CÓDIGO	PRECIO	INNER	MASTER
TPSGGFH906K	\$ 1050.00	1	5

## Pistola tirolera neumática

Tamaño de entrada: 1/4" NPT  
Capacidad del depósito: 5.48 L



CÓDIGO	PRECIO	INNER	MASTER
TPAHGPC	\$ 770.00	1	6

## Bote metálico para pistola de baja presión



CÓDIGO	PRECIO	INNER	MASTER
TPSG1LB	\$ 107.00	1	10

## Bote plástico para pistola de gravedad



CÓDIGO	PRECIO	INNER	MASTER
TPSGG14CB	\$ 99.00	1	50

## Bote metálico para pistola de alta presión



CÓDIGO	PRECIO	INNER	MASTER
TPSG1DBB	\$ 105.00	1	10

## Destorcedor de manguera de aluminio 1/4" NPT

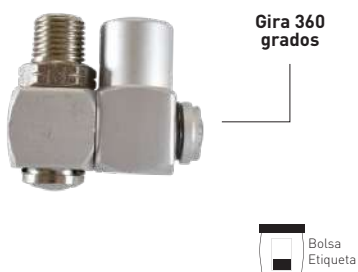

CÓDIGO	PRECIO	INNER	MASTER
TPDM474	\$ 85.00	12	144

## Regulador de aire con manómetro 1/4" NPT

160 psi

Para ser utilizado con la mayoría de las herramientas neumáticas



CÓDIGO	PRECIO	INNER	MASTER
TPRA476	\$ 140.00	10	60

## Filtro separador de agua y aceite 1/4" NPT



CÓDIGO	PRECIO	INNER	MASTER
TPFS477	\$ 115.00	6	24

**Chuck inflador manguera con manómetro**  
140 psi



CÓDIGO	PRECIO	INNER	MASTER
TPAT102	\$ 165.00	12	24

**Inflador aire manguera uso rudo**  
120 psi



CÓDIGO	PRECIO	INNER	MASTER
TPAT1120G	\$ 275.00	12	24

**Pistola lava motores baja presión**



CÓDIGO	PRECIO	INNER	MASTER
TPEGC	\$ 250.00	12	24

**Juego de reparación para manguera latón 6 piezas**

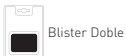

CÓDIGO	PRECIO	INNER	MASTER
TPAHRK6	\$ 90.00	12	72

**Chuck inflador sencillo**

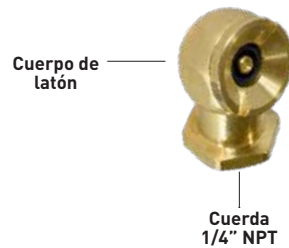

CÓDIGO	PRECIO	INNER	MASTER
TPTC1	\$ 40.00	24	144

**Chuck inflador bola**

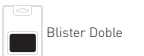
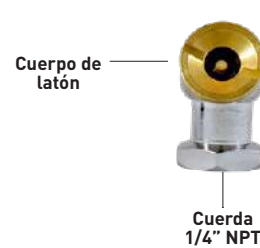

CÓDIGO	PRECIO	INNER	MASTER
TPIB327	\$ 42.00	24	144

**Medidor de presión cabeza sencilla**



CÓDIGO	PRECIO	INNER	MASTER
TPMP1137	\$ 65.00	12	72

**Medidor de presión cabeza doble**

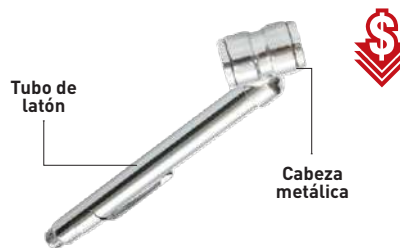

CÓDIGO	PRECIO	INNER	MASTER
TPMP1136	\$ 75.00	12	72

**Chuck inflador de aire doble boca**

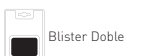

CÓDIGO	PRECIO	INNER	MASTER
TPDHTC	\$ 55.00	12	48

**Medidor de presión cabeza doble**  
160 psi



CÓDIGO	PRECIO	INNER	MASTER
TPDFTG160	\$ 155.00	12	48

**Parche para cámara 48 piezas**



CÓDIGO	PRECIO	INNER	MASTER
TP185	\$ 25.00	10	200

**Aguja para inflar balones**  
100 piezas



CÓDIGO	PIEZA	BOLSA	INNER	MASTER
TPINEED100	\$ 1.25	\$ 125.00	10	100

El aspecto, empaque, inner o master de los productos puede variar sin previo aviso debido a la innovación continua de nuestras marcas.

## Kit de reparación para pistola de baja presión



CÓDIGO	PRECIO	INNER	MASTER
TPSG1LK	\$ 170.00	1	10

## Cámara para llanta de bicicleta 2.125"



CÓDIGO	DESC.	PRECIO	INNER	MASTER
TPCPB1861	20"	\$ 55.00	1	50
TPCPB1860	24"	\$ 57.00	1	50
TPCPB1859	26"	\$ 59.00	1	50

## Kit de reparación para pistola de alta presión

- CONTIENE**
- 1 Boquilla
  - 1 Aguja
  - 1 Resorte
  - 1 Tobera
  - 1 Tuerca
  - 1 Cuerpo de regulador
  - 1 Tubo de succión
  - 1 Regulador de caudal



CÓDIGO	PRECIO	INNER	MASTER
TPSG1DBK	\$ 215.00	1	10

## Llanta bicicleta 2.125"



CÓDIGO	DESC.	PRECIO	INNER	MASTER
TPLL1865	20"	\$ 105.00	1	25
TPLL1864	24"	\$ 125.00	1	25
TPLL1863	26"	\$ 135.00	1	25

## Kit de reparación p/pistola de gravedad

- CONTIENE**
- 1 Boquilla
  - 1 Aguja
  - 1 Resorte
  - 1 Punta de fluido
  - 1 Anillo slip
  - 1 Buje
  - 1 Separador de aire
  - 1 Sello separador de aire



CÓDIGO	PRECIO	INNER	MASTER
TPSG614CK	\$ 347.00	1	10

## Bomba para inflar balones Manguera y aguja incluidos

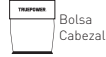

CÓDIGO	PRECIO	INNER	MASTER
TPHP300T	\$ 35.00	10	100

## Bomba de aire de pie 100 psi

Pistón metálico



CÓDIGO	PRECIO	INNER	MASTER
TPFT100M	\$ 90.00	1	20

## Bomba de aire de mano 20" 116 psi



CÓDIGO	PRECIO	INNER	MASTER
TPHP20112C	\$ 110.00	1	20

## Mini bomba para bicicleta 60 psi

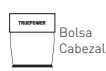

CÓDIGO	PRECIO	INNER	MASTER
TPBM505	\$ 122.00	12	48

## Bomba de aire de mano 20" x 1 3/8" 116 psi



CÓDIGO	PRECIO	INNER	MASTER
TPBM20138	\$ 120.00	10	20

## Bomba de aire de mano 38" 116 psi



CÓDIGO	PRECIO	INNER	MASTER
TPBM1857	\$ 140.00	6	12

## Bomba de aire de mano 20" x 1 3/4" 116 psi

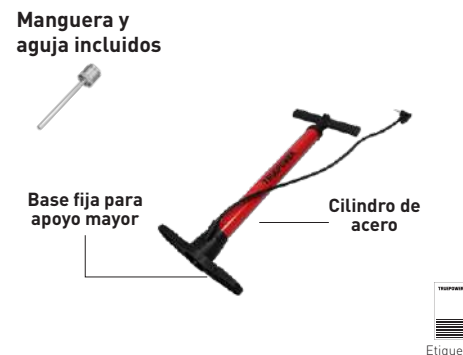

CÓDIGO	PRECIO	INNER	MASTER
TPB356	\$ 160.00	5	10

El aspecto, empaque, inner o master de los productos puede variar sin previo aviso debido a la innovación continua de nuestras marcas.



# CLAVADORAS Y ENGRAPADORAS

## Engrapadora uso rudo tipo T-50 5/32" - 9/16"

Cuerpo metálico muy resistente  
 Profundidad ajustable: 6 mm, 10 mm y 12 mm  
 Compatible con grapas de 1/4", 5/16", 3/8", 1/2", y 9/16"  
 Incluye: 500 grapas 1/2" y 500 grapas 5/16"



CÓDIGO	PRECIO	INNER	MASTER
TEUR592	\$ 345.00	5	20

## Grapas estándar tipo T-50 1000 piezas



CÓDIGO	DESC.	PRECIO	INNER	MASTER
TPGR14	1/4"	\$ 20.00	1	40
TPGR516	5/16"	\$ 20.00	1	40
TPGR38	3/8"	\$ 20.00	1	40
TPGR12	1/2"	\$ 24.00	1	40
TPGR916	9/16"	\$ 30.00	1	40

## Engrapadora neumática calibre 18

Mango ergonómico  
 Gama de grapas: 1/4" - 1 5/8"  
 Entrada de aire: 1/4"  
 Cuerpo de aluminio  
 Capacidad 100 grapas  
 Presión de trabajo: 70 - 110 psi



CÓDIGO	PRECIO	INNER	MASTER
TP9040A	\$ 1100.00	1	10

## Clavo para clavadora neumática 5000 pzas.

Calibre 18



CÓDIGO	DESC.	PRECIO	INNER	MASTER
TPCN1071	3/8"	\$ 37.00	1	24
TPCN1072	1/2"	\$ 45.00	1	24
TPCN1073	5/8"	\$ 51.00	1	24
TPCN1074	3/4"	\$ 70.00	1	12
TPCN1075	1"	\$ 95.00	1	12
TPCN1076	1 3/16"	\$ 99.00	1	12
TPCN1077	1 1/4"	\$ 115.00	1	12
TPCN1078	1 3/8"	\$ 120.00	1	12
TPCN1079	1 5/8"	\$ 145.00	1	6
TPCN1080	1 3/4"	\$ 150.00	1	6
TPCN1081	2"	\$ 165.00	1	6

## Clavadora neumática calibre 18

Mango ergonómico  
 Gama de clavos: 3/8" - 2"  
 Entrada de aire: 1/4"  
 Peso: 1.4 kg  
 Capacidad de 100 clavos  
 Cuerpo de aluminio  
 Incluye aceite lubricante, lentes de protección y llaves Allen



CÓDIGO	PRECIO	INNER	MASTER
TPF50A	\$ 1,130.00	1	10

## Grapa para engrapadora neumática 5000 pzas.

Calibre 18



CÓDIGO	DESCRIPCIÓN	PRECIO	INNER	MASTER
TPGN1082	1/4" x 13 mm	\$ 95.00	1	12
TPGN1083	1/4" x 16 mm	\$ 125.00	1	12
TPGN1084	1/4" x 19 mm	\$ 140.00	1	6
TPGN1085	1/4" x 22 mm	\$ 157.00	1	6
TPGN1086	1/4" x 25 mm	\$ 176.00	1	6
TPGN1087	1/4" x 28 mm	\$ 190.00	1	6
TPGN1088	1/4" x 32 mm	\$ 213.00	1	6
TPGN1089	1/4" x 35 mm	\$ 242.00	1	6
TPGN1090	1/4" x 38 mm	\$ 266.00	1	4
TPGN1091	1/4" x 40 mm	\$ 270.00	1	4

# HERRAMIENTA DE CARGA



## Diablito de carga 400 lbs

Carga máxima: 180 Kg



## Diablo de aluminio plegable 100 kg

### CARACTERÍSTICAS

Carga máxima	100 kg
Altura máxima	1 m
Altura mínima	0.63 m
Peso	2.9 kg



Agarradera ergonómica

Mangos telescópicos

Llantas de 5"

Llantas de TPR y polipropileno



CÓDIGO	PRECIO	INNER
TPHT	\$ 1,200.00	1

CÓDIGO	PRECIO	INNER	MASTER
TPDP1163	\$ 780.00	1	4

## Cámara para llanta neumática



## Llanta repuesto para diablito 10"



## Llanta sola para carretilla 4 capas reforzada 16" X 4"



CÓDIGO	DESC.	PRECIO	INNER	MASTER
TPTUB10	Diablito 10"	\$ 38.00	1	100
TPTUB16	Carretilla 16"	\$ 45.00	1	50

CÓDIGO	PRECIO	INNER	MASTER
TPHTS	\$ 75.00	1	20

CÓDIGO	PRECIO	INNER	MASTER
TPAT16	\$ 145.00	1	15

## Llanta completa para diablito 10"



Cuerpo metálico



## Llanta imponchable para carretilla 16" X 4"

Suave y ligera  
Larga duración  
100% poliuretano  
Mejor amortiguamiento  
Facilita el acarreo



## Llanta inflable completa para carretilla 16" X 4" 4 Capas reforzada



Cuerpo metálico



CÓDIGO	PRECIO	INNER	MASTER
TPHT10	\$ 155.00	1	5

CÓDIGO	PRECIO	MASTER
TPLI779	\$ 460.00	1

CÓDIGO	PRECIO	INNER	MASTER
TPAT164	\$ 310.00	1	5

## Carretilla 80 L (5.5 ft³) llanta neumática reforzada 16" x 4"

Alambre plastificado Calibre 21  
Tacón estabilizador

Soportes de uso pesado resistentes hasta 530 kg



## Carretilla 65 L (4.5 ft³) llanta neumática reforzada 16" x 4"

Alambre plastificado Calibre 21  
Tacón estabilizador

Producto **NUEVO**  
Soportes de uso pesado resistentes hasta 450 kg

Producto sujeto a disponibilidad\*



CÓDIGO	PRECIO	MASTER
TPCR778	\$ 1,168.00	1

CÓDIGO	PRECIO	MASTER
TP1065	\$ 1,140.00	1

HERRAMIENTA DE CARGA

El aspecto, empaque, inner o master de los productos puede variar sin previo aviso debido a la innovación continua de nuestras marcas.

**Soldadora inversora**

- Mayor confiabilidad y calidad de soldadura
- Más eficiencia energética
- Tecnología IGBT

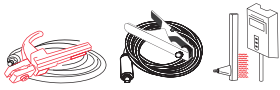

Incluye: Cables para soldar con pinza a tierra y portaelectrodo, máscara y cepillo.



**MMA 120 A**  
120 V~



**NOM**

**Soldadora inversora**

- Mayor confiabilidad y calidad de soldadura
- Más eficiencia energética

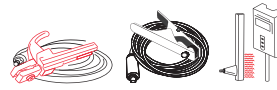

Incluye: Cables para soldar con pinza a tierra y portaelectrodo, máscara y cepillo.



**MMA 200 A**  
120/230 V~

**NOM**

**CICLO DE TRABAJO**

**35% 120 A**

3.5 min trabajo x 6.5 min de descanso

Peso: 5 kg

1 Fase

Corriente de salida directa

**CÓDIGO**

**PRECIO**

**MASTER**

TP1003

\$ 3,400.00

1

**Soldadora de arco eléctrico**

- Mayor confiabilidad y calidad de soldadura
- Más eficiencia energética

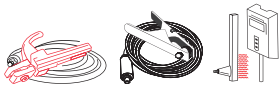

Incluye: Cables para soldar con pinza a tierra y portaelectrodo, máscara y cepillo.



**MMA 100 A**  
120 V~

**NOM**

**Soldadora de arco eléctrico**

- Mayor confiabilidad y calidad de soldadura
- Más eficiencia energética

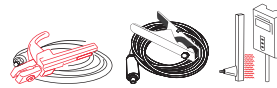

Incluye: Cables para soldar con pinza a tierra y portaelectrodo, máscara y cepillo.



**MMA 250 A**  
120/230 V~

**NOM**

**CICLO DE TRABAJO**

**10% 100 A**

1 min trabajo x 9 min de descanso

Peso: 10 kg

1 Fase

Corriente de salida directa

**CÓDIGO**

**PRECIO**

**MASTER**

TP1005

\$ 2,700.00

1

**Soldadora inversora para electrodo y TIG**

- Para electrodo y microalambre
- Mayor confiabilidad y calidad de soldadura
- Más eficiencia energética



Cables para soldar con pinza a tierra (1.5 m), portaelectrodo (2 m) y antorcha con cable (TIG, 4 m), máscara y cepillo.



**TIG + MMA 200 A**  
120/230 V~

**NOM**

**Soldadora microalambre**

- No utiliza gas
- Mayor confiabilidad
- Mayor calidad de soldadura
- Más eficiencia energética



Incluye: Cables con pinza a tierra, antorcha, máscara y cepillo.



**MIG 120 A**  
120 V~

**NOM**

**CICLO DE TRABAJO**

**50% 200 A**

5 min trabajo x 5 min de descanso

Peso: 11 kg

**80% 150 A**

8 min trabajo x 2 min de descanso

Peso: 11 kg

**CÓDIGO**

**PRECIO**

**MASTER**

TP1007

\$ 12,000.00

1

**CICLO DE TRABAJO**

**15% 105 A**

1.5 min trabajo x 8.5 min de descanso

Peso: 17 kg

**CÓDIGO**

**PRECIO**

**MASTER**

TP1008

\$ 4,500.00

1

El aspecto, empaque, inner o master de los productos puede variar sin previo aviso debido a la innovación continua de nuestras marcas.

### Soldadora corriente alterna 185 A



Incluye: Cable con portaelectrodo de 3 m, pinza para tierra de 2 m



Carga		Alimentación	
Tensión Máx. Cto. Abierto	62	Tensión de alimentación	127 V ~
Tensión nominal (V)	28	Corriente (A)	110 / 65
Corriente nominal	185	Factor de potencia (%)	65
% de C.T. Nominal	15	Potencia real (KW)	10
% de C.T. A.I. Máx.	15	Eficiencia (%)	75
Corriente al 100% C.T.	100	Frecuencia Hz	60 Hz
Gama de selección I	75 - 185	Clase de aislamiento	F (155° C)
Peso de la máquina	25 kg	Fase	1

CÓDIGO	DESCRIPCIÓN	PRECIO	INNER
TPS185A	127 V~ / 1 / 60 Hz 185 A / 28 V / 10%	\$ 2,800.00	1

### Soldadora corriente alterna 225 A



Incluye: Cable con portaelectrodo de 3 m, pinza para tierra de 2 m



Primario		Secundario	
Ampers	5 - 17	Ampers	225
Volts	110 - 220 V ~	Volts	28
Factor potencia	0.6	Ciclos	60
KW	3.05	Peso de la máquina	45 kg
		Frecuencia Hz	60 Hz

CÓDIGO	DESCRIPCIÓN	PRECIO	INNER
TPS225A	110 / 220 V~ / 60 Hz 225 A / 28 V / 10%	\$ 3,600.00	1

### Soldadora corriente alterna 300 A



Incluye: Cable con portaelectrodo de 3 m, pinza para tierra de 2 m



### Soldadora corriente alterna 200 A



Incluye: Cable con portaelectrodo de 3 m, pinza para tierra de 2 m



Carga		Alimentación	
Tensión Máx. Cto. Abierto	62	Tensión de alimentación	127 V ~
Tensión nominal (V)	28	Corriente (A)	110 / 65
Corriente nominal	200	Factor de potencia (%)	65
% de C.T. Nominal	20	Potencia real (KW)	10
% de C.T. A.I. Máx.	20	Eficiencia (%)	75
Corriente al 100% C.T.	100	Frecuencia Hz	60 Hz
Gama de selección I	50 - 200	Clase de aislamiento	F (155° C)
Peso de la máquina	35 kg	Fase	1

CÓDIGO	DESCRIPCIÓN	PRECIO	INNER
TPS200A	127 V~ / 1 / 60 Hz 200 A / 28 V / 10%	\$ 3,050.00	1

### Soldadora corriente alterna 250 A



Incluye: Cable con portaelectrodo de 3 m, pinza para tierra de 2 m



Carga		Alimentación	
Tensión Máx. Cto. Abierto	62	Tensión de alimentación	127 / 220 V ~
Tensión nominal (V)	30	Corriente (A)	110 / 65
Corriente nominal	250	Factor de potencia (%)	65
% de C.T. Nominal	20	Potencia real (KW)	10
% de C.T. A.I. Máx.	20	Eficiencia (%)	75
Corriente al 100% C.T.	125	Frecuencia Hz	60 Hz
Gama de selección I	50 - 250	Clase de aislamiento	F (155° C)
Peso de la máquina	55 kg	Fase	1

CÓDIGO	DESCRIPCIÓN	PRECIO	INNER
TPS250A	127 / 220 V~ / 1 / 60 Hz 250 A / 30 V / 10%	\$ 4,250.00	1

Carga		Alimentación	
Tensión Máx. Cto. Abierto	62	Tensión de alimentación	127 / 220 V ~
Tensión nominal (V)	32	Corriente (A)	110 / 65
Corriente nominal	300	Factor de potencia (%)	65
% de C.T. Nominal	20	Potencia real (KW)	10
% de C.T. A.I. Máx.	20	Eficiencia (%)	75
Corriente al 100% C.T.	150	Frecuencia Hz	60 Hz
Gama de selección I	50 - 300	Clase de aislamiento	F (155° C)
Peso de la máquina	60 kg	Fase	1

CÓDIGO	DESCRIPCIÓN	PRECIO	INNER
TPS300A	127 / 220 V~ / 1 / 60 Hz 300 A / 32 V / 10%	\$ 4,700.00	1

**Electrodo 6013**

Para estructuras ligeras

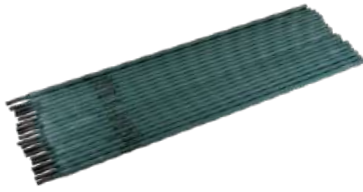

CARACTERÍSTICAS	
Tipo de corriente	CA/CD
Medida	Amperes requeridos
3/32"	40-90 A
1/8"	80-130 A
5/32"	110-165 A
Empaque	5 kg



CÓDIGO	DESC.	PRECIO POR kg	INNER	MASTER
TPE1150	3/32" (2.5 mm)	\$ 62.00	5	20
TPE1151	1/8" (3.2 mm)	\$ 62.00	5	20
TPE1152	5/32" (4.0 mm)	\$ 62.00	5	20

**Juego de cables para soldar**

1 Pinza para electrodo con cable #4 AWG 3 m  
1 Pinza para tierra con cable #4 AWG 2 m



CÓDIGO	PRECIO	INNER	MASTER
TPJC1200	\$ 620.00	1	15

**Pinza portaelectrodo**

Excelente conductividad por su alto contenido de aleación de cobre  
Cubierta aislante y resistente de fibra de vidrio



CÓDIGO	DESCRIPCIÓN	PRECIO	INNER	MASTER
TPPE1155	300 Amperes	\$ 150.00	1	50
TPPE1156	500 Amperes	\$ 175.00	1	30

**Pinza para tierra**

Resistente a corrosión  
Mordazas curvas de aleación de cobre  
Acabado Cromado



CÓDIGO	DESCRIPCIÓN	PRECIO	INNER	MASTER
TPPT1153	300 Amperes	\$ 90.00	1	36
TPPT1154	500 Amperes	\$ 124.00	1	36

**Vidrio de careta para soldar**



CÓDIGO	SOMBRA	PRECIO	INNER	MASTER
TPV010	No. 10	\$ 6.50	100	400
TPV012	No. 12	\$ 6.50	100	400
TPV014	No. 14	\$ 6.50	100	400

**Lentes para soldar**

Lente abatible  
4 Válvulas de ventilación



Sombra 6



CÓDIGO	PRECIO	INNER	MASTER
TPWG2	\$ 48.00	30	120

**Lentes de soldar flexibles**

Autoaplicación para soldadura autogena  
Para corte y soldar



Sombra 6



CÓDIGO	PRECIO	INNER	MASTER
TPLSF333	\$ 57.00	10	200

**Careta para soldar**



Lente abatible

Lente sombra Din 10



CÓDIGO	PRECIO	INNER	MASTER
TPAHP	\$ 80.00	1	25

**Careta electrónica para soldar**

CARACTERÍSTICAS	
Aplicaciones	Arc, smaw, tig, mig, Mag gtaw, saw, soldadura de gas
Escala de oscurecimiento	Din #3 (antes de soldar) Din #9#13 (soldando)
Velocidad de oscurecimiento	1/25000 s
Área de vista	92 x 42 mm
Sistema de alimentación	Celdas solares



CÓDIGO	DESC.	PRECIO	INNER	MASTER
TPWHA	Acabado negro	\$ 900.00	1	4
TPW1810	Diseño de fuego	\$ 1,100.00	1	4



## Hilo albañil blanco



CÓDIGO	DESC.	PRECIO	INNER	MASTER
TPHA1361	65 m	\$ 15.00	1	360
TPHA1360	165 m	\$ 25.00	1	198

## Hilo albañil de color 65 m



CÓDIGO	DESC.	PRECIO	INNER	MASTER
TPHA1362	Amarillo	\$ 15.00	1	360
TPHA1363	Azul	\$ 15.00	1	360
TPHA1364	Naranja	\$ 15.00	1	360
TPHA1365	Rojo	\$ 15.00	1	360
TPHA1366	Verde	\$ 15.00	1	360

## Polvo para tiralíneas 226 g

Gis de alta visibilidad



CÓDIGO	DESC.	PRECIO	INNER	MASTER
TPPT325	Rojo	\$ 23.00	6	36
TPPT326	Azul	\$ 23.00	6	36

## Juego de tiralíneas con polvo 30 m



CÓDIGO	PRECIO	INNER	MASTER
TPTP463	\$ 70.00	12	48

## Juego de tiralíneas profesional con polvo 30 m



CÓDIGO	PRECIO	INNER	MASTER
TPCLR100MC	\$ 90.00	10	50

## Porta crayón para metal



CÓDIGO	PRECIO	INNER	MASTER
TPPC1273	\$ 69.00	1	500

## Crayón para metal paquete 10 piezas



CÓDIGO	PIEZA	BOLSA	INNER	MASTER
TPCM1272	\$ 7.00	\$ 70.00	1	144

## Lápiz bicolor para madera rojo / azul paquete 10 piezas



CÓDIGO	PIEZA	BOLSA	INNER	MASTER
TPLB1271	\$ 8.20	\$ 82.00	1	250

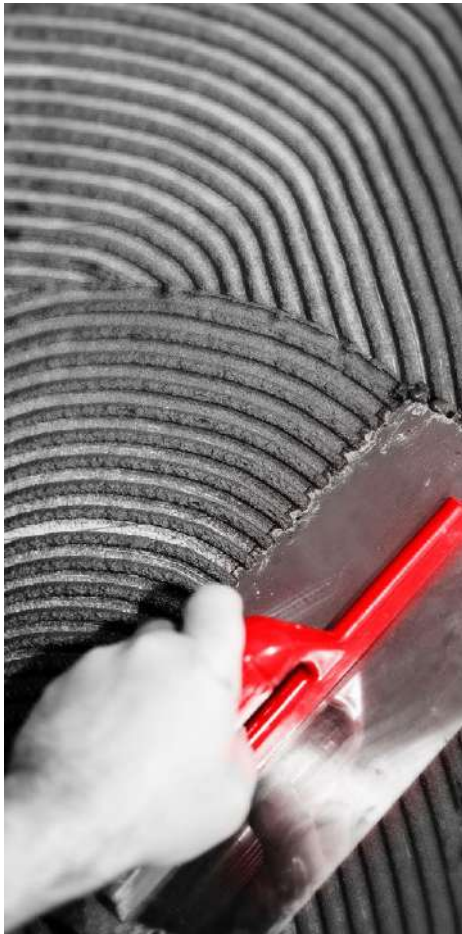

**Llana mango de madera 11" x 5"**

Uso profesional  
10 Remaches



Pata de aluminio pulido



CÓDIGO	DESCRIPCIÓN	PRECIO	INNER	MASTER
TPLL334	Borde recto	\$ 110.00	6	60
TPLL335	Borde dentado	\$ 110.00	6	60
TPLL336	Borde cuadrado	\$ 110.00	6	60

**Llana mango de ABS 11" x 5"**

6 Remaches



Hoja metálica



CÓDIGO	DESCRIPCIÓN	PRECIO	INNER	MASTER
TPLL337	Borde recto	\$ 70.00	6	60
TPLL338	Borde dentado	\$ 70.00	6	60
TPLL339	Borde cuadrado	\$ 70.00	6	60

**Flota de esponja acabado fino**

Mango de madera



**Flota de esponja acabado aspero**

Mango de madera



CÓDIGO	DESCRIPCIÓN	PRECIO	INNER	MASTER
TPFE346	9 1/2" x 4" x 7/16"	\$ 70.00	10	50

CÓDIGO	DESCRIPCIÓN	PRECIO	INNER	MASTER
TPFE568	9 1/2" x 4" x 3/4"	\$ 100.00	10	50

**Cuchara para albañil**



Dureza 44 a 50 HRC



CÓDIGO	DESC.	PRECIO	INNER	MASTER
TPCA292	6"	\$ 46.00	12	60
TPCA293	9"	\$ 55.00	12	60
TPCA294	10"	\$ 62.00	12	60
TPCA295	11"	\$ 65.00	12	60

**Volteador de aluminio**

Fundido de aleación de aluminio 380



CÓDIGO	PRECIO	INNER	MASTER
TPV385	\$ 99.00	6	36

**Rayador de aluminio**

Fundido de aleación de aluminio 380



CÓDIGO	PRECIO	INNER	MASTER
TPR384	\$ 95.00	6	36

El aspecto, empaque, inner o master de los productos puede variar sin previo aviso debido a la innovación continua de nuestras marcas.

## Espátula de acero flexible

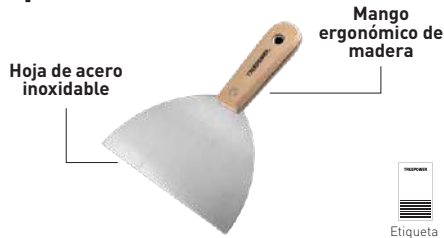

CÓDIGO	DESC.	PRECIO	INNER	MASTER
TPEAM482	1"	\$ 35.00	12	240
TPEAM483	2"	\$ 40.00	12	240
TPEAM484	3"	\$ 45.00	12	240
TPEAM485	4"	\$ 50.00	12	240
TPEAM486	5"	\$ 55.00	12	240
TPEAM487	6"	\$ 65.00	12	240

## Espátula de plástico flexible



CÓDIGO	DESC.	PRECIO	INNER	MASTER
TPPK1	1"	\$ 19.00	12	240
TPPK2	2"	\$ 21.00	12	240
TPPK3	3"	\$ 22.00	12	240
TPPK4	4"	\$ 26.00	12	240
TPPK5	5"	\$ 29.00	12	240

## Juego de cuñas 9.5 cm de largo 4 piezas

Medidas: 5, 9.8, 7.8 y 11.8 cm

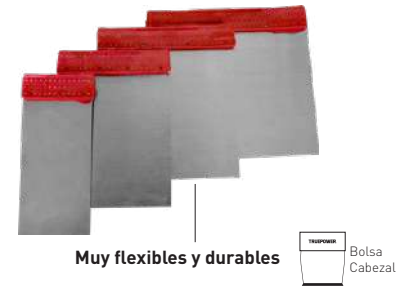

CÓDIGO	PRECIO	INNER	MASTER
TPJE600	\$ 32.00	24	96

## Espátula tapizadora



CÓDIGO	DESC.	PRECIO	INNER	MASTER
TPEP601	8"	\$ 86.00	10	80
TPEP602	10"	\$ 105.00	10	80
TPEP603	12"	\$ 110.00	10	80

## Espátula de 8" 3 posiciones



CÓDIGO	PRECIO	INNER	MASTER
TPSCR8	\$ 71.00	24	36

## Contador manual mecánico

4 Dígitos



CÓDIGO	PRECIO	INNER	MASTER
TPCM612	\$ 50.00	12	48

## Cinta larga de fibra de vidrio

Espesor: 0.47 mm

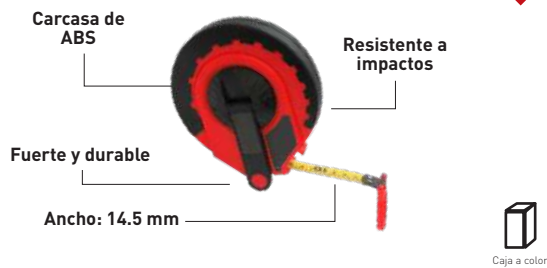

CÓDIGO	DESC.	PRECIO	INNER	MASTER
TPCF1214	20 m	\$ 165.00	6	24
TPCF1215	30 m	\$ 240.00	6	24
TPCF1216	50 m	\$ 340.00	6	24

## Cinta larga metálica

Espesor: 0.18 mm

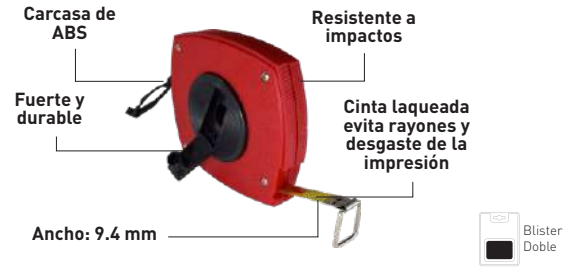

CÓDIGO	DESC.	PRECIO	INNER	MASTER
TPCM1217	20 m	\$ 170.00	6	36
TPCM1218	30 m	\$ 225.00	6	36

## Flexómetro metálico



CÓDIGO	DESCRIPCIÓN	PRECIO	INNER	MASTER
TPCM1765	3 m x 19 mm	\$ 58.00	24	120
TPCM1766	5 m x 19 mm	\$ 80.00	24	120
TPCM1767	7.5 m x 25 mm	\$ 155.00	12	72

## Flexómetro seguro automático

Uso rudo



CÓDIGO	DESCRIPCIÓN	PRECIO	INNER	MASTER
TPCM178	3 m x 19 mm	\$ 72.00	12	72
TPCM179	5 m x 19 mm	\$ 90.00	12	72
TPCM180	7.5 m x 25 mm	\$ 150.00	12	48

**Regla 12"**

Escala en pulgadas y cm

Cuerpo de acero inoxidable



CÓDIGO	PRECIO	INNER	MASTER
TPRA609	\$ 60.00	12	72

**Calibrador vernier escolar 5"**

Tolerancia 0.003"

(127 mm)

Fabricado en acero



CÓDIGO	PRECIO	INNER	MASTER
TPCV407	\$ 62.00	6	72



**Calibrador vernier digital 6"**

Display LCD

Varilla de profundidad



Botón de conversión pulgadas a milímetros



CÓDIGO	PRECIO	INNER	MASTER
TPCD1160	\$ 540.00	6	24

**Escuadra para carpintero**

Cuerpo de acero inoxidable

Medidas pulgadas y milímetros

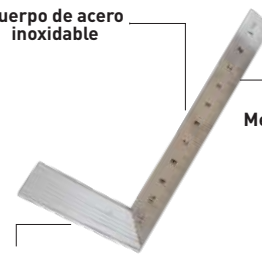

Mango de aluminio robusto



CÓDIGO	DESC.	PRECIO	INNER	MASTER
TPEC607	8"	\$ 85.00	12	36
TPEC608	12"	\$ 105.00	12	36

**Escuadra para cartero**

Gruadación estampada en acero



CÓDIGO	DESC.	PRECIO	INNER	MASTER
TPRCS812	8" X 12"	\$ 70.00	24	96
TPRCS1624	16" X 24"	\$ 160.00	1	24



**Escuadra combinación 12"**

Cuerpo de acero



Mango metálico



CÓDIGO	PRECIO	INNER	MASTER
TPCS12HD	\$ 160.00	6	60

**Escuadra falsa mango plástico**

Regla de acero inoxidable de 1.2 mm de espesor

Incluye 1 gota



Mango plástico

20 cm de longitud



CÓDIGO	PRECIO	INNER	MASTER
TPEF1115	\$ 95.00	6	36

**Nivel torpedo 9" Profesional con imán**

Cuerpo de aluminio



Recubrimiento contra impactos

Puntas "V"



CÓDIGO	PRECIO	INNER	MASTER
TPNT401	\$ 105.00	12	72

**Nivel de aluminio profesional**

Cuerpo de aluminio con protección de ABS

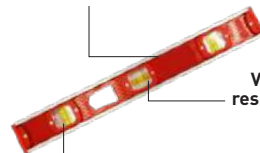

Ventanas resistentes al rayado

Gotas intercambiables



CÓDIGO	DESC.	PRECIO	INNER	MASTER
TPNA402	14"	\$ 85.00	6	36
TPNA403	18"	\$ 110.00	6	36
TPNA404	24"	\$ 144.00	6	36
TPNA405	36"	\$ 220.00	6	24
TPNA406	48"	\$ 280.00	6	12

**Nivel torpedo 9"**

Cuerpo de aluminio

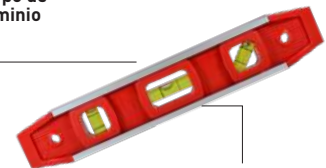

Magnético



CÓDIGO	PRECIO	INNER	MASTER
TPLEVEL9	\$ 43.00	12	72

### Barreta de ña

Sección hexagonal



CÓDIGO	DESC.	PRECIO	INNER	MASTER
TPWB18	18"	\$ 100.00	1	20
TPWB24	24"	\$ 125.00	1	10
TPWB36	36"	\$ 160.00	1	10

### Mazo de hule

Cabeza de neúpreno que no daña superficies



CÓDIGO	DESC.	PRECIO	INNER	MASTER
TPRM8W	8 oz	\$ 34.00	12	48
TPRM16W	16 oz	\$ 50.00	12	24
TPRM24W	24 oz	\$ 67.00	6	24

### Martillo pulido ña recta cabeza fresada

Mango antiderrapante



CÓDIGO	DESC.	PRECIO	INNER	MASTER
TPMR1106	20 oz	\$ 150.00	6	24
TPMR1107	24 oz	\$ 170.00	6	18

### Martillo ña recta 16 oz

Mango de madera



CÓDIGO	PRECIO	INNER	MASTER
TPMR596	\$ 95.00	6	36

### Martillo ña curva 16 oz

Mango de madera



CÓDIGO	PRECIO	INNER	MASTER
TPMM595	\$ 95.00	6	36

### Martillo de bola mango de madera

Mango antiderrapante



CÓDIGO	DESC.	PRECIO	INNER	MASTER
TPMB1100	8 oz	\$ 105.00	6	36
TPMB1101	12 oz	\$ 115.00	6	24
TPMB1102	16 oz	\$ 125.00	6	24
TPMB1103	24 oz	\$ 150.00	6	18
TPMB1104	32 oz	\$ 170.00	6	12

### Martillo de ña curva

Mango de fibra de vidrio



CÓDIGO	DESC.	PRECIO	INNER	MASTER
TPMM488	Mini 10 oz	\$ 100.00	6	24
TPMU489	16 oz	\$ 150.00	6	24

### Martillo de ña curva tubular

Reduce las vibraciones con su mango de neopreno



CÓDIGO	DESC.	PRECIO	INNER	MASTER
TPH16T	16 oz	\$ 130.00	6	36
TPH20T	20 oz	\$ 138.00	6	24

### Martillo de ña recta tubular

Trabajo pesado 20 oz



Mango tubular



Cabeza fresada

Mango de 19"



CÓDIGO	PRECIO	INNER	MASTER
TPMT312	\$ 159.00	6	24

### Marro con mango de madera y protector de plástico 14"

Protector termoplástico que protege contra golpes fallidos y reduce la vibración



CÓDIGO	DESC.	PRECIO	INNER	MASTER
TPM283	2 lb	\$ 145.00	1	24
TPM284	3 lb	\$ 170.00	1	18
TPM285	4 lb	\$ 200.00	1	12

### Marro octagonal con mango de madera 36"

Protector termoplástico que protege contra golpes fallidos y reduce la vibración



Caras maquinadas



CÓDIGO	DESC.	PRECIO	INNER	MASTER
TPM286	6 lb	\$ 340.00	1	6
TPM287	8 lb	\$ 405.00	1	6
TPM288	10 lb	\$ 490.00	1	6
TPM289	12 lb	\$ 600.00	1	6
TPM290	14 lb	\$ 720.00	1	6
TPM291	16 lb	\$ 840.00	1	6

### Mango para marro de madera de encino



CÓDIGO	DESC.	PRECIO	INNER	MASTER
TPMM441	24"	\$ 66.00	1	10
TPMM442	36"	\$ 89.00	1	10

El aspecto, empaque, inner o master de los productos puede variar sin previo aviso debido a la innovación continua de nuestras marcas.

**Tornillo de banco fijo**



Caja a color

CÓDIGO	DESC.	PRECIO	INNER	MASTER
TPTB1435	2"	\$ 190.00	1	20
TPTB1436	3"	\$ 210.00	1	20

**Tornillo de banco giratorio**



Caja a color

CÓDIGO	DESC.	PRECIO	INNER	MASTER
TPTB1437	2"	\$ 145.00	1	16
TPTB1438	3"	\$ 155.00	1	16

**Tornillo de banco giratorio uso pesado**



Etiqueta

CÓDIGO	DESC.	PRECIO	INNER	MASTER
TPTB3G	3"	\$ 777.00	1	2
TPTB4G	4"	\$ 1050.00	1	2
TPTB5G	5"	\$ 1,390.00	1	1
TPTB6G	6"	\$ 2,900.00	1	1

**Navaja para cepillo 2"**

Acero al cromo vanadio



Blister

CÓDIGO	PRECIO	INNER	MASTER
TPNC413	\$ 65.00	12	72

**Cepillo para carpintero profesional**

Zapata lisa



Base de hierro dúctil



Caja a color

CÓDIGO	DESC.	PRECIO	INNER	MASTER
TPCM411	No. 4	\$ 630.00	1	6
TPCM412	No. 5	\$ 720.00	1	6

**Prensa tipo C**

Tornillo con rosca tipo acme

Cuerpo de hierro



Mango deslizante tipo "T"

Virola giratoria



Caja a color

CÓDIGO	DESC.	PRECIO	INNER	MASTER
TPCC3HD	3"	\$ 82.00	6	36
TPCC4HD	4"	\$ 105.00	4	24
TPCC6HD	6"	\$ 185.00	6	18
TPCC8HD	8"	\$ 250.00	2	12

**Serrucho costilla profesional 14"**



Etiqueta

CÓDIGO	PRECIO	INNER	MASTER
TPSP599	\$ 140.00	12	48

**Serrucho profesional 18"**



Etiqueta

CÓDIGO	PRECIO	INNER	MASTER
TPSP597	\$ 120.00	6	48

**Serrucho profesional 24"**



Etiqueta

CÓDIGO	PRECIO	INNER	MASTER
TPSP598	\$ 150.00	12	24

**Serrucho para muros de yeso 6"**

Filo máxima duración

Hoja templada



Triple filo en los dientes

Acero SK5

Mango ergonómico



Tarjeta

CÓDIGO	PRECIO	INNER	MASTER
TPCR613	\$ 72.00	6	36

**Formón**

Longitud de la hoja: 10 cm

Más durable por su fabricación en acero cromo vanadio

Antiderrapante "comfort grip"



Mango ergonómico



Blister Doble

CÓDIGO	DESCRIPCIÓN	PRECIO	INNER	MASTER
TPFM14	1/4"	\$ 87.00	12	48
TPFM38	3/8"	\$ 87.00	12	48
TPFM12	1/2"	\$ 87.00	12	48
TPFM58	5/8"	\$ 87.00	12	48
TPFM34	3/4"	\$ 87.00	12	48
TPFM78	7/8"	\$ 87.00	12	48
TPFM1	1"	\$ 90.00	12	48
TPFM114	1 1/4"	\$ 105.00	12	48
TPFM112	1 1/2"	\$ 105.00	12	48

**Cinzel**

Cabeza grande para mejor impacto

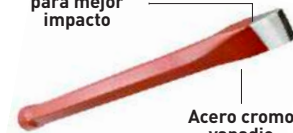

Acero cromo vanadio



Colgante con etiqueta

CÓDIGO	DESCRIPCIÓN	PRECIO	INNER	MASTER
TPC514	1/4" x 6"	\$ 28.00	6	36
TPC515	5/8" x 6"	\$ 46.00	6	36
TPC516	3/4" x 6"	\$ 52.00	6	36
TPC517	7/8" x 8"	\$ 66.00	6	36
TPC518	1" x 8"	\$ 85.00	6	36
TPC519	7/8" x 10"	\$ 72.00	6	36
TPC520	1" x 10"	\$ 99.00	6	36
TPC521	3/4" x 12"	\$ 80.00	6	36
TPC522	7/8" x 12"	\$ 104.00	6	36
TPC523	1" x 12"	\$ 123.00	6	36

El aspecto, empaque, inner o master de los productos puede variar sin previo aviso debido a la innovación continua de nuestras marcas.



## Ménsula de acero



De **36 kg a 62 kg** de carga (dependiendo del tamaño)



**6** Puntos de sujeción

Espesor de **1 mm a 1.2 mm**

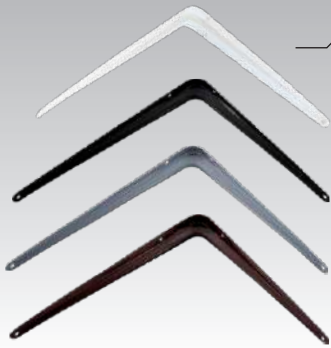

Etiqueta

## Ménsula de acero reforzada gancho 12" x 10"



Hasta **40 kg** de carga



**5** Puntos de sujeción

Espesor de **2.4 mm**



Etiqueta

## Ménsula de acero reforzada



Hasta **100 kg** de carga



**6** Puntos de sujeción

Espesor de **4 mm**



Etiqueta

	CÓDIGO	DESC.	PRECIO	INNER	MASTER
Café	TPSC45	4" x 5"	\$6.00	24	288
	TPSC56	5" x 6"	\$7.00	24	288
	TPSC68	6" x 8"	\$9.00	24	288
	TPSC810	8" x 10"	\$13.50	24	288
	TPSC1012	10" x 12"	\$18.00	24	144
Gris	TPSG45	4" x 5"	\$6.00	24	288
	TPSG56	5" x 6"	\$7.00	24	288
	TPSG68	6" x 8"	\$9.00	24	288
	TPSG810	8" x 10"	\$13.50	24	144
	TPSG1012	10" x 12"	\$18.00	24	144
Negra	TPSN45	4" x 5"	\$6.00	24	288
	TPSN56	5" x 6"	\$7.00	24	288
	TPSN68	6" x 8"	\$9.00	24	288
	TPSN810	8" x 10"	\$13.50	24	144
	TPSN1012	10" x 12"	\$18.00	24	144
Blanca	TPSB45	4" x 5"	\$6.00	24	288
	TPSB56	5" x 6"	\$7.00	24	288
	TPSB68	6" x 8"	\$9.00	24	288
	TPSB810	8" x 10"	\$13.50	24	144
	TPSB1012	10" x 12"	\$18.00	24	144
	TPSB1214	12" x 14"	\$22.00	25	120

	CÓDIGO	PRECIO	INNER	MASTER
Café	TPMR1923	\$ 53.00	1	20
Gris	TPMR1935	\$ 53.00	1	20
Negra	TPMR1929	\$ 53.00	1	20
Blanca	TPMR1917	\$ 53.00	1	20

	CÓDIGO	DESC.	PRECIO	INNER	MASTER
Café	TPMR1918	8" x 10"	\$53.00	1	10
	TPMR1919	8" x 12"	\$59.00	1	10
	TPMR1920	10" x 12"	\$66.00	1	10
	TPMR1921	10" x 16"	\$77.00	1	10
	TPMR1922	13" x 20"	\$98.00	1	10
Gris	TPMR1930	8" x 10"	\$53.00	1	10
	TPMR1931	8" x 12"	\$59.00	1	10
	TPMR1932	10" x 12"	\$66.00	1	10
	TPMR1933	10" x 16"	\$77.00	1	10
	TPMR1934	13" x 20"	\$98.00	1	10
Negra	TPMR1924	8" x 10"	\$53.00	1	10
	TPMR1925	8" x 12"	\$59.00	1	10
	TPMR1926	10" x 12"	\$66.00	1	10
	TPMR1927	10" x 16"	\$77.00	1	10
	TPMR1928	13" x 20"	\$98.00	1	10
Blanca	TPMR1912	8" x 10"	\$53.00	1	10
	TPMR1913	8" x 12"	\$59.00	1	10
	TPMR1914	10" x 12"	\$66.00	1	10
	TPMR1915	10" x 16"	\$77.00	1	10
	TPMR1916	13" x 20"	\$98.00	1	10

## Escuadra para repisa

Cuerpo de acero

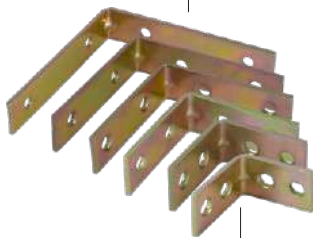

Escuadra de 90°



Caja a color

CÓDIGO	DESC.	PRECIO	CAJA	INNER	MASTER
TPSS25	25 x 25 mm	\$ 1.80	\$ 180.00	100	2000
TPSS30	30 x 30 mm	\$ 2.00	\$ 200.00	100	2000
TPSS40	40 x 40 mm	\$ 2.60	\$ 260.00	100	2000
TPSS50	50 x 50 mm	\$ 3.50	\$ 350.00	100	1000
TPSS60	60 x 60 mm	\$ 4.50	\$ 450.00	100	800
TPSS75	75 x 75 mm	\$ 6.00	\$ 600.00	100	600

## Gancho para perfocel



Gancho galvanizado



Caja a color

CÓDIGO	DESC.	PRECIO	INNER	MASTER
TPPH4	4"	\$ 8.00	100	400
TPPH6	6"	\$ 10.00	100	400
TPPH8	8"	\$ 11.00	100	400
TPPH10	10"	\$ 12.00	100	400

## Gancho para panel ranurado

Galvanizado



Caja a color

CÓDIGO	DESC.	PRECIO	INNER	MASTER
TPSH4	4"	\$ 11.00	100	400
TPSH6	6"	\$ 12.00	100	400
TPSH8	8"	\$ 15.00	100	400
TPSH10	10"	\$ 16.00	100	400

El aspecto, empaque, inner o master de los productos puede variar sin previo aviso debido a la innovación continua de nuestras marcas.



**Broca manita para madera**

Ideal para perforaciones de gran diámetro con todo tipo de madera y aglomerados



Reafilable

CÓDIGO	DESC.	PRECIO	INNER	MASTER
TPBMP14	1/4"	\$ 24.00	24	144
TPBMP516	5/16"	\$ 23.00	24	144
TPBMP38	3/8"	\$ 24.00	24	144
TPBMP716	7/16"	\$ 24.00	24	144
TPBMP12	1/2"	\$ 25.00	24	144
TPBMP916	9/16"	\$ 26.00	24	144
TPBMP58	5/8"	\$ 27.00	24	144
TPBMP34	3/4"	\$ 30.00	24	144
TPBMP78	7/8"	\$ 33.00	24	144
TPBMP1	1"	\$ 34.00	24	144
TPBMP118	1 1/8"	\$ 36.00	24	144
TPBMP114	1 1/4"	\$ 41.00	24	144
TPBMP112	1 1/2"	\$ 46.00	24	144

Blister Doble



**Broca para vidrio y azulejo**

Perfora: vidrio, mosaico, azulejo, lozas, porcelana y cerámica



Blister Doble

CÓDIGO	DESCRIPCIÓN	PRECIO	INNER	MASTER
TPBV316	3/16"	\$ 36.00	50	500
TPBV14	1/4"	\$ 39.00	50	500
TPBV516	5/16"	\$ 50.00	50	500
TPBV38	3/8"	\$ 53.00	50	500
TPBV12	1/2"	\$ 80.00	50	500

**Mandril para sierra sacabocados**



Blister Doble

CÓDIGO	DESCRIPCIÓN	PRECIO	INN.	MAS.
TPCHU916	9/16" a 1 3/16"	\$ 80.00	12	60
TPCHU114	1 1/4" a 2 3/4"	\$ 145.00	12	60

**Juego de brocas manita para madera 3/8" a 1"**

Ideal para perforaciones de gran diámetro con todo tipo de madera y aglomerados

Medidas: 3/8", 1/2", 5/8", 3/4", 7/8" y 1"



Blister Doble

CÓDIGO	PRECIO	INNER	MASTER
TPJBMP590	\$ 165.00	6	48

**Sierra corta círculos bimetálica**

Para corte de: lámina placa, polín, metales ferrosos y no ferrosos

Dientes de sierra con tamaño variable para un corte más veloz



Blister Doble

CÓDIGO	DESCRIPCIÓN	PRECIO	INNER	MASTER
TPBHS78	7/8"	\$ 65.00	12	72
TPBHS1	1"	\$ 67.00	12	72
TPBHS114	1 1/4"	\$ 86.00	12	72
TPBHS112	1 1/2"	\$ 95.00	12	72
TPBHS134	1 3/4"	\$ 110.00	12	72
TPBHS2	2"	\$ 120.00	12	72
TPBHS218	2 1/8"	\$ 130.00	12	72
TPBHS214	2 1/4"	\$ 140.00	12	72
TPBHS212	2 1/2"	\$ 150.00	12	72

**Sacabocado profesional para corte de metal 13 piezas**



Caja a color

CÓDIGO	PRECIO	INNER	MASTER
TPHS13BM	\$ 1,200.00	1	10

**Juego cortacírculos para cerradura 3 piezas**

1 Corta círculos 2 1/8"  
1 Broca paleta 7/8"  
1 Broca guía



Blister Doble

CÓDIGO	PRECIO	INNER	MASTER
TPLIK3	\$ 72.00	12	60

El aspecto, empaque, inner o master de los productos puede variar sin previo aviso debido a la innovación continua de nuestras marcas.



### Cortador de vidrio 5"

Diseño de dientes para remover bordes

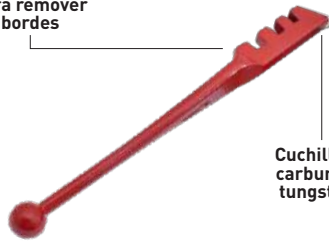

Cuchilla de carburo de tungsteno



Blister Doble

CÓDIGO	PRECIO	INNER	MASTER
TPCV591	\$ 51.00	12	240

### Raspador con navaja 1 1/2"

Para limpiar pegamentos, pintura, silicón y cemento de superficies lisas

Navaja de acero al alto carbono

Mango ergonómico



Blister Doble

CÓDIGO	PRECIO	INNER	MASTER
TPRN1145	\$ 47.00	12	72

### Mini raspador con navaja 1 1/2" (4 piezas)

Para limpiar pegamentos, pintura, silicón y cemento de superficies lisas

Navaja de acero al alto carbono



Blister Doble

CÓDIGO	PRECIO	INNER	MASTER
TPMR1134	\$ 33.00	12	72

### Repuesto navaja raspador 1 1/2" (5 Piezas)

Para limpiar pegamentos, pintura, silicón y cemento de superficies lisas

Navaja de acero al alto carbono



Blister Doble

CÓDIGO	PRECIO	INNER	MASTER
TPRN1135	\$ 22.00	12	72

### Navaja de un filo (100 piezas)



Caja a color

CÓDIGO	PIEZA	PAQUETE	INNER	MASTER
TPBLADE100	\$ 1.15	\$ 115.00	1	50

### Repuesto para navaja



Blister Doble

CÓDIGO	DESC.	PIEZA	PAQUETE	INN.	MAS.
TPUKQ10	10 Piezas	\$ 2.50	\$ 25.00	24	144
TPUKQ100	100 Piezas	\$ 1.65	\$ 165.00	25	50

### Navaja para hobby



Incluye 5 repuestos

Para cortes de precisión



Mango de caucho para mejor control



Blister Doble

CÓDIGO	PRECIO	INNER	MASTER
TPNH513	\$ 55.00	6	36

### Repuesto para navaja hobby (5 piezas)

0.5 mm de espesor



Blister Doble

CÓDIGO	PIEZA	PAQUETE	INNER	MASTER
TPRNH566	\$ 5.10	\$ 25.50	6	96

### Juego de cortadores de precisión 13 cuchillas

Fabricadas en acero SK5 2 veces más durable

Para corte de papel, plástico, madera, aluminio y acetatos

Para artes gráficas y manualidades

Práctico estuche magnetizado para sujetar las cuchillas



Blister Doble

CÓDIGO	PRECIO	INNER	MASTER
TPCP1457	\$ 90.00	6	48

### Repuesto navaja raspador 4" 5 piezas

Para cualquier tipo de raspado en vidrio o cerámica

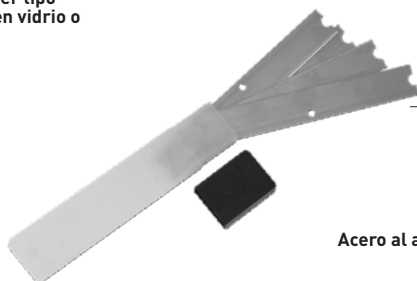

Acero al alto carbono



Blister Doble

CÓDIGO	PIEZA	PAQUETE	INNER	MASTER
TPRN1128	\$ 3.20	\$ 16.00	12	144

### Raspador con navaja 4"

Para limpiar pegamentos, pintura, silicón y cemento de superficies lisas

Cuerpo de acero

Mango ergonómico de TPR



Navaja de acero al alto carbono



Blister Doble

CÓDIGO	DESCRIPCIÓN	PRECIO	INNER	MASTER
TPRM1126	Mango 13"	\$ 93.00	6	48
TPRE1127	Mango ext. 15"	\$ 185.00	6	48

**Cutter multiusos retráctil**



Cuerpo de ABS



CÓDIGO	DESCRIPCIÓN	PRECIO	INNER	MASTER
TPSOK9	9 mm 5"	\$ 8.00	24	288

**Cutter multiusos retráctil**



Cuerpo de ABS



CÓDIGO	DESCRIPCIÓN	PRECIO	INNER	MASTER
TPSOK18	18 mm 6"	\$ 15.00	24	288

**Cutter retráctil 7"**



Cuerpo de ABS



CÓDIGO	PRECIO	INNER	MASTER
TPNR1458	\$ 31.00	12	72

**Cutter retráctil 5"**



Cuerpo de ABS



CÓDIGO	PRECIO	INNER	MASTER
TPNR1459	\$ 9.50	12	72

**Cutter retráctil 5" con repuesto**



Incluye 3 repuestos



Mango de goma para mejor sujeción



CÓDIGO	PRECIO	INNER	MASTER
TPNP509	\$ 40.00	12	144

**Cutter retráctil 7" con repuesto**



Incluye 3 repuestos



Seguro

Mango de goma para mejor sujeción



CÓDIGO	PRECIO	INNER	MASTER
TPNP508	\$ 40.00	6	72

**Cutter retráctil 7" con repuesto**

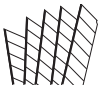

Incluye 5 repuestos



CÓDIGO	PRECIO	INNER	MASTER
TPNP510	\$ 130.00	6	72

**Repuesto navaja 10 piezas 7" 18 mm**



CÓDIGO	PIEZA	PAQUETE	INNER	MASTER
TPRN511	\$ 2.70	\$ 27.00	12	144

**Repuesto navaja 10 piezas 5" 9 mm**

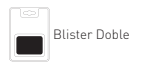

CÓDIGO	PIEZA	PAQUETE	INNER	MASTER
TPRN512	\$ 1.80	\$ 18.00	12	144

**Navaja plegadiza**



Incluye 5 repuestos



CÓDIGO	PRECIO	INNER	MASTER
TPUKF	\$ 98.00	12	72

**Navaja retráctil uso rudo**



Incluye 2 repuestos

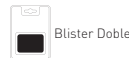

CÓDIGO	PRECIO	INNER	MASTER
TPUKQ3	\$ 125.00	6	72

**Navaja retráctil**

Para tablaroca



Incluye 2 repuestos



CÓDIGO	PRECIO	INNER	MASTER
TPUK2	\$ 45.00	12	72

El aspecto, empaque, inner o master de los productos puede variar sin previo aviso debido a la innovación continua de nuestras marcas.

### Arco para segueta tubular de alta tensión

Para corte en 90° y 45°



CÓDIGO	PRECIO	INNER	MASTER
TPAS1140	\$ 140.00	6	36

### Mini arco segueta 10"

Para cortes en espacios reducidos  
Incluye segueta 10"



CÓDIGO	PRECIO	INNER	MASTER
TPMA375	\$ 64.00	12	120

### Mini arco para calar con seguetas 6 1/2"



Incluye 5 repuestos



CÓDIGO	PRECIO	INNER	MASTER
TPCOP55	\$ 72.00	12	72

### Segueta bimetalica 100 piezas

Cuerpo flexible de acero  
Dientes de acero M2  
Sometidas a tratamiento térmico que proporciona su dureza y resistencia para cortes precisos  
Gran durabilidad



\*Precio por pieza en cartucho de 100 piezas



Contenedor plástico etiqueta

CÓDIGO	DESCRIPCIÓN	PRECIO	INN.	MAS.
TPSB800	18 Dientes P/pulg	\$ 14.00	100	1000
TPSB801	24 Dientes P/pulg	\$ 14.00	100	1000

### Arco para segueta de 12"

Tubular reforzado



Tarjeta

CÓDIGO	PRECIO	INNER	MASTER
TPASMR12	\$ 87.00	12	48

### Arco para segueta de 12"

Solera de 4.5 mm x 19 mm

Ajustable: 8", 10" y 12"



Etiqueta

CÓDIGO	PRECIO	INNER	MASTER
TPHFCE	\$ 75.00	6	36

### Arco para segueta de 12"

Reforzado



Tarjeta

CÓDIGO	PRECIO	INNER	MASTER
TPHFC2	\$ 80.00	12	48

### Arco para segueta de 12"



Tarjeta

CÓDIGO	PRECIO	INNER	MASTER
TPA355	\$ 190.00	6	24

### Cuchillas para cortazulejo



Blister

CÓDIGO	DESCRIPCIÓN	PRECIO	INNER	MASTER
TP183	15 x 6 x 1.5 mm	\$ 68.00	24	240
TP182	15 x 6 x 2 mm	\$ 92.00	24	240

### Cortadora azulejo eléctrica disco 7" UL

Para uso ligero (no industrial)  
120 V~ 4.8 A

Incluye disco cortador de azulejo 7"

Para corte fino sin despostillar



Caja a color

CÓDIGO	PRECIO	INNER
TPETC7	\$ 2,550.00	1

### Cortadora de azulejo 3 en 1



Caja a color

CÓDIGO	PRECIO	INNER	MASTER
TPTC16P	\$ 1050.00	1	4

### Cortadora de azulejo sencilla

Capacidad de corte 16"



Caja a color

CÓDIGO	PRECIO	INNER	MASTER
TPTC16S	\$ 725.00	1	4

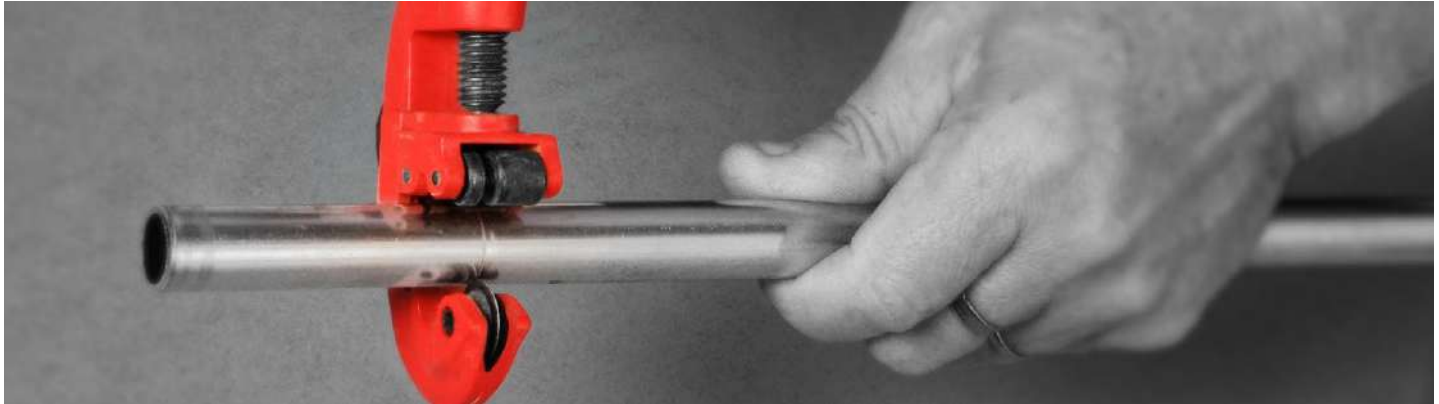

**Cepillo para tubería de cobre y conexiones 1/2" y 3/4"**



CÓDIGO	PRECIO	INNER	MASTER
TPPTC4	\$ 69.00	12	144

**Cortador de tubo de plástico de 1 5/8"**

Corta tubo de: PVC, CPVC, PP-R, PEX, POLY, PE, ABS etc.

Navaja de tratamiento térmico antidesgaste y antioxidante



CÓDIGO	PRECIO	INNER	MASTER
TPPCP158	\$ 150.00	6	24

**Separador de piso**

Para la instalación de: cerámica, porcelanato, piedra y mármol



CÓDIGO	DESCRIPCIÓN	PRECIO	INNER	MASTER
SEPP18	1/8" 120 pzas	\$ 32.00	1	300
SEPP316	3/16" 90 pzas	\$ 32.00	1	300
SEPP14	1/4" 80 pzas	\$ 32.00	1	300
SEPP516	5/16 80 pzas	\$ 32.00	1	300
SEPP38	3/8" 60 pzas	\$ 32.00	1	150
SEPP12	1/2" 50 pzas	\$ 32.00	1	100

**Cortatubo 1/8" x 1 1/4"**

Reforzado



Cuchilla de acero



CÓDIGO	PRECIO	INNER	MASTER
TPTUBC114Q	\$ 220.00	12	48

**Cortatubo #2 de 1/2" a 2"**



Cuchilla de acero



CÓDIGO	PRECIO	INNER	MASTER
TPPC2	\$ 650.00	1	10

**Juego de cortatubo con avellanador 6 piezas**

Contiene	
Floreador para tubos de:	3/16", 1/4", 5/16" 3/8" 1/2"
Dobladoras de tubos:	1/4" 5/16" 3/8"
Cortadora para tubos que corta:	1/8" hasta 1 1/8"

CÓDIGO	PRECIO
TPTBK7	\$ 400.00

**Cortatubo mini**



Cuchilla de acero



CÓDIGO	PRECIO	INNER	MASTER
TPMTC	\$ 90.00	12	72

**Cortatubo 1/8" x 1 1/8"**

Reforzado



Cuchilla de acero

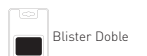

CÓDIGO	PRECIO	INNER	MASTER
TPTUBC118B	\$ 100.00	10	60



INNER	MASTER
1	10

**CARDAS**

**CARDAS**

**TIPO**

**CAMPOS DE APLICACIÓN**



-Cepillado mas basto (Alambre grueso).



-Acabado suave (Alambre fino).



-Especial para trabajos pesados.



-Limpia cordones de soldadura y uniones de tuberia.

-Aplicaciones ligeras.

-Proporciona cepillado continuo y fijo.

-Para uso en espacios reducidos.

-Superficies irregulares.

**Carda copa alambre ondulado 5/8" - 11**

Limpieza de superficies

Acero al carbono



Blister Doble

CÓDIGO	DESCRIPCIÓN	PRECIO	INN.	MAS.
TPC296	3" x 5/8 Cal. 30 mm	\$ 65.00	6	48
TPC297	4" x 5/8 Cal. 35 mm	\$ 100.00	6	24
TPC298	5" x 5/8 Cal. 35 mm	\$ 140.00	6	24

**Carda copa alambre 5/8" - 11 trenzado fino Cal. 35 mm**

Desbaste rápido

Acero al carbono



Blister Doble

CÓDIGO	DESC.	PRECIO	INNER	MASTER
TPC299	3" x 5/8"	\$ 85.00	6	24
TPC300	4" x 5/8"	\$ 135.00	6	24

**Carda copa alambre 5/8" - 11 trenzado grueso 5" Cal. 5 mm**

Desbaste rápido

Acero al carbono



Blister Doble

CÓDIGO	PRECIO	INNER	MASTER
TPC301	\$ 170.00	6	24

**Carda circular alambre ondulado Cal. 35 mm**

Limpieza de superficies

Acero al carbono



Blister Doble

CÓDIGO	DESC.	PRECIO	INNER	MASTER
TPC308	6" x 3/4"	\$ 132.00	6	24
TPC309	6" x 1 3/16"	\$ 142.00	6	24

**Carda de alambre para esmeril 6"**

Limpieza de superficies

Acero al carbono



Blister Doble

CÓDIGO	PRECIO	INNER	MASTER
TPWW612C	\$ 80.00	12	48

**Carda circular trenzada 6" x 5/8" Cal. 5 mm**

Limpieza de soldadora

Acero al carbono



Blister Doble

CÓDIGO	PRECIO	INNER	MASTER
TPC302	\$ 165.00	6	24

**Carda circular trenzada con tuerca 6" x 5/8" - 11 Cal. 5 mm**

Limpieza de soldadora

Acero al carbono



Blister Doble

CÓDIGO	PRECIO	INNER	MASTER
TPC303	\$ 165.00	6	24

**Carda fina circular con vástago 2" x 1/4" Cal. 15 mm**

Para pulir y remover pintura

Acero latonado



Blister Doble

CÓDIGO	PRECIO	INNER	MASTER
TPC304	\$ 27.00	12	48

**Carda gruesa circular con vástago 3" x 1/4" Cal. 30 mm**

Para pulir y remover pintura

Acero latonado



Blister Doble

CÓDIGO	PRECIO	INNER	MASTER
TPC305	\$ 36.00	12	48

**Carda fina copa con vástago 2" x 1/4" Cal. 15 mm**

Para pulir y remover pintura

Acero latonado



Blister Doble

CÓDIGO	PRECIO	INNER	MASTER
TPC306	\$ 38.00	12	48

**Carda gruesa copa con vástago 3" x 1/4" Cal. 30 mm**

Para pulir y remover pintura

Acero latonado



Blister Doble

CÓDIGO	PRECIO	INNER	MASTER
TPC307	\$ 45.00	12	48

**Cepillo de alambre largo 3 x 19 líneas con espátula**

Alambre de alta resistencia



CÓDIGO	PRECIO	INNER	MASTER
TPWBS319L	\$ 36.00	6	96

**Cepillo de alambre 10" mango largo**

Alambre de alta resistencia



Mango plástico



CÓDIGO	PRECIO	INNER	MASTER
TPWB10L	\$ 26.00	12	120

**Cepillo para lijar conexiones de cobre**

Alambre de alta resistencia



CÓDIGO	DESC.	PRECIO	INNER	MASTER
TPCLC12	1/2"	\$ 28.00	200	400
TPCLC34	3/4"	\$ 30.00	100	400
TPCLC1	1"	\$ 32.00	100	400

**Cepillo de alambre 4 x 15 líneas con espátula**

Alambre de alta resistencia

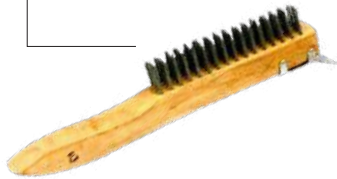

CÓDIGO	PRECIO	INNER	MASTER
TPWBS	\$ 33.00	12	72

**Cepillo de alambre 6 x 19 líneas**

Mango plástico



Alambre de alta resistencia



CÓDIGO	PRECIO	INNER	MASTER
TPWB619	\$ 58.00	12	96

**Cepillo de alambre 4 x 16 líneas**

Alambre de alta resistencia



Mango plástico



CÓDIGO	PRECIO	INNER	MASTER
TPCA461	\$ 34.00	6	96

**Cepillo de alambre 3 x 17 líneas con espátula**

Alambre de alta resistencia



Mango plástico



CÓDIGO	PRECIO	INNER	MASTER
TPCA462	\$ 34.00	12	96

**Juego de minicepillos de alambre 3 piezas**



Mango ergonómico

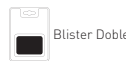

CÓDIGO	PRECIO	INNER	MASTER
TPJC1146	\$ 26.00	12	72

**Juego de minicepillos de alambre doble cara 3 piezas**

Alambre de alta resistencia



Antiderrapante

Mango ergonómico



CÓDIGO	PRECIO	INNER	MASTER
TPJC1147	\$ 50.00	12	120

**Cepillo de alambre 67 pinceles**

Largo: 25.5 cm  
Ancho: 3.2 cm  
Cerde: 2.7 cm



Mango de TPR



Alambre de acero al carbono de alta resistencia calibre 0.35 mm

CÓDIGO	PRECIO	INNER	MASTER
TPCA1117	\$ 55.00	6	36

**Cepillo de alambre triangulo 7"**

Doble agarre para mayor fuerza al trabajar



CÓDIGO	PRECIO	INNER	MASTER
TPCT1105	\$ 124.00	6	36

**Cepillo de alambre doble mango 156 pinceles**

2 Mangos para mayor fuerza al trabajar



Alambre de acero al carbono de alta resistencia calibre 0.30 mm

CÓDIGO	PRECIO	INNER	MASTER
TPCA1092	\$ 70.00	6	36

El aspecto, empaque, inner o master de los productos puede variar sin previo aviso debido a la innovación continua de nuestras marcas.

## Aceitera 180 ml

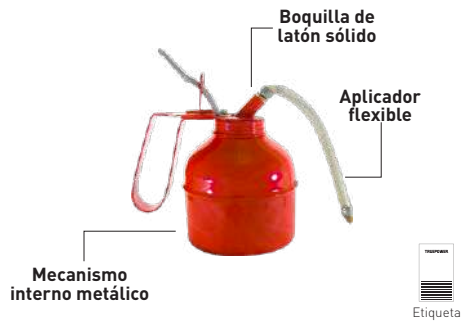

CÓDIGO	PRECIO	INNER	MASTER
TPA502	\$ 72.00	10	60

## Aceitera 300 ml

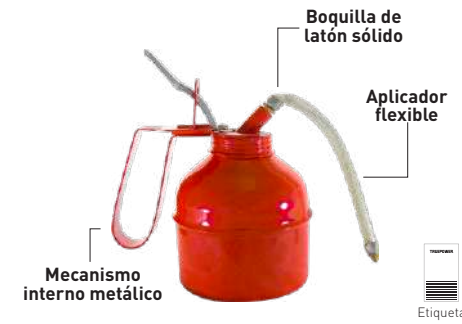

CÓDIGO	PRECIO	INNER	MASTER
TPA503	\$ 82.00	10	60

## Aceitera 500 ml

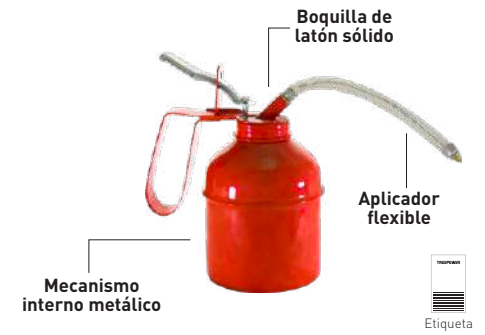

CÓDIGO	PRECIO	INNER	MASTER
TPA504	\$ 100.00	10	60

## Bomba extractora manual de líquidos

Cuerpo de hierro

Tubo de acero

- Ideal para:
- Aceite
  - Queroseno
  - Diesel
  - Petróleo

No utilice con agua ni corrosivos



CÓDIGO	PRECIO	INNER	MASTER
TPROP	\$ 550.00	1	6

## Bomba extractora de líquidos



CÓDIGO	PRECIO	INNER	MASTER
TPLBP	\$ 530.00	1	10

## Destapador de caños cable 7.5 m (25 ft)



CÓDIGO	PRECIO	INNER	MASTER
TPDSC25P	\$ 210.00	2	8

## Inyector de grasa manual

Incluye manguera flexible 12"



CÓDIGO	PRECIO	INNER	MASTER
TPHGG	\$ 360.00	1	10



## Boquilla para inyector de grasa

Para graseras convencional

Fabricado en acero

Con válvula check



CÓDIGO	PRECIO	INNER	MASTER
TPBI1141	\$ 41.00	36	360



## Manguera flexible 12" para inyector de grasa

Conexiones de 1/8" NPT  
Presión máxima 4500 psi



CÓDIGO	PRECIO	INNER	MASTER
TPMF1142	\$ 65.00	50	100



## Juego de empaque O-Ring 225 piezas



CÓDIGO	PRECIO	INNER	MASTER
TPORING225	\$ 150.00	1	32



## Juego de empaque O-Ring 407 piezas contenedor plástico



CÓDIGO	PRECIO	INNER	MASTER
TPORING407	\$ 315.00	1	24



El aspecto, empaque, inner o master de los productos puede variar sin previo aviso debido a la innovación continua de nuestras marcas.



Lima	Tipo	Superficies
	Escofina bastarda (Madera)	Para curvas y esquinas
	Bastarda (Metal)	
	Bastarda (Metal)	Zonas angostas y orificios
	Cadena motosierra	
	Pesado	Limpieza de soldadura
	Triángulo 2 puntas (Metal)	
	Muza (Hierro y acero)	Áreas planas y esquinas
	Bastarda (Hierro y acero)	

### Lima cadena motosierra

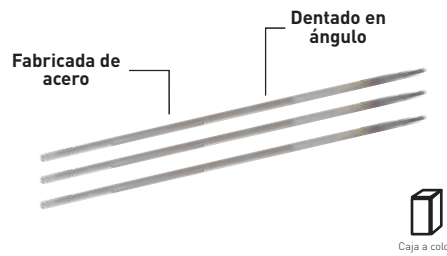

CÓDIGO	LARGO	ANCHO	ESPESOR	PRECIO	INN.	MAS.
TPLC544	8"	5/32"	4.0 mm	\$ 32.00	12	600
TPLC545	8"	3/16"	4.8 mm	\$ 32.00	12	600
TPLC546	8"	7/32"	5.5 mm	\$ 32.00	12	600

### Lima plana bastarda

Para trabajos sobre hierro y acero

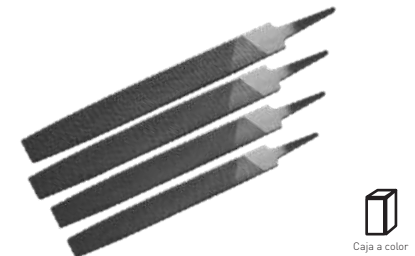

CÓDIGO	LARGO	ANCHO	ESPESOR	PRECIO	INN.	MAS.
TPLPB524	6"	5/8"	3/16"	\$ 32.00	12	300
TPLPB525	8"	3/4"	1/4"	\$ 45.00	12	300
TPLPB526	10"	1"	5/16"	\$ 62.00	12	300
TPLPB527	12"	1 3/16"	5/16"	\$ 95.00	6	60

### Lima plana muza

Corte doble

Para acabado fino

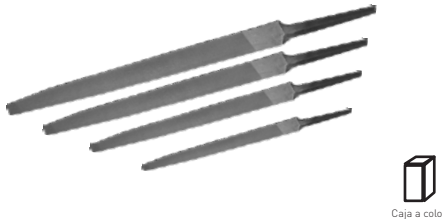

CÓDIGO	LARGO	ANCHO	ESPESOR	PRECIO	INN.	MAS.
TPLPM528	6"	5/8"	3/16"	\$ 36.00	12	300
TPLPM529	8"	3/4"	1/4"	\$ 55.00	12	192
TPLPM530	10"	1"	5/16"	\$ 75.00	12	120
TPLPM531	12"	1 3/16"	5/16"	\$ 110.00	6	60

### Lima escofina media caña bastarda

Anchura y espesor ahusados

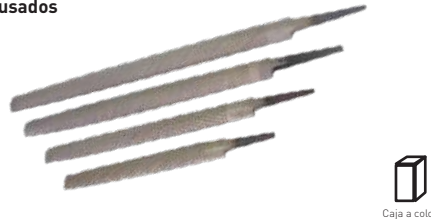

CÓDIGO	LARGO	ANCHO	ESPESOR	PRECIO	INN.	MAS.
TPLE532	6"	5/8"	3/16"	\$ 55.00	12	300
TPLE533	8"	1 3/16"	1/4"	\$ 70.00	12	180
TPLE534	10"	1 5/16"	3/8"	\$ 85.00	12	96
TPLE535	12"	1 3/16"	7/16"	\$ 120.00	12	72

### Lima media caña bastarda

Anchura y espesor ahusados



CÓDIGO	LARGO	ANCHO	ESPESOR	PRECIO	INN.	MAS.
TPLM536	6"	5/8"	3/16"	\$ 48.00	12	288
TPLM537	8"	3/4"	1/4"	\$ 60.00	12	192
TPLM538	10"	1"	5/16"	\$ 82.00	12	96
TPLM539	12"	1 3/16"	3/8"	\$ 115.00	6	60

### Lima redonda bastarda



CÓDIGO	LARGO	DIÁMETRO	PRECIO	INN.	MAS.
TPLR540	6"	1/4"	\$ 28.00	12	480
TPLR541	8"	5/16"	\$ 36.00	12	300
TPLR542	10"	3/8"	\$ 52.00	12	144
TPLR543	12"	1/2"	\$ 80.00	6	72

### Lima triángulo 2 puntas

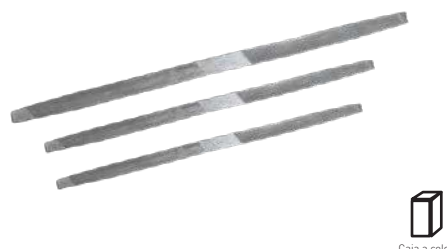

CÓDIGO	LARGO	ANCHO	PRECIO	INN.	MAS.
TPLT550	6"	3/16"	\$ 27.50	12	720
TPLT551	7"	7/32"	\$ 32.00	12	600
TPLT552	8"	1/4"	\$ 35.00	12	300

### Lima triángulo pesado



CÓDIGO	LARGO	ANCHO	PRECIO	INN.	MAS.
TPLT547	6"	9/16"	\$ 23.00	12	240
TPLT548	7"	5/8"	\$ 32.00	12	192
TPLT549	8"	1 1/16"	\$ 43.00	12	144

El aspecto, empaque, inner o master de los productos puede variar sin previo aviso debido a la innovación continua de nuestras marcas.



### Piedra para esmeril 6"

3,450 RPM  
3/4" Espesor  
1/2" Barreno



Etiqueta

CÓDIGO	PRECIO	INNER	MASTER
TPGSW6	\$ 67.00	1	24

### Piedra para afilar abrasiva 9"

Ideal para afilar:  
cuchillos, hachas,  
herramientas  
pequeñas

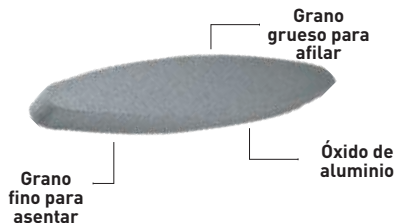

Caja a color

CÓDIGO	PRECIO	INNER	MASTER
TPSTONE9A	\$ 24.00	1	100

### Esmeril de banco 6" 3/4 HP

127 V~  
60 Hz  
560 W  
5 A



Caja a color

CÓDIGO	PRECIO	INNER
TPBG6	\$ 1,500.00	1

### Juego de piedras abrasivas



Blister

CÓDIGO	DESC.	PRECIO	INNER	MASTER
TPMMS5	5 Piezas	\$ 56.00	12	120
TPMMS10	10 Piezas	\$ 80.00	12	120

### Piedra para afilar abrasiva

Ideal para afilar:  
cuchillos, hachas,  
herramientas  
pequeñas

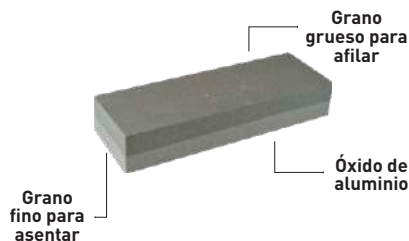

Caja a color

CÓDIGO	DESC.	PRECIO	INNER	MASTER
TPSTONE6	6"	\$ 20.00	1	48
TPSTONE8	8"	\$ 24.00	1	48

### Lija esmeril 9" x 11" papel flexible óxido de aluminio



Caja a color

CÓDIGO	DESCRIPCIÓN	PRECIO	INN.	MAS.
TPLE928	# 80	\$ 10.00	25	250
TPLE929	# 100	\$ 9.50	25	250
TPLE930	# 120	\$ 9.50	25	250

### Lija de agua 9" x 11" papel impermeable carburo de silicio



Caja a color

CÓDIGO	DESCRIPCIÓN	PRECIO	INN.	MAS.
TPLA925	# 80	\$ 9.00	25	250
TPLA924	# 100	\$ 8.00	25	250
TPLA923	# 120	\$ 8.00	25	250
TPLA922	# 150	\$ 7.00	25	250
TPLA921	# 180	\$ 7.50	25	250
TPLA920	# 220	\$ 7.50	25	250
TPLA919	# 240	\$ 7.00	25	250
TPLA918	# 320	\$ 7.00	25	250
TPLA917	# 360	\$ 7.00	25	250
TPLA916	# 400	\$ 7.50	25	250
TPLA915	# 500	\$ 7.50	25	250
TPLA914	# 600	\$ 7.50	25	250
TPLA913	# 1000	\$ 9.00	25	250
TPLA912	# 1200	\$ 10.00	25	250
TPLA911	# 1500	\$ 10.00	25	250
TPLA910	# 2000	\$ 10.00	25	250

### Lija esmeril 9" x 11" papel flexible óxido de aluminio



Caja a color

CÓDIGO	DESCRIPCIÓN	PRECIO	INN.	MAS.
TPLM1291	# 36	\$ 12.00	25	250
TPLE935	# 60	\$ 12.00	25	250
TPLE934	# 80	\$ 12.00	25	250
TPLE933	# 100	\$ 12.00	25	250
TPLE932	# 120	\$ 12.00	25	250
TPLE931	# 150	\$ 13.00	25	250
TPLE1292	# 180	\$ 12.00	25	250
TPLE1293	# 220	\$ 13.00	25	250
TPLE1294	# 320	\$ 13.00	25	250

### Lija para madera papel kraft óxido de aluminio



Caja a color

CÓDIGO	DESCRIPCIÓN	PRECIO	INN.	MAS.
TPLM936	# 36	\$ 7.00	25	250
TPLM1290	# 60	\$ 7.00	25	250
TPLM937	# 80	\$ 7.00	25	250
TPLM938	# 100	\$ 5.00	25	250
TPLM939	# 120	\$ 5.00	25	250
TPLM940	# 150	\$ 5.00	25	250
TPLM941	# 180	\$ 5.00	25	250
TPLM942	# 220	\$ 5.50	25	250
TPLM943	# 320	\$ 5.50	25	250



**DISCOS  
DE SIERRA**

**Disco de sierra para madera 4 3/8"**

**40 Dientes**

Centro de 5/8"

Dientes de carburo de tungsteno



CÓDIGO	PRECIO	INNER	MASTER
TPSBC41240	\$ 50.00	20	200

**Disco de sierra para madera 7 1/4"**

Centro de 5/8"

Dientes de carburo de tungsteno



CÓDIGO	DESC.	PRECIO	INN.	MAS.
TPSBC71416	16 Dientes	\$ 125.00	18	36
TPSBC71420	20 Dientes	\$ 150.00	18	36
TPSBC71424	24 Dientes	\$ 160.00	18	36
TPSBC71430	30 Dientes	\$ 165.00	18	36
TPSBC71440	40 Dientes	\$ 190.00	18	36
TPSBC71460	60 Dientes	\$ 200.00	18	36

**Disco de sierra para madera 8 1/4"**

Centro de 5/8"

Dientes de carburo de tungsteno



CÓDIGO	DESC.	PRECIO	INNER	MASTER
TPSBC81424	24 Dientes	\$ 200.00	15	30
TPSBC81432	32 Dientes	\$ 215.00	15	30
TPSBC81440	40 Dientes	\$ 230.00	15	30

**Disco de sierra para madera 10"**

Centro de 1" con reductor a 5/8"

Dientes de carburo de tungsteno



CÓDIGO	DESC.	PRECIO	INNER	MASTER
TPSBC1040	40 Dientes	\$ 285.00	6	24
TPSBC1060	60 Dientes	\$ 340.00	6	24
TPSBC1080	80 Dientes	\$ 400.00	6	24

**Disco de sierra para madera 12"**

Centro de 5/8"

Dientes de carburo de tungsteno



CÓDIGO	DESC.	PRECIO	INNER	MASTER
TPSBC1240	40 Dientes	\$ 480.00	5	20
TPSBC1260	60 Dientes	\$ 540.00	5	20
TPSBC1280	80 Dientes	\$ 625.00	5	20

**Disco de sierra para aluminio 10"**

Centro de 5/8"

Dientes de carburo de tungsteno

Corte de PVC y laminados



CÓDIGO	DESC.	PRECIO	INN.	MAS.
TPSBCA1080	80 Dientes	\$ 400.00	6	24
TPSBCA10100	100 Dientes	\$ 520.00	6	24

**Disco de sierra para aluminio 12"**

Centro de 5/8"

Dientes de carburo de tungsteno

Corte de PVC y laminados



CÓDIGO	DESC.	PRECIO	INN.	MAS.
TPSBCA1280	80 Dientes	\$ 650.00	5	20
TPSBCA12100	100 Dientes	\$ 690.00	5	20

El aspecto, empaque, inner o master de los productos puede variar sin previo aviso debido a la innovación continua de nuestras marcas.

## Disco diamante rin continuo

Centro de 7/8" con reductor a 5/8"

CÓDIGO	Espesor profundidad
TPW4DW	1.9 mm x 7 mm
TPW412DW	1.9 mm x 7 mm
TPW7DW	2.4 mm x 7 mm
TPW9DW	2.6 mm x 7 mm



## Disco diamante turbo

Centro de 7/8" con reductor a 5/8"

CÓDIGO	Espesor profundidad
TPW4DT	2.1 mm x 7 mm
TPW412DT	2.1 mm x 7 mm
TPW7DT	2.5 mm x 7 mm
TPW9DT	2.5 mm x 7 mm



## Disco diamante rin segmentado

Centro de 7/8" con reductor a 5/8"

CÓDIGO	Espesor profundidad
TPW4DD	1.8 mm x 7 mm
TPW412DD	1.8 mm x 7 mm
TPW7DD	2.3 mm x 7 mm
TPW9DD	2.5 mm x 7 mm



CÓDIGO	DESC.	PRECIO	INNER	MASTER
TPW4DW	4"	\$ 55.00	12	144
TPW412DW	4 1/2"	\$ 56.00	12	144
TPW7DW	7"	\$ 120.00	12	48
TPW9DW	9"	\$ 240.00	6	36

CÓDIGO	DESC.	PRECIO	INNER	MASTER
TPW4DT	4"	\$ 55.00	12	144
TPW412DT	4 1/2"	\$ 56.00	12	144
TPW7DT	7"	\$ 120.00	12	48
TPW9DT	9"	\$ 240.00	6	36

CÓDIGO	DESC.	PRECIO	INNER	MASTER
TPW4DD	4"	\$ 55.00	12	144
TPW412DD	4 1/2"	\$ 56.00	12	144
TPW7DD	7"	\$ 120.00	12	48
TPW9DD	9"	\$ 240.00	6	36

## Disco de corte para metal

Disco óxido de aluminio



CÓDIGO	DESCRIPCIÓN	PRECIO	INN.	MAS.
TPCOW4	4" x 1/4" x 5/8"	\$ 16.00	50	400
TPCOW412	4 1/2" x 1/8" x 7/8"	\$ 19.00	50	400
TPCOW778	7" x 1/8 x 7/8"	\$ 50.00	50	100
TPCOW758	7" x 1/8" x 5/8"	\$ 55.00	50	100
TPCOW14	14" x 1/8" x 1"	\$ 100.00	1	25

## Disco de desbaste con adaptador

Cuerpo óxido de aluminio



CÓDIGO	PRECIO	INNER	MASTER
TPDGW7H	\$ 70.00	6	24

## Disco de corte para metal

Cuerpo óxido de aluminio



CÓDIGO	DESCRIPCIÓN	PRECIO	INN.	MAS.
TPCOW416	4" x 1/16" x 5/8"	\$ 13.00	50	400
TPCOW41216	4 1/2" x 1/16" x 7/8"	\$ 14.00	100	600

## Disco de desbaste para metal

Para acero inoxidable



CÓDIGO	DESCRIPCIÓN	PRECIO	INN.	MAS.
TPDGW4	4" x 1/4" x 5/8"	\$ 23.00	5	200
TPDGW412	4 1/2" x 1/4" x 7/8"	\$ 30.00	25	100

## Disco de corte para concreto

Cuerpo óxido de aluminio



CÓDIGO	DESCRIPCIÓN	PRECIO	INN.	MAS.
TPCOW778M	7" x 1/8" x 7/8"	\$ 50.00	5	200
TPCOW758M	7" x 1/8" x 5/8"	\$ 59.00	25	100

## Disco de corte para acero inoxidable

Cuerpo óxido de aluminio



Corrugado



CÓDIGO	DESCRIPCIÓN	PRECIO	INN.	MAS.
TP186	4 1/2" x 0.04" x 7/8"	\$ 16.00	50	600
TP187	7" x 5/64" x 7/8"	\$ 40.00	50	200

## Disco laminado 4" x 5/8"



CÓDIGO	DESCRIPCIÓN	PRECIO	INN.	MAS.
TP1070	Grano 40	\$ 55.00	1	200
TP1071	Grano 60	\$ 55.00	1	200
TP1072	Grano 80	\$ 55.00	1	200
TP1073	Grano 120	\$ 55.00	1	200

## Disco laminado 4 1/2" x 7/8"



CÓDIGO	DESCRIPCIÓN	PRECIO	INN.	MAS.
TP1074	Grano 40	\$ 65.00	1	200
TP1075	Grano 60	\$ 60.00	1	200
TP1076	Grano 80	\$ 60.00	1	200
TP1077	Grano 120	\$ 60.00	1	200

## Disco laminado 7" x 7/8"



CÓDIGO	DESCRIPCIÓN	PRECIO	INN.	MAS.
TP1078	Grano 40	\$ 145.00	1	80
TP1079	Grano 60	\$ 135.00	1	80
TP1080	Grano 80	\$ 135.00	1	80
TP1081	Grano 120	\$ 135.00	1	80

**Cadena de paseo para perro**



CÓDIGO	DESC.	PRECIO	INNER	MASTER
TPDC248	2 mm	\$ 19.00	12	120
TPDC2548	2.5 mm	\$ 21.00	12	120
TPDC348	3 mm	\$ 27.00	12	144
TPDC3548	3.5 mm	\$ 35.00	12	120
TPDC448	4 mm	\$ 40.00	6	60
TPDC548	5 mm	\$ 55.00	5	60

**Cadena de castigo para perro**

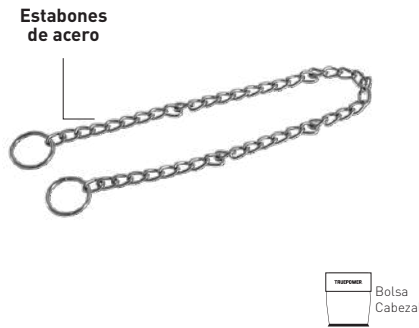

CÓDIGO	DESCRIPCIÓN	PRECIO	INN.	MAS.
TPDC216	2 mm (40.6 cm)	\$ 10.00	40	480
TPDC2545	2.5 mm (45 cm)	\$ 12.00	12	96
TPDC320	3 mm (50.8 cm)	\$ 14.00	12	192
TPDC3555	3.5 mm (55 cm)	\$ 18.00	12	96
TPDC460	4 mm (60 cm)	\$ 22.00	12	96
TPDC426	4 mm (66 cm)	\$ 25.50	30	120

**Nudo para cable galvanizado**



CÓDIGO	DESCRIPCIÓN	PRECIO	INN.	MAS.
TP265	1/8" Set 2 piezas	\$ 12.00	12	72
TP266	3/16" Set 2 piezas	\$ 11.00	12	72
TP267	1/4" Set 2 piezas	\$ 15.00	12	72
TP268	5/16" Set 2 piezas	\$ 20.00	12	72
TP269	3/8"	\$ 15.50	12	72
TP270	7/16"	\$ 18.00	12	72
TP271	1/2"	\$ 21.00	12	72
TP272	5/8"	\$ 31.00	12	72
TP273	3/4"	\$ 47.00	12	72
TP274	7/8"	\$ 60.00	12	72
TP275	1"	\$ 70.00	12	72

**Cadena tipo victor**

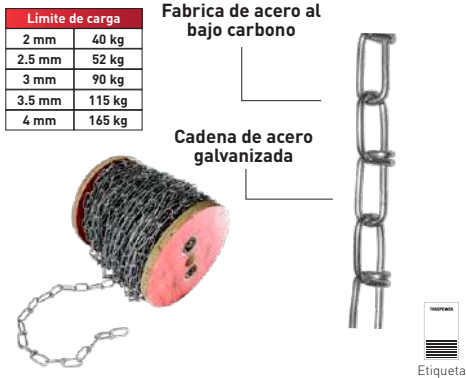

CÓDIGO	DESCRIPCIÓN	PRECIO	INN.	MAS.
TPCV967	2 mm x 30 m	\$ 290.00	1	4
TPCV968	2.5 mm x 30 m	\$ 335.00	1	4
TPCV969	3 mm x 30 m	\$ 450.00	1	4
TPCV970	3.5 mm x 30 m	\$ 570.00	1	4
TPCV971	4 mm x 15 m	\$ 409.00	1	4

**Cadena galvanizada en cubeta**



CÓDIGO	DESCRIPCIÓN	PRECIO LISTA	PRECIO METRO LINEAL	INNER	MASTER
TPCP961	1/8" x 75 m	\$ 2,000.00	\$ 26.67	1	2
TPCP962	3/16" x 65 m	\$ 2,200.00	\$ 33.84	1	2
TPCP963	1/4" x 35 m	\$ 2,200.00	\$ 62.85	1	2
TPCP964	5/16" x 20 m	\$ 1,920.00	\$ 96.00	1	2
TPCP965	3/8" x 10 m	\$ 1,350.00	\$ 135.00	1	2
TPCP966	1/2" x 5 m	\$ 1,200.00	\$ 240.00	1	2

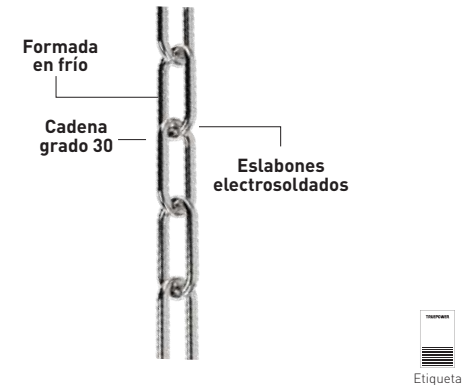

**Cadena plástica 5 mm Rollo con 25 m**

Límite de carga: 26 kg



CÓDIGO	DESC.	PRECIO	INNER	MASTER
TPCP956	Verde	\$ 390.00	1	8
TPCP957	Amarilla	\$ 390.00	1	8
TPCP958	Roja	\$ 390.00	1	8
TPCP959	Azul	\$ 390.00	1	8
TPCP960	Naranja	\$ 390.00	1	8

**Polipasto manual**



CÓDIGO	DESCRIPCIÓN	PRECIO	INN.	MAS.
TPCH1C	1 Tonelada	\$ 1,535.00	1	1
TPCH112	1 1/2 Toneladas	\$ 3,000.00	1	1
TPCH2	2 Toneladas	\$ 2,400.00	1	1
TPCH3	3 Toneladas	\$ 3,500.00	1	1

**Garrucha para noria**

Uso ligero



CÓDIGO	DESC.	PRECIO	INNER	MASTER
TP261	3/4"	\$ 25.00	12	72
TP262	1"	\$ 36.00	12	72
TP263	1 1/2"	\$ 55.00	12	72
TP264	2"	\$ 90.00	12	72

El aspecto, empaque, inner o master de los productos puede variar sin previo aviso debido a la innovación continua de nuestras marcas.

### Bandola de uña 4" con destorcedor

Uso ligero

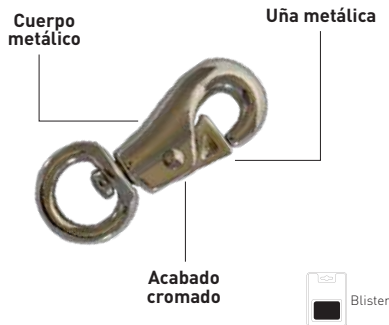

CÓDIGO	PRECIO	INNER	MASTER
TP213	\$ 66.00	12	72

### Bandola con destorcedor

Uso ligero

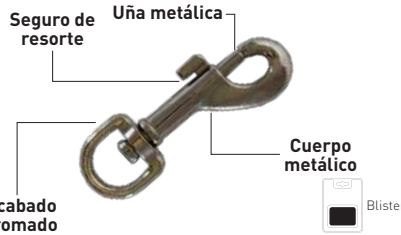

CÓDIGO	DESC.	PRECIO	INNER	MASTER
TP215	2"	\$ 15.00	12	72
TP216	3"	\$ 20.00	12	72
TP217	3 1/2"	\$ 22.00	12	72
TP218	4"	\$ 28.00	12	72
TP219	4 1/4"	\$ 44.00	12	72
TP214	4 1/2"	\$ 52.00	12	72

### Bandola con destorcedor

Cuerpo de latón  
Uso ligero



CÓDIGO	DESC.	PRECIO	INNER	MASTER
TP220	3 1/4"	\$ 60.00	12	72
TP221	3 3/8"	\$ 62.00	12	72
TP222	3 1/2"	\$ 76.00	12	72
TP223	4 1/2"	\$ 120.00	12	72
TP224	4 7/8"	\$ 136.00	12	72

### Bandola doble

Uso ligero



CÓDIGO	DESC.	PRECIO	INNER	MASTER
TP225	3 1/2"	\$ 25.00	12	72
TP226	4"	\$ 32.00	12	72
TP276	4 3/4"	\$ 44.00	12	72

### Bandola doble

Cuerpo de latón  
Uso ligero

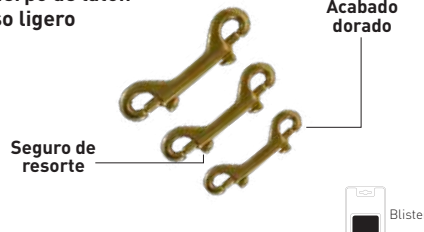

CÓDIGO	DESC.	PRECIO	INNER	MASTER
TP227	3 1/2"	\$ 65.00	12	72
TP228	4"	\$ 83.00	12	72
TP229	4 3/4"	\$ 95.00	12	72

### Bandola mosquetón con seguro

Uso ligero



CÓDIGO	DESCRIPCIÓN	PRECIO	INNER	MASTER
TP236	3/16" Set 2 pzas	\$ 16.00	12	72
TP237	1/4" Set 2 pzas	\$ 18.50	12	72
TP238	5/16"	\$ 16.00	12	72
TP239	3/8"	\$ 23.00	12	72
TP240	1/2"	\$ 38.00	12	72

### Destorcedor de cadena

Giro de cadena sin enredos



CÓDIGO	DESCRIPCIÓN	PRECIO	INNER	MASTER
TP241	1/8"	\$ 13.00	12	72
TP242	5/32"	\$ 22.00	12	72
TP243	3/16"	\$ 25.00	12	72
TP244	1/4"	\$ 25.00	12	72
TP245	5/16"	\$ 30.00	12	72

### Bandola de aluminio con seguro

Cuerpo de aluminio



CÓDIGO	DESCRIPCIÓN	PRECIO	INNER	MASTER
TP246	5 mm Set 2 pzas	\$ 17.00	12	72
TP247	6 mm Set 2 pzas	\$ 22.00	12	72
TP248	7 mm	\$ 17.00	12	72
TP249	8 mm	\$ 20.00	12	72

### Bandola con seguro

Uso moderado



CÓDIGO	DESCRIPCIÓN	PRECIO	INNER	MASTER
TP230	1/8" Set 2 pzas	\$ 17.00	12	72
TP231	3/16" Set 2 pzas	\$ 24.00	12	72
TP232	1/4" Set 2 pzas	\$ 26.00	12	72
TP233	5/16"	\$ 20.00	12	72
TP234	3/8"	\$ 28.00	12	72
TP235	1/2"	\$ 46.00	12	72

### Tensor de gancho y argolla

Uso ligero



CÓDIGO	DESCRIPCIÓN	PRECIO	INNER	MASTER
TP250	3/16" 90 lbs	\$ 18.00	12	72
TP251	1/4" 110 lbs	\$ 26.50	12	72
TP252	5/16" 220 lbs	\$ 36.50	12	72
TP253	3/8" 450 lbs	\$ 49.00	12	72

### Tensor de gancho y gancho

Uso ligero

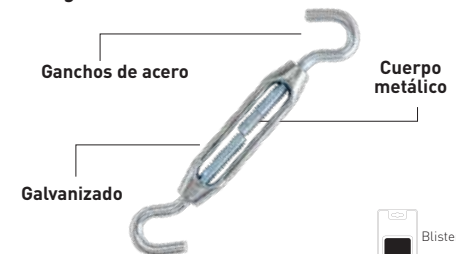

CÓDIGO	DESCRIPCIÓN	PRECIO	INNER	MASTER
TP254	3/16" 90 lbs	\$ 18.00	12	72
TP255	1/4" 110 lbs	\$ 26.00	12	72
TP256	5/16" 220 lbs	\$ 36.00	12	72
TP257	3/8" 450 lbs	\$ 45.00	12	72

### Gancho "S"

Uso ligero



CÓDIGO	DESCRIPCIÓN	PRECIO	INNER	MASTER
TP258	3/16" Set 2 pzas	\$ 12.00	12	72
TP259	1/4" Set 2 pzas	\$ 15.00	12	72
TP260	5/16"	\$ 14.00	12	72

# EQUIPO DE SEGURIDAD



## Chaleco de seguridad reforzado naranja

Poliéster 100% respirable  
Resistente al sol  
Cintas reflejantes plateadas 2"  
Cierra con broches  
Uso día y noche:  
Vista día 40 m  
Vista noche 150 m



Peso: 300 gr  
Unitalla  
7 bolsas



CÓDIGO	PRECIO	INNER	MASTER
TPCH1205	\$ 290.00	10	100

## Chaleco de seguridad con cierre naranja

Poliéster 100% respirable  
Resistente al sol  
Cintas reflejantes dobles 2"  
Uso día y noche:  
Vista día 40 m  
Vista noche 150 m



Peso: 220 gr  
Unitalla  
6 bolsas



CÓDIGO	PRECIO	INNER	MASTER
TPCH1207	\$ 200.00	10	100

## Chaleco de seguridad con cierre naranja

Poliéster 100% respirable  
Resistente al sol  
Cintas reflejantes dobles 3/4"  
Uso día y noche:  
Vista día 40 m  
Vista noche 150 m



Peso: 118 gr  
Unitalla



CÓDIGO	PRECIO	INNER	MASTER
TPCH1209	\$ 82.00	10	100

## Chaleco de seguridad con velcro naranja

Poliéster 100% respirable  
Resistente al sol  
Cintas reflejantes plateadas 2"  
Uso día y noche:  
Vista día 40 m  
Vista noche 150 m



Peso: 118 gr  
Unitalla



CÓDIGO	PRECIO	INNER	MASTER
TPCH1211	\$ 75.00	10	100

## Chaleco de seguridad reforzado amarillo

Poliéster 100% respirable  
Resistente al sol  
Cintas reflejantes plateadas 2"  
Cierra con broches  
Uso día y noche:  
Vista día 40 m  
Vista noche 150 m



Peso: 300 gr  
Unitalla  
7 bolsas



CÓDIGO	PRECIO	INNER	MASTER
TPCH1206	\$ 290.00	10	100

## Chaleco de seguridad con cierre amarillo

Poliéster 100% respirable  
Resistente al sol  
Cintas reflejantes dobles 2"  
Uso día y noche:  
Vista día 40 m  
Vista noche 150 m



Peso: 220 gr  
Unitalla  
6 bolsas



CÓDIGO	PRECIO	INNER	MASTER
TPCH1208	\$ 200.00	10	100

## Chaleco de seguridad con cierre amarillo

Poliéster 100% respirable  
Resistente al sol  
Cintas reflejantes dobles 3/4"  
Uso día y noche:  
Vista día 40 m  
Vista noche 150 m



Peso: 118 gr  
Unitalla



CÓDIGO	PRECIO	INNER	MASTER
TPCH1210	\$ 82.00	10	100

## Chaleco de seguridad con velcro amarillo

Poliéster 100% respirable  
Resistente al sol  
Cintas reflejantes plateadas 2"  
Uso día y noche:  
Vista día 40 m  
Vista noche 150 m



Peso: 118 gr  
Unitalla



CÓDIGO	PRECIO	INNER	MASTER
TPCH1212	\$ 75.00	10	100

## Faja con tirantes ajustables y soporte lumbar



CÓDIGO	DESCRIPCIÓN	PRECIO	INN.	MAS.
TPFE418	Chica	\$ 213.00	1	36
TPFE419	Mediana	\$ 213.00	1	36
TPFE420	Grande	\$ 213.00	1	36
TPFE421	Extra grande	\$ 213.00	1	36
TPFE422	Ext. Ext / Grande	\$ 213.00	1	36

El aspecto, empaque, inner o master de los productos puede variar sin previo aviso debido a la innovación continua de nuestras marcas.

## Arnés de cuerpo completo

Materiales resistentes a químicos, abrasivos y rayos UV

Cinta de 4 cm fabricada en poliéster

Herraje de acero forjado

Resiste 2,300 kg



CÓDIGO	DESCRIPCIÓN	PRECIO	INN.	MAS.
TPAC1225	1 Anillo "D"	\$ 580.00	2	12
TPAC1227	3 Anillos "D"	\$ 600.00	2	12
TPAC1228	5 Anillos "D"	\$ 660.00	2	12
TPAC1226	3 Anillos "D" (3 posiciones)	\$ 630.00	2	12

## Ancla de conexión

Para unir el dispositivo de conexión al punto de anclaje

Herraje de acero forjado

Poliéster de alta resistencia

Materiales resistentes a químicos, abrasión y rayos UV

Resiste 2,300 kg

1 Anillo "D"



CÓDIGO	PRECIO	INNER	MASTER
TPAC1233	\$ 150.00	2	12

## Bota jardín negra

100% PVC

Para jardinería y agricultura

Especial para ambientes húmedos

Gran durabilidad



CÓDIGO	DESC.	PRECIO	INNER	MASTER
TPBJ362	No. 25	\$ 165.00	1 Par	12 Pares
TPBJ363	No. 26	\$ 165.00	1 Par	12 Pares
TPBJ364	No. 27	\$ 165.00	1 Par	12 Pares
TPBJ365	No. 28	\$ 165.00	1 Par	12 Pares
TPBJ366	No. 29	\$ 165.00	1 Par	12 Pares
TPBJ367	No. 30	\$ 165.00	1 Par	8 Pares

## Línea de vida con absorbedor de impacto "Y" Doble gancho

Ganchos con sistema de bloqueo

Absorbe el impacto manteniendo la fuerza de la caída por debajo de los 400 kg

Herrajes de acero forjado

Poliéster de alta resistencia

Materiales resistentes a químicos, abrasión y rayos UV

Ancho de cinta: 30 mm

Largo 1.8 m



CÓDIGO	PRECIO	INNER	MASTER
TPLY1237	\$ 1,250.00	2	12

## Cable de posicionamiento 2 m

Ganchos de acero forjado con doble seguro

Para conectarse a anillos "D" laterales y limitar el movimiento

Cuerda de poliéster de alta resistencia

Diámetro 17 mm

Resiste 2,200 kg



CÓDIGO	PRECIO	INNER	MASTER
TPCP1234	\$ 350.00	2	24

## Bota sanitaria blanca

100% PVC

Suela nitrilo antiderrapante que impide la acumulación de residuos

Para industria alimentaria y laboratorios

Gran durabilidad



CÓDIGO	DESC.	PRECIO	INNER	MASTER
TPBS368	No. 25	\$ 225.00	1 Par	12 Pares
TPBS370	No. 26	\$ 225.00	1 Par	12 Pares
TPBS371	No. 27	\$ 225.00	1 Par	12 Pares
TPBS372	No. 28	\$ 225.00	1 Par	12 Pares
TPBS373	No. 29	\$ 225.00	1 Par	12 Pares
TPBS374	No. 30	\$ 225.00	1 Par	8 Pares

## Línea de vida con absorbedor de impacto

Ganchos con sistema de bloqueo

Absorbe el impacto manteniendo la fuerza de la caída por debajo de los 400 kg

Herrajes de acero forjado

Poliéster de alta resistencia

Materiales resistentes a químicos, abrasión y rayos UV

Ancho de cinta: 30 mm

Largo 1.8 m



CÓDIGO	PRECIO	INNER	MASTER
TPLY1236	\$ 500.00	2	12

## Rodilleras profesionales (Par)

100% Poliéster

2 Bandas elásticas con velcro

Relleno de poliuretano

Superficie rígida



6 respiraciones



CÓDIGO	PRECIO	INNER	MASTER
TPRL1368	\$ 280.00	1	20

## Rodilleras (Par)

Goma con forro poliéster

Centro acojinado

Copa de plástico



CÓDIGO	PRECIO	INNER	MASTER
TPKP2	\$ 120.00	6	48

## Zapato industrial con casquillo

Punta de acero 200 Joultes de resistencia

Entre-suela de acero

Suela anti-derrapante

Absorción de impactos

Resistente a aceite, petróleo, y químicos

Corte 100% vacuno

Plantilla de látex



CÓDIGO	DESC.	PRECIO	INNER	MASTER
TPZI1342	No. 22	\$ 590.00	1 Par	10 Pares
TPZI1343	No. 23	\$ 590.00	1 Par	10 Pares
TPZI1344	No. 24	\$ 590.00	1 Par	10 Pares
TPZI1345	No. 25	\$ 590.00	1 Par	10 Pares
TPZI1346	No. 26	\$ 590.00	1 Par	10 Pares
TPZI1347	No. 27	\$ 590.00	1 Par	10 Pares
TPZI1348	No. 28	\$ 590.00	1 Par	10 Pares
TPZI1349	No. 29	\$ 590.00	1 Par	10 Pares
TPZI1350	No. 30	\$ 590.00	1 Par	10 Pares

**Careta protectora**



CÓDIGO	PRECIO	INNER	MASTER
TPHFS	\$ 200.00	1	6

**Lentes de protección**

Protección UV  
Antirayado



CÓDIGO	DESC.	PRECIO	INN.	MAS.
TPEPG	M. Policarbonato	\$ 33.00	12	144
TPEPG1	Tricolor	\$ 35.00	12	144

**Goggles de seguridad para trabajo**



Ventilación directa



CÓDIGO	PRECIO	INNER	MASTER
TPGOGGLE	\$ 31.00	24	192

**Goggles de seguridad con válvulas**

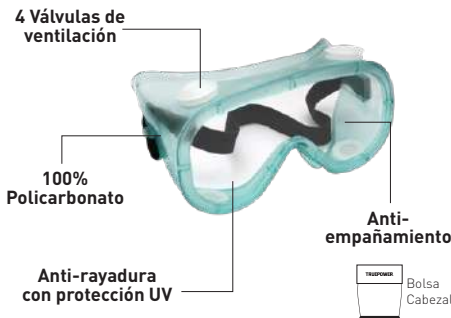

CÓDIGO	PRECIO	INNER	MASTER
TPGS1119	\$ 48.00	6	48

**Goggles de seguridad profesionales**



CÓDIGO	PRECIO	INNER	MASTER
TPGS1120	\$ 119.00	6	48

**Lentes para protección**



CÓDIGO	PRECIO	INNER	MASTER
TPLP606	\$ 38.00	24	120

**Lentes para protección deportivo transparente**



CÓDIGO	DESC.	PRECIO	INNER	MASTER
TPLT340	Negro	\$ 52.00	12	120
TPLT341	Amarillo	\$ 52.00	12	120
TPLT342	Verde	\$ 52.00	12	120
TPLT343	Azul	\$ 52.00	12	120

**Lentes de seguridad**



CÓDIGO	DESC.	PRECIO	INNER	MASTER
TPLP169	Obscuros	\$ 26.00	12	120
TPLP168	Claros	\$ 26.00	12	120

**Casco de seguridad**



CÓDIGO	DESCRIPCIÓN	PRECIO	INNER	MASTER
TPSHTR	Rojo	\$ 90.00	1	30
TPSHTB	Azul	\$ 90.00	1	30
TPSHTY	Amarillo	\$ 90.00	1	30
TPSHTW	Blanco	\$ 90.00	1	30
TPSHTO	Naranja	\$ 90.00	1	30

**Cinta barricada (0.04 mm x 75 mm x 305 m)**



CÓDIGO	DESC.	PRECIO	INN.	MAS.
CBPE	Peligro	\$ 150.00	1	20
CBPR	Precaución	\$ 150.00	1	20
CBPP	Prohibido el paso	\$ 150.00	1	20

**Cubrebocas 50 Piezas**

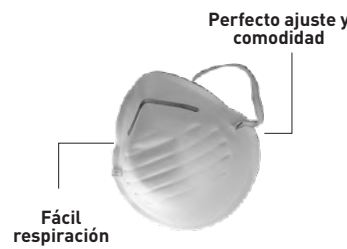

CÓDIGO	PRECIO	INNER	MAS.
TPMASK50B	\$ 99.00	1	20

**Tapón auditivo**



CÓDIGO	PRECIO	INNER	MASTER
TPTA557	\$ 10.00	12	96

**Juego de equipo de seguridad 3 piezas**



CÓDIGO	PRECIO	INNER	MASTER
TPDMSG3	\$ 110.00	1	12

El aspecto, empaque, inner o master de los productos puede variar sin previo aviso debido a la innovación continua de nuestras marcas.



## Guante de nylon recubierto de nitrilo (par)



Uso general



CÓDIGO	DESCRIPCIÓN	PRECIO	INNER	MASTER
TPGN313	Chico 8"	\$ 22.00	12	144
TPGN314	Mediano 9"	\$ 22.00	12	144
TPGN315	Grande 10"	\$ 22.00	12	144

## Guante de poliéster elástico recubierto con látex (par)

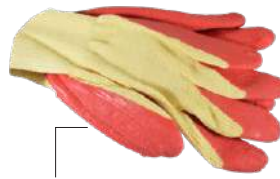

Uso general



CÓDIGO	DESCRIPCIÓN	PRECIO	INNER	MASTER
TPGP1034	Chico	\$ 50.00	12	144
TPGP1035	Mediano	\$ 50.00	12	144
TPGP1036	Grande	\$ 50.00	12	144

## Guante de látex doméstico (par)



CÓDIGO	DESCRIPCIÓN	PRECIO	INNER	MASTER
TPGD1688	Chico	\$ 18.00	12	240
TPGD1689	Mediano	\$ 18.00	12	240
TPGD1690	Grande	\$ 18.00	12	240
TPGD1691	Extra grande	\$ 18.00	12	240

## Guantes de vinilo desechables 100 piezas



CÓDIGO	DESC.	PRECIO	INNER	MASTER
TPGV1692	Mediano	\$ 120.00	1	10
TPGV1693	Grande	\$ 120.00	1	10

## Guante industrial (par)



Resistente a químicos



CÓDIGO	DESCRIPCIÓN	PRECIO	INNER	MASTER
TPGI1686	Grande	\$ 114.00	1	72
TPGI1687	Extra grande	\$ 114.00	1	72

## Guantes de carnaza usos generales 10 1/2" (par)



CÓDIGO	PRECIO	INNER	MASTER
TPGC774	\$ 55.00	10	60

## Guantes de carnaza para argonero 10 1/2" (par)

Manejo de materiales



Uso general



CÓDIGO	PRECIO	INNER	MASTER
TPGC775	\$ 65.00	10	60

## Guante de carnaza y loneta con refuerzo 10 1/2" (par)

Manejo de materiales



Uso general



CÓDIGO	PRECIO	INNER	MASTER
TPGC776	\$ 75.00	12	60

## Guante de carnaza para soldador largo 14" (par)



CÓDIGO	PRECIO	INNER	MASTER
TPGC777	\$ 130.00	10	60

## Guante de algodón recubierto de hule (par)

Uso en la construcción



CÓDIGO	PRECIO	INNER	MASTER
TPGA1037	\$ 80.00	12	120

## Guante de algodón elástico con puntos PVC palma y dorso (par)

Excelente agarre de materiales resbalosos



CÓDIGO	PRECIO	INNER	MASTER
TPGA1039	\$ 22.00	12	72

## Guante de algodón recubierto de nitrilo (par)

Ambientes grasosos y húmedos



CÓDIGO	PRECIO	INNER	MASTER
TPGA1038	\$ 52.00	12	144

**Cinta de fibra de vidrio**

Para uniones y reparaciones en paneles de cemento y yeso



25% más resistente



CÓDIGO	DESCRIPCIÓN	PRECIO	INN.	MAS.
CFV2250	2" x 250 ft (50 mm x 76.2 m)	\$ 86.00	1	24
CFV4150	4" x 150 ft (101.6 mm x 45.8 m)	\$ 103.00	1	27

**Cinta para panel de yeso**

Diseñada para el tratamiento y acabado de las uniones del panel de yeso



CÓDIGO	DESCRIPCIÓN	PRECIO	INN.	MAS.
CT2125	2" x 125 ft (50 mm x 37.5 m)	\$ 34.00	1	54
CT2250	2" x 250 ft (50 mm x 77.1 m)	\$ 64.00	1	24
CT2500	2" x 500 ft (50 mm x 152.4 m)	\$ 126.00	1	10

**Cinta de aluminio**

Protege ductos contra daño por calor



Adherencia en partes irregulares

CÓDIGO	DESCRIPCIÓN	PRECIO	INN.	MAS.
CA210	2" x 10 yd(9.1 m)	\$ 42.00	1	24
CA230	2" x 30 yd(27.4m)	\$ 110.00	1	24
CIAL2	2" x 50 yd(41.5m)	\$ 175.00	1	24

**Cinta antiderrapante 2" x 5 m**

Adhesivo acrílico



CÓDIGO	DESCRIPCIÓN	PRECIO	INNER	MASTER
CAN5	Negra	\$ 130.00	1	36
CAC5	Café	\$ 130.00	1	36

**Cinta poliken para tubería 2" x 30 m**

Alta protección contra la humedad



CÓDIGO	PRECIO	INNER	MASTER
CIP2	\$ 130.00	1	24

**Cinta gris para ducto 2"**

Alta protección contra la humedad



Alta adhesión

Antiestiramiento



CÓDIGO	DESCRIPCIÓN	PRECIO	INNER	MASTER
CD210	10 yds(9.1 m)	\$ 30.00	1	48
CD230	30 yds(27.4 m)	\$ 76.00	1	24
CD250	50 yds(45.7 m)	\$ 124.00	4	24
CD260	60 yds(54.8 m)	\$ 150.00	1	24

**Rollo torque stretch film 18" 366 m**

Calibre 50



CÓDIGO	PRECIO	INNER	MASTER
RSF180	\$ 180.00	1	4

**Cinta de montaje 19 mm**

Cinta de espuma con doble adhesivo



Para uso general



CÓDIGO	DESCRIPCIÓN	PRECIO	INNER	MASTER
CINM25	2.5 m	\$ 18.00	12	96
CINM50	5 m	\$ 25.00	12	48

**Cinta masking tape uso general (60 yds / 49.8 m) Empaquetado individual**

Para uso general



CÓDIGO	DESCRIPCIÓN	PRECIO	INNER	MASTER
CMT34	3/4"	\$ 28.00	1	48
CMT1	1"	\$ 33.00	1	36
CMT112	1 1/2"	\$ 49.00	1	24
CMT2	2"	\$ 64.00	1	24

**Pistola aplicadora de tape reforzada**



CÓDIGO	PRECIO	INNER	MASTER
PATR	\$ 140.00	1	24

**Cinta canela**

Adhesivo acrílico base agua



Ideales para polietileno



CÓDIGO	DESCRIPCIÓN	PRECIO	INNER	MASTER
CC250	2" x 50 m	\$ 17.00	6	72
CC2100	2" x 100 m	\$ 33.00	6	36
CC3100	3" x 100 m	\$ 50.00	1	24

**Cinta transparente**

Adhesivo acrílico base agua

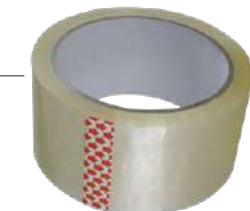

Ideales para polietileno



CÓDIGO	DESCRIPCIÓN	PRECIO	INNER	MASTER
CT250	2" x 50 m	\$ 17.00	6	72
CT2100	2" x 100 m	\$ 33.00	6	36
CT3100	3" x 100 m	\$ 50.00	1	24

El aspecto, empaque, inner o master de los productos puede variar sin previo aviso debido a la innovación continua de nuestras marcas.

**Lona multiusos 8 x 10 hilos**

**CARACTERÍSTICAS**

- Bordes con doble costura, más resistentes
- Tela de polietileno de 8 x 10 hilos en cada pulgada
- Polietileno de 40 mm impermeable por ambos lados
- 90 gramos por metro cuadrado de peso
- Espesor .12 mm
- Resistente a los rayos UV y al agua
- Ojillos de aluminio trenzados que refuerzan su estructura



Azul

Amarillo

Verde



AZUL	AMARILLO	VERDE	DESCRIPCIÓN	PRECIO	INNER	MASTER
TPL57	TP1100	TP1125	5 x 7 ft (1.50 x 2.10 m)	\$ 53.00	1	50
TPL68	TP1101	TP1126	6 x 8 ft (1.80 x 2.40 m)	\$ 74.00	1	40
TPL610	TP1102	TP1127	6 x 10 ft (1.80 x 3 m)	\$ 92.00	1	35
TPL6510	TP1103	TP1128	6.5 x 10 ft (2.00 x 3 m)	\$ 108.00	1	35
TPL810	TP1104	TP1129	8 x 10 ft (2.40 x 3 m)	\$ 123.00	1	25
TPL1010	TP1105	TP1130	10 x 10 ft (3.00 x 3.00 m)	\$ 152.00	1	20
TPL912	TP1106	TP1131	9 x 12 ft (2.70 x 3.60 m)	\$ 165.00	1	20
TPL1012	TP1107	TP1132	10 x 12 ft (3.00 x 3.60 m)	\$ 183.00	1	18
TPL1013	TP1108	TP1133	10 x 13.1 ft (3.00 x 4 m)	\$ 199.00	1	18
TPL1212	TP1109	TP1134	12 x 12 ft (3.60 x 3.60 m)	\$ 220.00	1	15
TPL1016	TP1110	TP1135	10 x 16 ft (3.00 x 4.80 m)	\$ 245.00	1	12
TPL1216	TP1111	TP1136	12 x 16 ft (3.60 x 4.80 m)	\$ 292.00	1	10
TPL1414	TP1112	TP1137	14 x 14 ft (4.20 x 4.20 m)	\$ 300.00	1	10
TPL1020	TP1113	TP1138	10 x 20 ft (3.00 x 6.00 m)	\$ 307.00	1	10
TPL1416	TP1114	TP1139	14 x 16 ft (4.20 x 4.80 m)	\$ 344.00	1	10
TPL1220	TP1115	TP1140	12 x 20 ft (3.60 x 6.00 m)	\$ 369.00	1	8
TPL1418	TP1116	TP1141	14 x 18 ft (4.20 x 5.40 m)	\$ 385.00	1	8
TPL1420	TP1117	TP1142	14 x 20 ft (4.20 x 6.00 m)	\$ 427.00	1	8
TPL1620	TP1118	TP1143	16 x 20 ft (4.80 x 6.00 m)	\$ 487.00	1	7
TPL2020	TP1119	TP1144	20 x 20 ft (6.00 x 6.00 m)	\$ 610.00	1	5
TPL1824	TP1120	TP1145	18 x 24 ft (5.40 x 7.20 m)	\$ 660.00	1	5
TPL2030	TP1121	TP1146	20 x 30 ft (6.00 x 9.00 m)	\$ 920.00	1	3
TPL2040	TP1122	TP1147	20 x 40 ft (6.00 x 12 m)	\$ 1,140.00	1	2
TPL2041	TP1123	TP1148	29.5 x 45.9 ft (9.00 x 14 m)	\$ 1,965.00	1	2

**Lona uso rudo 14 x 14 hilos**

**CARACTERÍSTICAS**

- Bordes con doble costura, más resistentes
- Tela de polietileno de 14 x 14 hilos en cada pulgada
- Polietileno de 50 mm impermeable por ambos lados
- 160 gramos por metro cuadrado de peso
- Espesor .25 mm
- Resistente a los rayos UV y al agua
- Ojillos de aluminio trenzados que refuerzan su estructura



Plata / negro

Azul / negro



PLATA / NEGRO	AZUL / NEGRO	DESCRIPCIÓN	PRECIO	INNER	MASTER
TPLR57	TP1150	5 x 7 ft (1.50 x 2.10 m)	\$ 89.00	1	35
TPLR68	TP1151	6 x 8 ft (1.80 x 2.40 m)	\$ 123.00	1	25
TPLR658	TP1152	6 x 8 ft (2.00 x 3.00 m)	\$ 179.00	1	25
TPLR810	TP1153	8 x 10 ft (2.40 x 3.00 m)	\$ 204.00	1	15
TPLR1010	TP1154	10 x 10 ft (3.00 x 3.00 m)	\$ 255.00	1	12
TPLR1012	TP1155	10 x 12 ft (3.00 x 3.60 m)	\$ 306.00	1	10
TPLR1013	TP1156	9.8 x 13.1 ft (3.00 x 4.00 m)	\$ 332.00	1	10
TPLR1016	TP1157	9.8 x 16.4 ft (3.00 x 5.00 m)	\$ 434.00	1	6
TPLR1216	TP1158	12 x 16 ft (3.60 x 4.80 m)	\$ 490.00	1	6
TPLR1316	TP1159	13.1 x 16.4 ft (4.00 x 5.00 m)	\$ 564.00	1	6
TPLR1319	TP1160	13.1 x 19.6 ft (4.00 x 6.00 m)	\$ 663.00	1	6
TPLR1820	TP1161	18 x 20 ft (4.80 x 6.00 m)	\$ 918.00	1	3
TPLR2020	TP1162	20 x 20 ft (6.00 x 6.00 m)	\$ 1,020.00	1	3
TPLR2030	TP1163	20 x 30 ft (6.00 x 9.00 m)	\$ 1,430.00	1	2

Letrero de advertencia de estireno con adhesivo 25 x 34 cm  
**SE RENTA**

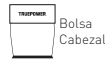

CÓDIGO	PRECIO	INNER	MASTER
TPS201	\$ 130.00	5	50

Letrero de advertencia de estireno con adhesivo 25 x 34 cm  
**SE VENDE**



CÓDIGO	PRECIO	INNER	MASTER
TPS202	\$ 130.00	5	50

Letrero de advertencia de estireno con adhesivo 21 x 28 cm  
**RUTA DE EVACUACIÓN DERECHA**



CÓDIGO	PRECIO	INNER	MASTER
TPS203	\$ 95.00	5	50

Letrero de advertencia de estireno con adhesivo 21 x 28 cm  
**RUTA DE EVACUACIÓN IZQUIERDA**



CÓDIGO	PRECIO	INNER	MASTER
TPS204	\$ 95.00	5	50

Letrero de advertencia de estireno con adhesivo 21 x 28 cm  
**SALIDA DE EMERGENCIA**



CÓDIGO	PRECIO	INNER	MASTER
TPS205	\$ 95.00	5	50

Letrero de advertencia de estireno con adhesivo  
**ENTRADA Y SALIDA 24 HRS**



CÓDIGO	DESCRIPCIÓN	PRECIO	INNER	MASTER
TPS206	25 x 34 cm	\$ 130.00	5	50
TPS278	34 x 50 cm	\$ 219.00	5	25

Letrero de advertencia de estireno con adhesivo  
**SE USARÁ GRUA**

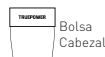

CÓDIGO	DESCRIPCIÓN	PRECIO	INNER	MASTER
TPS207	25 x 34 cm	\$ 130.00	5	50
TPS279	34 x 50 cm	\$ 219.00	5	25

Letrero de advertencia de estireno con adhesivo 21 x 28 cm  
**BOTIQUÍN**



CÓDIGO	PRECIO	INNER	MASTER
TPS208	\$ 90.00	5	50

Letrero de advertencia de estireno con adhesivo 21 x 28 cm  
**DEMUESTRA TU EDUCACIÓN...**



CÓDIGO	PRECIO	INNER	MASTER
TPS209	\$ 90.00	5	50

El aspecto, empaque, inner o master de los productos puede variar sin previo aviso debido a la innovación continua de nuestras marcas.

Letrero de advertencia de estireno con adhesivo 21 x 28 cm  
**DEPOSITE LA BASURA EN SU LUGAR**



CÓDIGO	PRECIO	INNER	MASTER
TPS210	\$ 90.00	5	50

Letrero de advertencia de estireno con adhesivo 21 x 28 cm  
**LÁVESE LAS MANOS DESPUES DE IR AL BAÑO**



CÓDIGO	PRECIO	INNER	MASTER
TPS211	\$ 90.00	5	50

Letrero de advertencia de estireno con adhesivo 21 x 28 cm  
**USO OBLIGATORIO DE EQUIPO DE SEGURIDAD**



CÓDIGO	PRECIO	INNER	MASTER
TPS212	\$ 90.00	5	50

Letrero de advertencia de estireno con adhesivo 19 x 19 cm  
**NO FUMAR**



CÓDIGO	PRECIO	INNER	MASTER
TPS190	\$ 75.00	5	100

Letrero de advertencia de estireno con adhesivo 19 x 19 cm  
**SOLO PERSONAL AUTORIZADO**



CÓDIGO	PRECIO	INNER	MASTER
TPS192	\$ 75.00	5	100

Letrero de advertencia de estireno con adhesivo  
**PROHIBIDO EL PASO**



CÓDIGO	DESCRIPCIÓN	PRECIO	INNER	MASTER
TPS191	19 x 19 cm	\$ 75.00	5	100
TPS280	34 x 34 cm	\$ 165.00	5	100

Letrero de advertencia de estireno con adhesivo 19 x 19 cm  
**EXTINTOR**



CÓDIGO	PRECIO	INNER	MASTER
TPS193	\$ 75.00	5	100

Letrero de advertencia de estireno con adhesivo 19 x 19 cm  
**CABALLEROS**



CÓDIGO	PRECIO	INNER	MASTER
TPS194	\$ 75.00	5	100

Letrero de advertencia de estireno con adhesivo 19 x 19 cm  
**DAMAS**



CÓDIGO	PRECIO	INNER	MASTER
TPS195	\$ 75.00	5	100

**Letrero de advertencia de estireno con adhesivo 19 x 19 cm DISCAPACITADOS**



CÓDIGO	PRECIO	INNER	MASTER
TPS196	\$ 75.00	5	100

**Letrero de advertencia de estireno con adhesivo 19 x 19 cm MANTENER CERRADA ESTA PUERTA**



CÓDIGO	PRECIO	INNER	MASTER
TPS197	\$ 75.00	5	100

**Letrero de advertencia de estireno con adhesivo 19 x 19 cm FLECHA DIAGONAL**



CÓDIGO	PRECIO	INNER	MASTER
TPS198	\$ 75.00	5	100

**Letrero de advertencia de estireno con adhesivo 19 x 19 cm FLECHA HORIZONTAL**



CÓDIGO	PRECIO	INNER	MASTER
TPS199	\$ 75.00	5	100

**Letrero de advertencia de estireno 28 x 12 cm doble vista con ventosa con gancho ABIERTO/CERRADO**



CÓDIGO	PRECIO	INNER	MASTER
TPS200	\$ 130.00	5	25

**Letrero de advertencia de estireno con adhesivo 25 x 34 cm ALTO VOLTAJE**



CÓDIGO	PRECIO	INNER	MASTER
TPS1357	\$ 130.00	5	50

**Letrero de advertencia de estireno con adhesivo 19 x 19 cm ZONA WIFI**



CÓDIGO	PRECIO	INNER	MASTER
TPS213	\$ 75.00	1	5

**Letrero de advertencia de estireno con adhesivo 19 x 19 cm PROHIBIDO ANIMALES**



CÓDIGO	PRECIO	INNER	MASTER
TPS214	\$ 75.00	1	5

**Letrero de advertencia de estireno con adhesivo 19 x 19 cm ESCALERAS**



CÓDIGO	PRECIO	INNER	MASTER
TPS215	\$ 75.00	1	5

El aspecto, empaque, inner o master de los productos puede variar sin previo aviso debido a la innovación continua de nuestras marcas.

# LETREROS DE ADVERTENCIA

**TRUEPOWER**

Letrero de advertencia de estireno con adhesivo 19 x 19 cm  
**SANITARIOS**



CÓDIGO	PRECIO	INNER	MASTER
TPS216	\$ 75.00	1	5

Letrero de advertencia de estireno con adhesivo 19 x 19 cm  
**FAVOR DE APAGAR SU CELULAR**



CÓDIGO	PRECIO	INNER	MASTER
TPS217	\$ 75.00	1	5

Letrero de advertencia de estireno con adhesivo 19 x 19 cm  
**NO SE FIA**



CÓDIGO	PRECIO	INNER	MASTER
TPS218	\$ 75.00	1	5

Letrero de advertencia de estireno con adhesivo 21 x 28 cm  
**PROHIBIDO ALIMENTOS**



CÓDIGO	PRECIO	INNER	MASTER
TPS219	\$ 85.00	1	5

Letrero de advertencia de estireno con adhesivo 21 x 28 cm  
**SISTEMA DE APARTADO**



CÓDIGO	PRECIO	INNER	MASTER
TPS220	\$ 85.00	1	5

Letrero de advertencia de estireno con adhesivo 25 x 34 cm  
**SISMOS-INCENDIOS**



CÓDIGO	PRECIO	INNER	MASTER
TPS221	\$ 130.00	1	5

Letrero de advertencia de estireno con adhesivo 25 x 34 cm  
**MATERIALES INFLAMABLES**



CÓDIGO	PRECIO	INNER	MASTER
TPS222	\$ 130.00	1	5

Letrero de advertencia de estireno con adhesivo 25 x 34 cm  
**ZONA VIDEOVIGILADA**



CÓDIGO	PRECIO	INNER	MASTER
TPS223	\$ 130.00	1	5

Letrero de advertencia de estireno con adhesivo 34 x 34 cm  
**PUNTO DE REUNION**

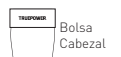

CÓDIGO	PRECIO	INNER	MASTER
TPS224	\$ 175.00	1	5

LETREROS DE ADVERTENCIA

El aspecto, empaque, inner o master de los productos puede variar sin previo aviso debido a la innovación continua de nuestras marcas.

**Juego de dados con matraca  
52 piezas**



Portafolio plástico

**CONTIENE**

- Matraca reversible de 177,8 mm (7") mando de 9,5 mm (3/8")
- Matraca reversible de 288,6 mm (9") mando de 12,7 mm (1/2")
- Adaptador de 9,5 mm (3/8") a 6,35 mm (1/4")
- Barra de extensión de 76,2 mm (3") mando de 9,5 mm (3/8")
- Dado para bujía de 9,5 mm (3/8") x 15,88 mm (5/8")
- Disco de plástico de 9,5 mm (3/8") para ajuste de dado
- Desarmador para dado de 6,35 mm (1/4")
- 5 Puntos de desarmador
- 1 Cople
- 13 Dados de 6 puntos milimétricos mando de 6,35 mm (1/4")

4 mm	8 mm	12 mm	4.5 mm
5 mm	9 mm	3 mm	5.5 mm
6 mm	10 mm		6.5 mm
7 mm	11 mm		

- 12 Dados de 6 puntos estándar mando de 6,35 mm (1/4")

3.97 mm (5/32")	7.14 mm (9/32")	10.32 mm (13/32")
4.76 mm (3/16")	7.94 mm (5/16")	11.11 mm (7/16")
5.56 mm (7/32")	8.73 mm (11/32")	11.91 mm (15/32")
6.35 mm (1/4")	9.53 mm (3/8")	12.7 mm (1/2")

- 3 Dados de 8 puntas estándar mando de 6,35 mm (1/4")

6.35 mm (1/4")	7.94 mm (5/16")	9.5 mm (3/8")
----------------	-----------------	---------------

- 3 Dados de 6 puntas estándar mando de 9,5 mm (3/8")

14.29 mm (9/16")	11.1 mm (7/16")	12.70 mm (1/2")
------------------	-----------------	-----------------

- 3 Dados de 6 puntas milimétricas mando de 9,5 mm (3/8")

11 mm	12 mm	13 mm
-------	-------	-------

- 4 Dados de 6 puntas estándar mando de 12,7 mm (1/2")

15.88 mm (5/8")	19.05 mm (3/4")	17.46 mm (11/16")
20.64 mm (13/16")		

CÓDIGO	PRECIO	INNER	MASTER
TPSS52B	\$ 375.00	1	6

**Juego de dados con matraca  
40 piezas**



Portafolio plástico

**CONTIENE**

- Matraca reversible de 203,2mm (7") mando de 9,5mm (3/8")
- Barra de extensión de 76,2 mm (3") mando de 9,5 mm (3/8")
- Adaptador de 9,5 mm (3/8") a 6,35 mm (1/4")
- Dado para bujía de 15.87 mm (5/8")
- Disco de plástico de 9,5 mm (3/8") para ajuste de dado
- Desarmador para dado de 6,35 mm (1/4")
- 3 Dados de 8 puntas milimétricas mando de 6,4 mm (1/4")

6.35 mm (1/4")	7.94 mm (5/16")	9.5 mm (3/8")
----------------	-----------------	---------------

- 12 Dados de 6 puntos estándar mando de 6,35 mm (1/4")

3.97 mm (5/32")	7.14 mm (9/32")	10.32 mm (13/32")
4.76 mm (3/16")	7.94 mm (5/16")	11.11 mm (7/16")
5.56 mm (7/32")	8.73 mm (11/32")	11.91 mm (15/32")
6.35 mm (1/4")	9.53 mm (3/8")	12.7 mm (1/2")

- 3 Dados de 6 puntas estándar mando de 9,5 mm (3/8")

14.46 mm (9/16")	17.46 mm (11/16")	19.05 mm (3/4")
------------------	-------------------	-----------------

- 3 Dados de 6 puntas milimétricas mando de 9,5 mm (3/8")

14 mm	16 mm	17 mm
-------	-------	-------

- 12 Dados de 6 puntas milimétricas mando de 6,35 mm (1/4")

4 mm	5.5 mm	8 mm	11 mm
4.5 mm	6 mm	9 mm	12 mm
5 mm	7 mm	10 mm	13 mm

CÓDIGO	PRECIO	INNER	MASTER
TPSS40C	\$ 180.00	1	10

**Juego de dados con matraca  
25 piezas**



Portafolio plástico

**CONTIENE**

- Matraca reversible de 254mm (10") mando de 12,7mm (1/2")
- Barra de extensión de 254 mm (10") mando de 12,7 mm (1/2")
- Barra de extensión de 127 mm (5") mando de 12,7 mm (1/2")
- Berbiquí mando de 12,7 mm (1/2")
- Disco de plástico de 12,7 mm (1/2")
- Dado para bujía de 15.88 mm (5/8") mando de 12,7 mm (1/2")
- 18 dados 6 puntos estándar mando 12,7 mm (1/2")

3/8" (9,53 mm)	23/32" (18,26 mm)
7/16" (11,11 mm)	2/4" (19,05 mm)
15/32" (11,91 mm)	25/32" (19,84 mm)
1/2" (12,70 mm)	13/16" (20,64 mm)
9/16" (14,29 mm)	7/8" (22,23 mm)
19/32" (15,08 mm)	15/16" (23,81 mm)
5/8" (15,88 mm)	1" (25,40 mm)
21/32" (16,67 mm)	1 1/8" (28,58 mm)
11/16" (17,46 mm)	1/4" (31,75 mm)

CÓDIGO	PRECIO	INNER	MASTER
TPSS25A	\$ 560.00	1	5



El aspecto, empaque, inner o master de los productos puede variar sin previo aviso debido a la innovación continua de nuestras marcas.



## Matraca reversible cabeza redonda

Uso casero  
Longitud: 5"



Acero al carbono  
Mango moleteado  
Colgante con etiqueta

CÓDIGO	DESC.	PRECIO	INNER	MASTER
TPMCR14	1/4" x 4 3/4"	\$ 80.00	12	72
TPMCR38	3/8" x 7 1/2"	\$ 86.00	12	72
TPMCR12	1/2" x 8 1/2"	\$ 125.00	6	36

## Matraca reversible cabeza de pera

Uso profesional  
Liberación rápida  
Longitud: 8"



Acero al carbono  
Mango moleteado  
Colgante con etiqueta

CÓDIGO	DESC.	PRECIO	INNER	MASTER
TPMCP14	1/4" x 4 3/4"	\$ 160.00	12	72
TPMCP38	3/8" x 7"	\$ 190.00	12	72
TPMCP12	1/2" x 9"	\$ 230.00	6	24

## Mango articulado



Acero al cromo vanadio  
Mango moleteado  
Colgante con etiqueta

CÓDIGO	DESC.	PRECIO	INNER	MASTER
TPMA1130	3/8" x 6 3/4"	\$ 140.00	6	72
TPMA1129	1/2" x 16"	\$ 215.00	6	24

## Juego de extensiones 4 piezas

Base plástica

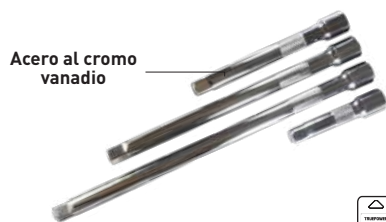

Acero al cromo vanadio  
Colgante con etiqueta

CÓDIGO	CUADRO	LARGO	PRECIO	INN.	MAS.
TPJE1169	1/4"	3", 4", 6" y 9"	\$ 150.00	6	72
TPJE1170	3/8"	3", 5", 8" y 10"	\$ 225.00	6	24
TPJE1171	1/2"	3", 5", 8" y 10"	\$ 300.00	6	24

## Nudo universal

Para lugares de difícil acceso



Acero al cromo vanadio  
Permite giros en ángulos de hasta 65°  
Colgante con etiqueta

CÓDIGO	DESC.	PRECIO	INNER	MASTER
TPNU1113	1/4"	\$ 46.00	12	120
TPNU1112	3/8"	\$ 62.00	12	120
TPNU1111	1/2"	\$ 85.00	10	60

## Adaptador reductor



Acero al cromo vanadio  
Colgante con etiqueta

CÓDIGO	DESCRIPCIÓN	PRECIO	INN.	MAS.
TPAD1164	3/8" H X 1/4" M	\$ 29.00	12	120
TPAD1165	1/2" H X 3/8" M	\$ 39.00	12	120

## Matraca reversible



Acero al cromo vanadio  
Engrane: cromo molibdeno  
Mango ergonómico  
Forro confort  
Colgante con etiqueta

CÓDIGO	DESC.	PRECIO	INNER	MASTER
TPMD1131	3/8" - 1/4"	\$ 170.00	6	60
TPMD1132	3/8" - 1/2"	\$ 265.00	6	48

## Matraca reversible barra ancha

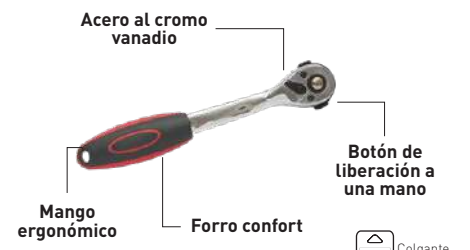

Acero al cromo vanadio  
Botón de liberación a una mano  
Mango ergonómico  
Forro confort  
Colgante con etiqueta

CÓDIGO	DESC.	PRECIO	INNER	MASTER
TPML1166	1/4"	\$ 192.00	6	48
TPML1167	3/8"	\$ 290.00	6	24
TPML1168	1/2"	\$ 390.00	6	24

## Juego de dados cuadro 3/8" 9 piezas

Dado de 0 a 6 puntas

Milimétrico STD

10 mm	3/8"
11 mm	7/16"
12 mm	1/2"
13 mm	9/16"
14 mm	5/8"
15 mm	11/16"
16 mm	3/4"
17 mm	13/16"
19 mm	7/8"

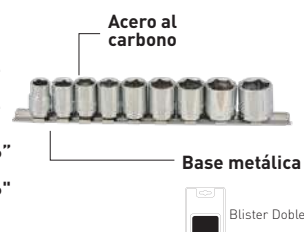

CÓDIGO	DESCRIPCIÓN	PRECIO	INNER	MASTER
TPJD38M	Milimétrico (10 - 18 mm)	\$ 150.00	6	24
TPJD38S	Estándar (3/8 - 7/8")	\$ 150.00	6	24

## Juego de afinación rígido 3/8" 4 piezas

Matraca cabeza redonda 3/8" x 6 3/4"

Extensión 3/8" x 2 3/4"

Dado para bujía 5/8", 6 puntas x 1/2"

Dado para bujía 1 3/16, 6 puntas x 1/2"



CÓDIGO	PRECIO	INNER	MASTER
TPJA4R	\$ 125.00	6	36

## Juego de afinación flexible 3/8" 4 piezas

Matraca cabeza redonda 3/8" x 9 1/2"

Extensión 3/8" x 6"

Dado para bujía 5/8", 6 puntas x 1/2"

Dado para bujía 1 3/16, 6 puntas x 1/2"



CÓDIGO	PRECIO	INNER	MASTER
TPJA4F	\$ 235.00	6	36

## Juego de dados cuadro 1/2" 8 piezas

Milimétrico STD

13 mm	1/2"
14 mm	9/16"
15 mm	5/8"
18 mm	11/16"
19 mm	3/4"
21 mm	13/16"
22 mm	7/8"
24 mm	15/16"

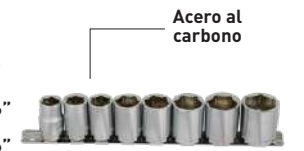

CÓDIGO	DESCRIPCIÓN	PRECIO	INNER	MASTER
TPJD12M	Milimétrico (13 - 24 mm)	\$ 175.00	6	18
TPJD12S	Estándar (1/2 - 15/16")	\$ 175.00	6	18

**Caja para herramientas 12"**

Con organizador y charola



Etiqueta

CÓDIGO	PRECIO	INNER	MASTER
TPTP1	\$ 191.00	1	24

**Caja para herramientas 16"**

Con organizador y charola



Etiqueta

CÓDIGO	PRECIO	INNER	MASTER
TPTP2	\$ 255.00	1	12

**Caja para herramientas 20"**

Con organizador y charola



Etiqueta

CÓDIGO	PRECIO	INNER	MASTER
TPTP3	\$ 320.00	1	4

**Juego de puntas cuadro 1/4" x 1" C/4 piezas**

Para uso manual o herramientas eléctricas  
Puntas: #0, #1, #2 y #3

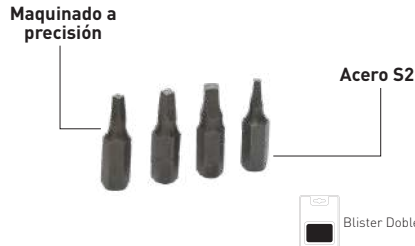

Blister Doble

CÓDIGO	PRECIO	INNER	MASTER
TPJP1173	\$ 30.00	12	72

**Juego de puntas cuadro 1/4" x 2" C/4 piezas**

Para uso manual o herramientas eléctricas  
Puntas: #0, #1, #2 y #3

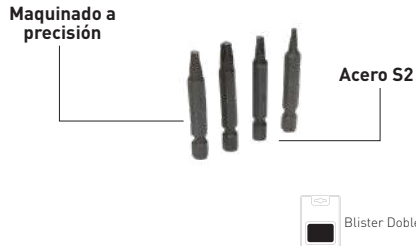

Blister Doble

CÓDIGO	PRECIO	INNER	MASTER
TPJP1174	\$ 40.00	12	72

**Juego de puntas profesionales dobles tipo cruz 2 1/2" 10 piezas**

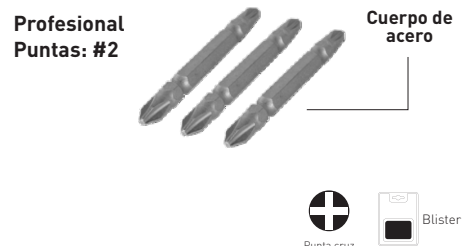

Punta cruz Blister

CÓDIGO	PIEZA	PAQUETE	INNER	MASTER
TPPB176	\$ 10.50	\$ 105.00	24	144

**Juego de puntas dobles tipo cruz 2 1/2" x 1/4" 10 piezas**

Puntas: #2

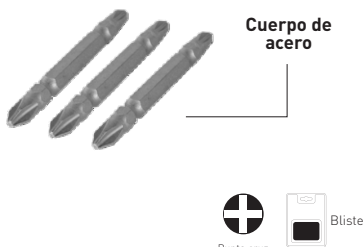

Punta cruz Blister

CÓDIGO	PRECIO	INNER	MASTER
TPPB177	\$ 70.00	24	144

**Juego de puntas profesionales dobles tipo cruz/plana 2 1/2" 10 piezas**

Profesional  
Punta cruz: #2  
Punta plana: 1/4"

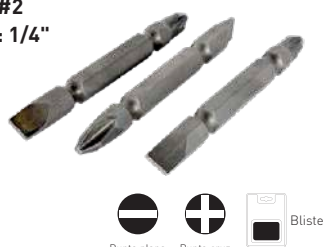

Punta plana Punta cruz Blister

CÓDIGO	PIEZA	PAQUETE	INNER	MASTER
TPPB175	\$ 11.00	\$ 110.00	24	144

**Juego de puntas dobles tipo cruz/plana 2 1/2" 10 piezas**

Punta cruz: #2  
Punta plana: 1/4"

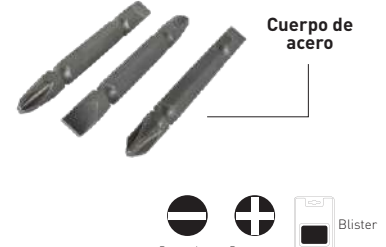

Punta plana Punta cruz Blister

CÓDIGO	PIEZA	PAQUETE	INNER	MASTER
TPDBFP214	\$ 6.50	\$ 65.00	12	144

**Juego de puntas para taladro tipo cruz 1" 10 piezas**

Puntas: #1



Punta cruz Blister

CÓDIGO	PIEZA	PAQUETE	INNER	MASTER
TPDBPH1	\$ 4.00	\$ 40.00	12	144

**Juego de puntas torx 2" 7 piezas**

Para uso manual o herramientas eléctricas  
Puntas: T10, T15, T20, T25, T27, T30, T40



Blister Doble

CÓDIGO	PRECIO	INNER	MASTER
TPJP1172	\$ 50.00	12	72

El aspecto, empaque, inner o master de los productos puede variar sin previo aviso debido a la innovación continua de nuestras marcas.

## Juego de llaves hexagonales 8 piezas

Milimétrica STD

1.5 mm	1/16"
2 mm	5/64"
2.5 mm	3/32"
3 mm	1/8"
4 mm	5/32"
5 mm	3/16"
5.5 mm	7/32"
6 mm	1/4"



CÓDIGO	DESCRIPCIÓN	PRECIO	INN.	MAS.
TPH310	STD (1/16" - 1/4")	\$ 26.00	12	96
TPH311	Milimétricas (1.5 - 6 mm)	\$ 26.00	12	96

## Juego de 13 llaves hexagonales con estuche

Milimétrica STD

1.3 mm	3/64"
1.5 mm	1/16"
2 mm	5/64"
2.5 mm	3/32"
3 mm	7/64"
3.5 mm	1/8"
4 mm	9/64"
4.5 mm	5/32"
5 mm	3/16"
5.5 mm	7/32"
6 mm	1/4"
8 mm	5/16"
10 mm	3/8"



CÓDIGO	DESCRIPCIÓN	PRECIO	INNER	MASTER
TPLA409	Milimétricas	\$ 92.00	12	48
TPLA410	STD	\$ 92.00	12	48

## Juego de 9 llaves hexagonales tipo navaja

Estándar:

5/64", 3/32",
7/64", 1/8",
9/64", 5/32",
3/16", 7/32",
1/4"

Milimétrica:  
1.2, 1.5, 2, 2.5,  
3, 4, 5, 5.5 y 6  
mm



CÓDIGO	DESC.	PRECIO	INN.	MAS.
TPHKW9S	STD	\$ 84.00	6	48
TPHKW9M	Milimétrica	\$ 84.00	6	48

## Juego desarmador "T" 22 piezas

CONTIENE

5 Puntas planas  
1/8" 5/32" 3/16",  
1/4", 9/32"

3 Puntas cruz #1,  
#2, #3

3 Puntas torx  
#15, #20, #30

9 Dados: 3/16",  
7/32", 1/4", 5/16",  
11/32", 3/8",  
15/32", 7/16",  
1/2"

1 Adaptador 1/4"



CÓDIGO	PRECIO	INNER	MASTER
TPTH22	\$ 62.00	12	48

## Llave para taladro universal Para uso en la mayoría de los taladros

#1 Llave 1/2"  
engrane 17/64"

#2 Llave 3/8"  
engrane 9/32"

#3 Llave 1/4"  
engrane 3/16"

#4 Llave 3/8"  
engrane 7/32"



CÓDIGO	PRECIO	INNER	MASTER
TP184	\$ 63.00	1	100

## Desarmador tipo pluma 4 puntas

2 Planas

1/8"
3,17 mm
5/32"
3,96 mm

2 Cruz

# 0
# 1



CÓDIGO	PRECIO	INNER	MASTER
TPDP493	\$ 30.00	12	144

## Juego de desarmador de precisión 7 piezas

T4, T5,
T6, T7,
T8, T9,
T10



CÓDIGO	PRECIO	INNER	MASTER
TPDP492	\$ 85.00	12	48

## Juego desarmador relojero 6 piezas

CANT. TIPO.

Desc.	
1.4 mm 2 mm	4
2.4 mm 3 mm	4
# 0 # 1	2



CÓDIGO	PRECIO	INNER	MASTER
TPDJ153	\$ 26.00	24	144

## Llave mandril 3/8" y 1/2"

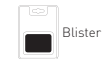

CÓDIGO	DESCRIPCIÓN	PRECIO	INN.	MAS.
TPLM610	3/8" Engrane 9/32"	\$ 21.00	30	300
TPLM611	1/2" Engrane 17/64"	\$ 22.00	20	200

## Juego de 8 llaves torx tipo navaja

Medidas:  
T-9, T-10, T-15,  
T-20, T-25,  
T-27, T-30,  
T-40



CÓDIGO	PRECIO	INNER	MASTER
TPTKW8	\$ 85.00	6	48

**NUEVA BROCA PARA CONCRETO SDS PRO**

**TRUEPOWER PRO**



**Poder destructivo sin rival**  
Carburo sólido, con un robusto diseño que proporciona velocidad y duración.

**Alta velocidad de perforación**  
Cortadores laterales inclinados que proporcionan una rápida perforación.

**Punta central activa**  
Proporciona un inicio de perforación rápida y exacta.

**Marca de desgaste**  
Asegura el diámetro del orificio taladrado.

**Cabeza compacta**  
Para una rápida remoción del polvo y mayor duración.

**Broca para concreto SDS PRO**

2 Cortadores carburo  
Cuerpo de acero al cromo

Producto **NUEVO**

**TRUEPOWER**



**TRUEPOWER PRO**  
**BROCA PARA CONCRETO SDS PRO**



CÓDIGO	DESCRIPCIÓN	PRECIO	INNER	MASTER
TP1091	1/4 x 4 (6 x 110 mm)	\$ 20.00	10	200
TP1092	1/4 x 6 (6 x 160 mm)	\$ 23.00	10	200
TP1093	1/4 x 8 (6 x 210 mm)	\$ 31.00	10	200
TP1094	1/4 x 10 (6 x 260 mm)	\$ 38.00	10	200
TP1095	5/16 x 6 (8 x 160 mm)	\$ 25.00	10	200
TP1096	5/16 x 12 (8 x 310 mm)	\$ 40.00	5	100
TP1097	3/8 x 6 (10 x 160 mm)	\$ 28.00	10	200
TP1098	3/8 x 12 (10 x 310 mm)	\$ 44.00	5	100
TP1099	3/8 x 18 (10 x 460 mm)	\$ 70.00	5	100
TP1170	7/16 x 6 (12 x 160 mm)	\$ 30.00	10	200
TP1171	7/16 x 12 (12 x 310 mm)	\$ 51.00	5	100
TP1172	1/2 x 6 (13 x 160 mm)	\$ 46.00	10	200
TP1173	1/2 x 12 (13 x 310 mm)	\$ 66.00	5	100
TP1174	1/2 x 18 (13 x 460 mm)	\$ 90.00	5	100
TP1175	9/16 x 6 (14 x 160 mm)	\$ 44.00	10	100
TP1176	9/16 x 12 (14 x 310 mm)	\$ 75.00	5	100
TP1177	5/8 x 8 (16 x 210 mm)	\$ 60.00	10	100
TP1178	5/8 x 12 (16 x 310 mm)	\$ 80.00	5	50
TP1179	5/8 x 24 (16 x 600 mm)	\$ 170.00	2	25
TP1180	3/4 x 8 (18 x 210 mm)	\$ 85.00	10	50
TP1181	3/4 x 12 (18 x 310 mm)	\$ 108.00	5	50
TP1182	3/4 x 18 (18 x 460 mm)	\$ 160.00	5	25
TP1183	7/8 x 8 (22 x 210 mm)	\$ 140.00	10	50
TP1184	7/8 x 11 (22 x 260 mm)	\$ 150.00	10	50
TP1185	7/8 x 18 (22 x 460 mm)	\$ 220.00	5	25
TP1186	1 x 10 (25 x 260 mm)	\$ 210.00	5	25
TP1187	1 x 18 (25 x 460 mm)	\$ 265.00	5	25

CÓDIGO	DESCRIPCIÓN	PRECIO	INNER	MASTER
TP1188	1/4 x 4 (6 x 110 mm)	\$ 29.00	10	200
TP1189	1/4 x 6 (6 x 160 mm)	\$ 30.00	10	200
TP1190	1/4 x 8 (6 x 210 mm)	\$ 40.00	10	200
TP1191	1/4 x 10 (6 x 260 mm)	\$ 46.00	10	200
TP1192	5/16 x 6 (8 x 160 mm)	\$ 36.00	10	200
TP1193	5/16 x 12 (8 x 310 mm)	\$ 59.00	5	100
TP1194	3/8 x 6 (10 x 160 mm)	\$ 47.00	10	200
TP1195	3/8 x 12 (10 x 310 mm)	\$ 64.00	5	100
TP1196	3/8 x 18 (10 x 460 mm)	\$ 85.00	5	100
TP1197	7/16 x 6 (12 x 160 mm)	\$ 51.00	10	200
TP1198	7/16 x 12 (12 x 310 mm)	\$ 72.00	5	100
TP1199	1/2 x 6 (13 x 160 mm)	\$ 68.00	10	200
TP1200	1/2 x 12 (13 x 310 mm)	\$ 91.00	5	100
TP1201	1/2 x 18 (13 x 460 mm)	\$ 125.00	5	100
TP1202	9/16 x 6 (14 x 160 mm)	\$ 75.00	10	100
TP1203	9/16 x 12 (14 x 310 mm)	\$ 98.00	5	100
TP1204	5/8 x 8 (16 x 210 mm)	\$ 112.00	10	100
TP1205	5/8 x 12 (16 x 310 mm)	\$ 130.00	5	50
TP1206	5/8 x 24 (16 x 600 mm)	\$ 205.00	2	25
TP1207	3/4 x 8 (18 x 210 mm)	\$ 158.00	10	50
TP1208	3/4 x 12 (18 x 310 mm)	\$ 184.00	5	50
TP1209	3/4 x 18 (18 x 460 mm)	\$ 204.00	5	25
TP1210	7/8 x 8 (22 x 210 mm)	\$ 191.00	10	50
TP1211	7/8 x 11 (22 x 260 mm)	\$ 215.00	10	50
TP1212	7/8 x 18 (22mm x 460 mm)	\$ 282.00	5	25
TP1213	1 x 10 (25 x 260 mm)	\$ 260.00	5	25
TP1214	1 x 18 (25 x 460 mm)	\$ 336.00	5	25

El aspecto, empaque, inner o master de los productos puede variar sin previo aviso debido a la innovación continua de nuestras marcas.



## Broca de alta velocidad para metal 10 piezas

Producto **NUEVO**



CÓDIGO	DESCRIPCIÓN	PIEZA	PAQUETE	INN.	MAS.
TPDB10116	1/16" x 1 3/4"	\$ 8.00	\$ 80.00	12	120
TPDB10564	5/64" x 2"	\$ 8.00	\$ 80.00	12	120
TPDB10332	3/32" x 2 1/4"	\$ 8.00	\$ 80.00	12	120
TPDB10764	7/64" x 2 5/8"	\$ 7.00	\$ 70.00	12	120
TPDB1018	1/8" x 2 3/4"	\$ 8.00	\$ 80.00	12	120
TPDB10964	9/64" x 3"	\$ 9.50	\$ 95.00	12	120
TPDB10532	5/32" x 3 1/8"	\$ 10.50	\$ 105.00	12	120
TPDB101164	11/64" x 3 1/4"	\$ 14.00	\$ 140.00	12	120

CÓDIGO	DESCRIPCIÓN	PIEZA	PAQUETE	INN.	MAS.
TPDB10316	3/16" x 3 1/2"	\$ 14.00	\$ 140.00	12	120
TPDB101364	13/64" x 3 1/2"	\$ 18.00	\$ 180.00	12	120
TPDB10732	7/32" x 3 3/4"	\$ 19.00	\$ 190.00	12	120
TPDB101564	15/64" x 3 3/4"	\$ 21.00	\$ 210.00	12	120
TPDB1014	1/4" x 4"	\$ 25.50	\$ 255.00	12	120
TPDB101764	17/64" x 4 1/4"	\$ 28.00	\$ 280.00	12	120
TPDB10932	9/32" x 4 1/4"	\$ 29.00	\$ 290.00	12	120

## Broca de alta velocidad para metal 5 piezas



CÓDIGO	DESCRIPCIÓN	PIEZA	PAQUETE	INN.	MAS.
TPDB5516	5/16" x 4 1/2"	\$ 45.00	\$ 225.00	12	120
TPDB538	3/8" x 5"	\$ 62.00	\$ 310.00	12	120
TPDB5716	7/16" x 5 1/2"	\$ 98.00	\$ 490.00	12	120
TPDB512	1/2" x 6"	\$ 92.00	\$ 460.00	12	120

## Broca para concreto 5 piezas

Puntas de carburo de tungsteno

Producto **NUEVO**



CÓDIGO	DESCRIPCIÓN	PIEZA	PAQUETE	INNER	MASTER
TPMDB51844	1/8" x 4"	\$ 7.00	\$ 35.00	12	120
TPMDB53164	3/16" x 4"	\$ 10.00	\$ 50.00	12	120
TPMDB53166	3/16" x 6"	\$ 13.00	\$ 65.00	12	120
TPMDB5144	1/4" x 4"	\$ 12.50	\$ 62.00	12	120
TPMDB5146	1/4" x 6"	\$ 13.00	\$ 65.00	12	120
TPMDB55164	5/16" x 4"	\$ 14.00	\$ 79.00	12	120
TPMDB55166	5/16" x 6"	\$ 16.00	\$ 95.00	12	120
TPMDB5384	3/8" x 4"	\$ 26.00	\$ 131.00	12	120
TPMDB5386	3/8" x 6"	\$ 28.00	\$ 139.00	12	120
TPMDB5126	1/2" x 6"	\$ 42.50	\$ 212.00	12	120
TPMDB51412	1/4" x 12"	\$ 25.00	\$ 125.00	12	120
TPMDB551612	5/16" x 12"	\$ 33.50	\$ 167.00	12	120
TPMDB53812	3/8" x 12"	\$ 40.50	\$ 202.00	12	120
TPMDB51212	1/2" x 12"	\$ 50.00	\$ 250.00	12	120

## Juego de 4 brocas para concreto

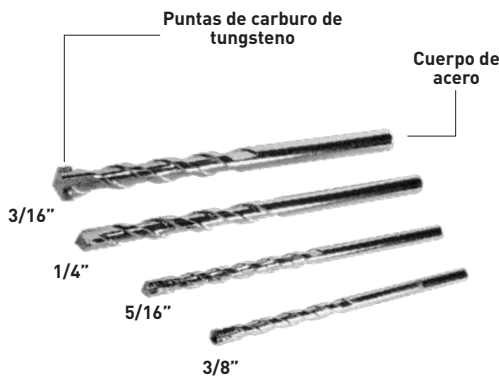

CÓDIGO	PRECIO	INNER	MASTER
TPMDB4P	\$ 58.00	12	144

## Juego de brocas para metal de acero HSS



TPDB7H



TPDB13H



7 PIEZAS		13 PIEZAS		
1/16", 5/64", 3/32", 7/64", 1/8", 3/16" y 1/4"		1/4", 15/64", 7/32", 13/64", 3/16", 11/64", 5/32", 9/64", 1/8", 7/64", 3/32", 5/64" y 1/16"		
CÓDIGO	DESCRIPCIÓN	PRECIO	INNER	MASTER
TPDB7H	7 Piezas	\$ 65.00	25	100
TPDB13H	13 Piezas	\$ 160.00	25	100

El aspecto, empaque, inner o master de los productos puede variar sin previo aviso debido a la innovación continua de nuestras marcas.

**Desarmador punta cruz**



**Desarmador punta plana**

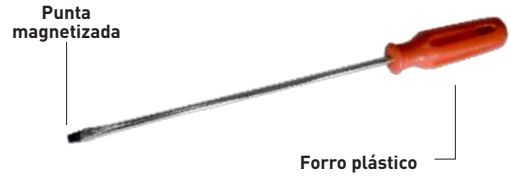

CÓDIGO	DESCRIPCIÓN	PRECIO	INNER	MASTER
TPD144	3/16" x 3" (4.76 x 76.2 mm)	\$ 21.00	12	144
TPD145	3/16" x 6" (4.76 x 152.4 mm)	\$ 23.00	12	144
TPD146	3/16" x 8" (4.76 x 203.2 mm)	\$ 25.00	12	144
TPD147	1/4" x 4" (6.35 x 101.6 mm)	\$ 24.00	12	144
TPD148	1/4" x 6" (6.35 x 152.4 mm)	\$ 26.00	12	144
TPD149	1/4" x 8" (6.35 x 203.2 mm)	\$ 32.00	12	144

CÓDIGO	DESCRIPCIÓN	PRECIO	INN.	MAS.
TPD136	1/8" x 4" (3.17 x 101.6 mm)	\$ 15.00	12	144
TPD137	1/8" x 6" (3.17 x 154.4 mm)	\$ 16.00	12	144
TPD138	1/8" x 8" (3.17 x 203.2 mm)	\$ 18.00	12	144
TPD139	3/16" x 4" (4.76 x 101.6 mm)	\$ 22.00	12	144
TPD140	3/16" x 6" (4.76 x 152.4 mm)	\$ 24.00	12	144
TPD141	3/16" x 8" (4.76 x 203.2 mm)	\$ 28.00	12	144
TPD142	1/4" x 4" (6.35 x 101.6 mm)	\$ 27.00	12	144
TPD143	1/4" x 6" (6.35 x 152.4 mm)	\$ 27.00	12	144

**Desarmador punta cruz**



**Desarmador punta plana**



CÓDIGO	DESCRIPCIÓN	PRECIO	INNER	MASTER
TPD122	1/8" x 3"	\$ 21.00	12	96
TPD123	1/8" x 4"	\$ 22.00	12	96
TPD124	1/8" x 6"	\$ 23.00	12	96
TPD125	1/8" x 8"	\$ 25.00	12	96
TPD126	3/16" x 3"	\$ 25.00	12	96
TPD127	3/16" x 4"	\$ 22.00	12	96
TPD128	3/16" x 6"	\$ 22.00	12	96
TPD129	3/16" x 8"	\$ 30.00	12	96
TPD130	1/4" x 1 1/2"	\$ 21.00	12	96
TPD131	1/4" x 4"	\$ 28.00	12	96
TPD132	1/4" x 6"	\$ 28.00	12	96
TPD133	1/4" x 8"	\$ 33.00	12	96
TPD134	5/16" x 6"	\$ 48.00	12	96
TPD135	3/8" x 8"	\$ 55.00	12	96

CÓDIGO	DESCRIPCIÓN	PRECIO	INNER	MASTER
TPD109	1/8" x 3"	\$ 22.00	12	96
TPD110	1/8" x 4"	\$ 21.00	12	96
TPD111	1/8" x 6"	\$ 20.00	12	96
TPD112	1/8" x 8"	\$ 25.00	12	96
TPD113	3/16" x 3"	\$ 28.00	12	96
TPD114	3/16" x 4"	\$ 22.00	12	96
TPD115	3/16" x 6"	\$ 22.00	12	96
TPD116	3/16" x 8"	\$ 37.00	12	96
TPD117	1/4" x 1 1/2"	\$ 22.00	12	96
TPD118	1/4" x 4"	\$ 30.00	12	96
TPD119	1/4" x 6"	\$ 30.00	12	96
TPD120	5/16" x 6"	\$ 48.00	12	96
TPD121	3/8" x 8"	\$ 55.00	12	96

**Desarmador de golpe punta cruz**



**Desarmador de golpe punta plana**



CÓDIGO	DESC.	PRECIO	INNER	MASTER
TPDG494	3/16" x 3"	\$ 38.00	12	96
TPDG495	1/4" x 4"	\$ 45.00	12	96
TPDG496	1/4" x 6"	\$ 48.00	12	96
TPDG497	5/16" x 8"	\$ 70.00	12	48

CÓDIGO	DESC.	PRECIO	INNER	MASTER
TPDG498	3/16" x 3"	\$ 38.00	12	96
TPDG499	1/4" x 4"	\$ 43.00	12	96
TPDG500	1/4" x 6"	\$ 48.00	12	96
TPDG501	5/16" x 8"	\$ 72.00	12	48

# DESARMADORES



DESARMADORES

## Juego de desarmadores

TPDJ151



CÓDIGO	DESC.	PRECIO	INNER	MASTER
TPDJ150	4 Pzas	\$ 96.00	12	48
TPDJ151	6 Pzas	\$ 155.00	6	24

## Juego de desarmador de golpe heavy duty (uso rudo) 6 piezas



CÓDIGO	PRECIO	INNER	MASTER
TPDJ152	\$ 170.00	6	24

## Desarmador trompo con matraca 6 puntas

Caja display con 12 piezas

6 puntas dobles



CÓDIGO	PRECIO	INNER	MASTER
TPDT490	\$ 80.00	12	48

## Juego desarmador con puntas 6 en 1

2 Puntas planas 3/16" y 1/4"

2 Puntas cruz #1 y #2

2 Puntas estrella SD-15 y SD-20



CÓDIGO	PRECIO	INNER	MASTER
TPDJ6	\$ 46.00	72	144

## Juego desarmador tipo matraca



3 Posiciones

Puntas de acero cromo vanadio



CÓDIGO	PRECIO	INNER	MASTER
TPD358	\$ 188.00	6	36

## Desarmador joyero

14 Puntas

Barra con punta magnética

Puntas de acero cromo vanadio



- ⊖ 3 Pzas
- ⊕ 4 Pzas
- ⊗ 3 Pzas
- 2 Pzas
- ▲ 1 Pza
- ⊖ 1 Pza

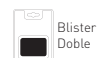

CÓDIGO	PRECIO	INNER	MASTER
TPD359	\$ 118.00	6	36

## Juego desarmador con puntas y dados 34 piezas

Puntas y dados de acero cromo vanadio



CONTIENE			
3 Puntas planas 3/16", 1/4", 9/32"			
7 Puntas cruz #1, #2 x 5 Piezas, #3			
2 Puntas hexagonales 1/8", 3/16"			
3 Puntas torx T-15, T-20, T-25			
6 Dados estandar 1/4", 5/16", 11/32", 3/8", 7/16", 1/2"			
6 Dados milimétricos 5, 6, 7, 8, 9, 10 mm			
1 Adaptador 1/4"			
1 Desarmador reversible			

CÓDIGO	PRECIO	INNER	MASTER
TPDJ34	\$ 135.00	6	24

## Juego desarmador con puntas y dados 53 piezas

Puntas y dados de acero cromo vanadio



CONTIENE			
Puntas planas 5/32" 3/16", 1/4", 9/32"			
Puntas cruz #0, #1, #2 x 7 Piezas, #3			
Puntas hexagonales 1/8", 5/32" 3/16" 7/32", 1/4"			
Puntas torx T-10, T-15, T-20, T-25 T-27, T-30, T-40, T-45			
Dados: 3/16", 7/32", 1/4", 5/16", 11/32", 3/8", 15/32", 7/16", 1/2"			
Punta cuadrada: S1, S2, S3			
1 Adaptador 1/4"			
1 Desarmador reversible			

CÓDIGO	PRECIO	INNER	MASTER
TPDJ53	\$ 167.00	6	24

## Juego desarmador con puntas y dados 36 piezas

Puntas y dados de acero cromo vanadio



CANT.	TIPO.	DESCRIPCIÓN
5	⊖	3 mm 4 mm 5 mm 6 mm 7 mm
4	⊕	# 0 # 1 # 2 # 3
4	⊗	PZ0 PZ1 PZ2 PZ3
7	⊗	T10 T15 T20 T25 T27 T30 T40
4	●	# 2 # 3 # 4 # 5
9	⌵	4 mm 5 mm 6 mm 7 mm 8 mm 9 mm 10 mm 11 mm 12 mm
1		Adaptador
1		Extensión
1		Desarmador tipo matraca

CÓDIGO	PRECIO	INNER	MASTER
TPDPD491	\$ 185.00	12	24

El aspecto, empaque, inner o master de los productos puede variar sin previo aviso debido a la innovación continua de nuestras marcas.

**Cabeza hacha tipo español media labor**

Acero con doble tratamiento térmico 1045



CÓDIGO	DESC.	PRECIO	INNER	MASTER
TPH392	3 lbs	\$ 170.00	6	12
TPH393	3 1/2 lbs	\$ 190.00	6	12
TPH394	4 lbs	\$ 210.00	6	12
TPH395	4 1/2 lbs	\$ 225.00	6	12

**Hacha cazadora 1 1/2 lbs**

Largo: 34 cm



Mango de fibra de vidrio

Acero con doble tratamiento térmico 1045



CÓDIGO	PRECIO	INNER	MASTER
TPH112FV	\$ 155.00	6	24

**Cabeza talacho / hacha 5 lbs**

Acero con doble tratamiento térmico 1045



Dureza 47 HRC



CÓDIGO	PRECIO	INNER	MASTER
TPTH387	\$ 180.00	1	6

**Talacho / hacha con mango 5 lbs**

Largo: 91 cm



Acero con doble tratamiento térmico 1045

Madera de encino

Dureza 47 HRC



CÓDIGO	PRECIO	INNER
TPTM434	\$ 275.00	1

**Mango para hacha de madera de encino**

Largo: 91 cm



CÓDIGO	PRECIO	INNER	MASTER
TPMH436	\$ 98.00	1	10

**Hacha cazadora 1 1/2 lbs**

Largo: 33.5 cm



Acero con doble tratamiento térmico 1045



CÓDIGO	PRECIO	INNER	MASTER
TPH400	\$ 158.00	1	24

**Cabeza zapapico 5 lbs**

Acero con doble tratamiento térmico 1045



Dureza 47 HRC



CÓDIGO	PRECIO	INNER	MASTER
TPZ386	\$ 180.00	1	6

**Zapapico con mango 5 lbs**

Largo: 91 cm



Acero con doble tratamiento térmico 1045

Madera de encino

Dureza 47 HRC



CÓDIGO	PRECIO	INNER
TPZM433	\$ 275.00	1

**Hacha tipo español con mango media labor**

Largo: 91 cm

Acero con doble tratamiento térmico 1045



CÓDIGO	DESC.	PRECIO	INNER
TPH437	3 lbs	\$ 268.00	1
TPH438	3 1/2 lbs	\$ 288.00	1
TPH439	4 lbs	\$ 308.00	1
TPH440	4 1/2 lbs	\$ 323.00	1

**Cabeza talacho / pico 5 lbs**

Acero con doble tratamiento térmico 1045



Dureza 47 HRC



CÓDIGO	PRECIO	INNER	MASTER
TPTP787	\$ 180.00	1	6

**Talacho / pico con mango 5 lbs**

Largo: 91 cm



Acero con doble tratamiento térmico 1045

Madera de encino

Dureza 47 HRC



CÓDIGO	PRECIO	INNER
TPTM979	\$ 275.00	1

**Mango zapapico / talacho de madera de encino**

Largo: 91 cm



CÓDIGO	PRECIO	INNER	MASTER
TPM435	\$ 95.00	1	10

El aspecto, empaque, inner o master de los productos puede variar sin previo aviso debido a la innovación continua de nuestras marcas.



### Mango para bieldo



Madera de pino

CÓDIGO	DESCRIPCIÓN	PRECIO	INN.	MAS.
TPMB1938	48" (122 cm)	\$ 125.00	1	10
TPMB1937	54" (137 cm)	\$ 145.00	1	10

### Mango para cavahoyos

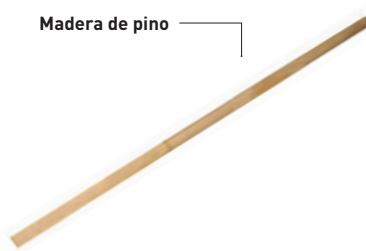

Madera de pino

CÓDIGO	DESCRIPCIÓN	PRECIO	INN.	MAS.
TPMC1939	48" (122 cm)	\$ 135.00	1	10

### Mango para guadaña

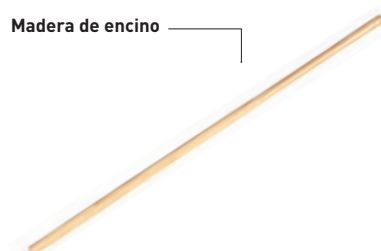

Madera de encino

CÓDIGO	DESCRIPCIÓN	PRECIO	INN.	MAS.
TPMG1940	48" (122 cm)	\$ 182.00	1	10

### Mango para rastrillo

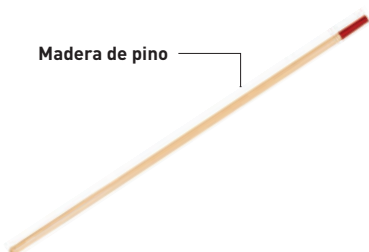

Madera de pino

CÓDIGO	DESCRIPCIÓN	PRECIO	INN.	MAS.
TPMR1955	48" (122 cm)	\$ 105.00	1	10
TPMR1954	54" (137 cm)	\$ 120.00	1	10

### Mango para pala azada

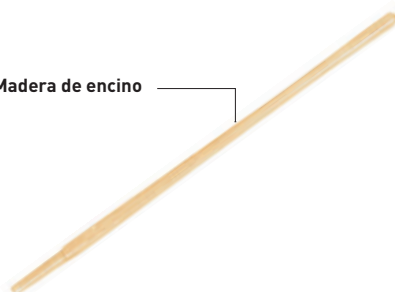

Madera de encino

CÓDIGO	DESCRIPCIÓN	PRECIO	INN.	MAS.
TPMM1952	48" (122 cm)	\$ 125.00	1	10

### Mango para pala puño "Y"



Madera de encino

CÓDIGO	DESCRIPCIÓN	PRECIO	INN.	MAS.
TPMP1953	24" (61 cm)	\$ 135.00	1	10

### Mango para martillo de uña



Madera de encino

CÓDIGO	DESCRIPCIÓN	PRECIO	INN.	MAS.
TPMM1949	12" (30 cm)	\$ 36.00	1	10
TPMM1950	14" (35 cm)	\$ 48.00	1	10
TPMM1951	16" (40 cm)	\$ 56.00	1	10

### Mango para martillo de bola



Madera de encino

CÓDIGO	DESCRIPCIÓN	PRECIO	INN.	MAS.
TPMM1946	12" (30 cm)	\$ 45.00	1	10
TPMM1947	14" (35 cm)	\$ 47.00	1	10
TPMM1948	16" (40 cm)	\$ 51.00	1	10

### Mango para hacha Michigan



Madera de encino

CÓDIGO	DESC.	PRECIO	INN.	MAS.
TPMH1942	36" (91 cm)	\$ 105.00	1	10

### Mango para hacha curva



Madera de encino

CÓDIGO	DESCRIPCIÓN	PRECIO	INN.	MAS.
TPMH1941	36" (91 cm)	\$ 113.00	1	10

### Mango para marro



Madera de encino

CÓDIGO	DESCRIPCIÓN	PRECIO	INN.	MAS.
TPMM1944	26" (66 cm)	\$ 68.00	1	10
TPMM1943	30" (76 cm)	\$ 85.00	1	10

### Mango para marro/mazo



Madera de encino

CÓDIGO	DESCRIPCIÓN	PRECIO	INN.	MAS.
TPMM1945	10" (25 cm)	\$ 41.50	1	10

El aspecto, empaque, inner o master de los productos puede variar sin previo aviso debido a la innovación continua de nuestras marcas.



### Clavo estándar con cabeza Caja 20 kg



CÓDIGO	DESCRIPCIÓN	PRECIO POR KG	PRECIO POR CAJA
CSTD621	1.18 mm x 3/4"	\$ 50.00	\$ 1,000.00
CSTD622	1.82 mm x 1"	\$ 47.50	\$ 950.00
CSTD623	1.88 mm x 1 1/2"	\$ 47.50	\$ 950.00
CSTD624	2.46 mm x 2"	\$ 47.50	\$ 950.00
CSTD625	3.06 mm x 2 1/2"	\$ 47.50	\$ 950.00
CSTD626	3.88 mm x 3"	\$ 47.50	\$ 950.00
CSTD627	4.44 mm x 4"	\$ 47.50	\$ 950.00
CSTD628	4.86 mm x 5"	\$ 47.50	\$ 950.00
CSTD629	5.14 mm x 6"	\$ 49.95	\$ 1000.00

### Clavo para concreto Caja 20 kg



CÓDIGO	DESCRIPCIÓN	PRECIO POR KG	PRECIO POR CAJA
CC634	3.74 mm x 3/4"	\$ 62.00	\$ 1,240.00
CC635	3.88 mm x 1"	\$ 62.00	\$ 1,240.00
CC636	3.8 mm x 1 1/2"	\$ 62.00	\$ 1,240.00
CC637	3.8 mm x 2 1/2"	\$ 62.00	\$ 1,240.00
CC638	3.84 mm x 2"	\$ 62.00	\$ 1,240.00
CC639	3.78 mm x 3"	\$ 62.00	\$ 1,240.00
CC640	3.76 mm x 4"	\$ 62.00	\$ 1,240.00

### Clavo estándar sin cabeza Caja 20 kg



CÓDIGO	DESCRIPCIÓN	PRECIO POR KG	PRECIO POR CAJA
CSTD630	1.18 mm x 3/4"	\$ 50.00	\$ 1,000.00
CSTD631	1.38 mm x 1"	\$ 50.00	\$ 1,000.00
CSTD632	1.9 mm x 1 1/2"	\$ 50.00	\$ 1,000.00
CSTD633	2.88 mm x 2"	\$ 50.00	\$ 1,000.00

### Rollo alambre galvanizado 1 kg



CÓDIGO	DESCRIPCIÓN	PRECIO	INNER	MASTER
TPGW12	No. 12	\$ 56.00	1	20
TPGW14	No. 14	\$ 52.00	1	20
TPGW16	No. 16	\$ 54.00	1	20
TPGW18	No. 18	\$ 60.00	1	20
TPGW20	No. 20	\$ 65.00	1	20
TPGW22	No. 22	\$ 68.00	1	20

### Malla hexagonal 45 m de largo



Acero galvanizado



CÓDIGO	DESCRIPCIÓN	PRECIO	Peso
TPTHA1390	13 mm x 90 cm Cal. 0.5	\$ 1,620.00	15 kg
TPTHA25100	25 mm x 100 cm Cal. 0.9	\$ 1,300.00	14 kg
TPTHA25150	25 mm x 150 cm Cal. 1.5	\$ 1,710.00	23.3 kg
TPTHA2590	25 mm x 90 cm Cal. 0.9	\$ 1,480.00	14 kg
TPTHA50150	50 mm x 150 cm Cal.1.5	\$ 1,300.00	13.4 kg

### Grapa para alambre galvanizado Caja 10 kg



CÓDIGO	DESCRIPCIÓN	PRECIO POR KG	PRECIO POR CAJA
TPGP954	1"	\$ 49.00	\$ 490.00
TPGP955	1 1/4"	\$ 49.00	\$ 490.00

### Malla mosquitera 30 m de largo

Calibre: 1.5 mm  
Espesor: 0.26 mm  
Previene la entrada de insectos  
Para cribar y colar

Acero galvanizado



CÓDIGO	DESCRIPCIÓN	PRECIO	Peso
TPTMA60	60 cm de ancho	\$ 1,140.00	10 kg
TPTMA75	75 cm de ancho	\$ 1,350.00	12.1 kg
TPTMA90	90 cm de ancho	\$ 1,680.00	15 kg
TPTMA105	105 cm de ancho	\$ 1,900.00	17 kg
TPTMA120	120 cm de ancho	\$ 2,200.00	19.5 kg

### Tela criba de acero 90 cm de ancho x 10 m largo



CÓDIGO	DESCRIPCIÓN	PRECIO	Peso
TPTCA22	2 Cuadros p/pulg. Cal. 0.9 mm	\$ 1,030.00	7.3 kg
TPTCA33	3 Cuadros p/pulg. Cal. 0.7 mm	\$ 1,040.00	6 kg
TPTCA44	4 Cuadros p/pulg. Cal. 0.55 mm	\$ 1,200.00	5.6 kg
TPTCA55	5 Cuadros p/pulg. Cal. 0.55 mm	\$ 1,500.00	6.8 kg
TPTCA66	6 Cuadros p/pulg. Cal. 0.45 mm	\$ 1,200.00	5.6 kg
TPTCA88	8 Cuadros p/pulg. Cal. 0.40 mm	\$ 1,350.00	5.6 kg

### Tela mosquitera de fibra de vidrio 30 m de largo

Espesor: 0.28 mm



Autoextinguible



CÓDIGO	DESCRIPCIÓN	PRECIO	Peso
TPTM1675	90 cm de ancho	\$ 600.00	3 kg
TPTM1676	120 cm de ancho	\$ 780.00	4 kg

**Llave ajustable**



CÓDIGO	DESC.	PRECIO	INNER	MASTER
TPL154	6"	\$ 75.00	12	120
TPL155	8"	\$ 90.00	12	96
TPL156	10"	\$ 125.00	12	48
TPL157	12"	\$ 185.00	12	36

**Llave stillson**

Uso rudo



CÓDIGO	DESC.	PRECIO	INNER	MASTER
TPPW8MHD	8"	\$ 97.00	1	36
TPPW10MHD	10"	\$ 136.00	1	24
TPPW12MHD	12"	\$ 150.00	1	18
TPPW14MHD	14"	\$ 190.00	1	18
TPPW18MHD	18"	\$ 300.00	1	12
TPPW24MHD	24"	\$ 365.00	4	12

**Pinza de presión mordaza recta**



CÓDIGO	DESC.	PRECIO	INNER	MASTER
TPLGP5S	5"	\$ 85.00	12	96
TPLGP7S	7"	\$ 100.00	12	48
TPLGP10S	10"	\$ 110.00	6	36

**Machete estándar**



CÓDIGO	DESC.	PRECIO	INNER	MASTER
TPMM1093	14"	\$ 67.00	24	48
TPMM1094	16"	\$ 69.00	24	48
TPMM1095	18"	\$ 70.00	24	48
TPMM1096	20"	\$ 72.00	24	48
TPMM1097	22"	\$ 74.00	24	48
TPMM1098	24"	\$ 75.00	24	48

**Llave para gas 7/8"**



CÓDIGO	PRECIO	INNER	MASTER
TPLG1045	\$ 58.00	10	60

**Llave para plomero**



CÓDIGO	DESCRIPCIÓN	PRECIO	INNER	MASTER
TPBW11	11" (27.9 mm)	\$ 160.00	6	36
TPBW16	16" (40.6 mm)	\$ 182.00	6	36

**Tijera tipo aviación 10"**

Hojas de acero



CÓDIGO	DESCRIPCIÓN	PRECIO	INNER	MASTER
TPATSL	Corte izquierdo	\$ 165.00	12	48
TPATSR	Corte derecho	\$ 165.00	12	48
TPATS	Corte recto	\$ 165.00	12	48

**Tijera multusos**



CÓDIGO	DESC.	PRECIO	INNER	MASTER
TPT389	6"	\$ 37.00	12	120
TPT390	7"	\$ 40.00	12	120
TPT391	8"	\$ 44.00	12	120

**Tijera para hojalatero**



CÓDIGO	DESC.	PRECIO	INNER	MASTER
TPTMS8	8"	\$ 140.00	12	72
TPTMS10	10"	\$ 175.00	8	48
TPTMS12	12"	\$ 200.00	12	36

## Juego de pinzas para chofer

Fabricadas en acero al carbono  
Medidas: 6, 8, 10"



Etiqueta

CÓDIGO	PRECIO	INNER	MASTER
TPJPCH3	\$ 189.00	1	5

## Pinzas para chofer

Fabricadas en acero al carbono



Blister

CÓDIGO	DESC.	PRECIO	INNER	MASTER
TPPCH6	6"	\$ 50.00	12	120
TPPCH8	8"	\$ 68.00	12	60

## Pinza para electricista

Fabricadas en acero al carbono



Blister Doble

CÓDIGO	DESC.	PRECIO	INNER	MAS.
TPP1144	6"	\$ 75.00	12	48
TPP162	7"	\$ 83.00	12	48
TPP163	8"	\$ 88.00	12	48
TPP164	Profesional 8"	\$ 132.00	12	48
TPP165	Profesional 9"	\$ 152.00	12	48

## Pinza de extensión 10"

Fabricadas en acero al carbono

Mango de vinil alto desempeño



6 Posiciones



Blister Doble

CÓDIGO	PRECIO	INNER	MASTER
TPPE10	\$ 150.00	6	36

## Pinza de corte diagonal

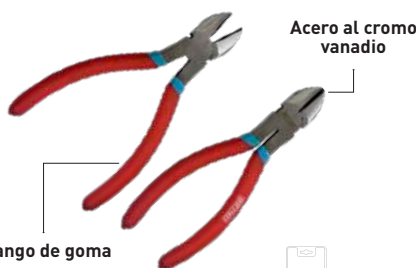

Mango de goma



Blister Doble

CÓDIGO	DESC.	PRECIO	INNER	MASTER
TPP158	6"	\$ 69.00	12	48
TPP159	8"	\$ 85.00	12	48

## Pinza de punta y corte

Acero al cromo vanadio

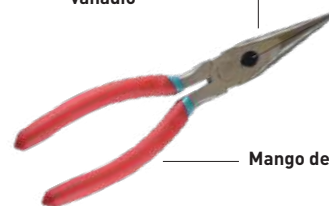

Mango de goma



Blister Doble

CÓDIGO	DESC.	PRECIO	INNER	MASTER
TPP160	6"	\$ 68.00	12	48
TPP161	8"	\$ 86.00	12	48

## Pinza multiusos acero inoxidable 15 funciones

Pinzas punta larga

Destapador

Desarmador

Navaja

Saca-anzuelo

Regla graduada

Abrelatas

Lima de uñas

Navaja chica

Sierra

Mordaza curva

Cizalla para corte



Descamador

2 Desarmadores planos

Desarmador de cruz



Blister Doble

CÓDIGO	PRECIO	INNER	MASTER
TPPM470	\$ 240.00	12	24

## Juego de 3 pinzas 6"

Fabricadas en acero al carbono

Incluye: electricista, corte diagonal, punta y corte, chofer de 6"



Blister Doble

CÓDIGO	PRECIO	INNER	MASTER
TPJP166	\$ 190.00	6	12

## Juego de 4 pinzas 8"

Fabricadas en acero al carbono

Incluye: electricista, corte diagonal, punta y corte, chofer de 8"



Blister Doble

CÓDIGO	PRECIO	INNER	MASTER
TPJP167	\$ 390.00	1	12

## Cuchilla repuesto para cortaperno

Uso rudo



Forjado en acero cromo-molibdeno



Etiqueta

CÓDIGO	DESC.	PRECIO	INNER	MASTER
TPCUT14	14"	\$ 120.00	1	30
TPCUT18	18"	\$ 160.00	1	30
TPCUT24	24"	\$ 190.00	1	30
TPCUT30	30"	\$ 250.00	1	10
TPCUT36	36"	\$ 320.00	1	10

## Pinza cortaperno

Uso rudo



Mordaza forjada de acero cromo-vanadio



Caja a color

CÓDIGO	DESC.	PRECIO	INNER	MASTER
TPBC18HD	18"	\$ 300.00	1	10
TPBC24HD	24"	\$ 430.00	1	6
TPBC30HD	30"	\$ 600.00	1	4
TPBC36HD	36"	\$ 730.00	1	3

## Pinza pelacable

Corta cables de 10 a 24 AWG



Con tope para pelar el cable deseado

Ajuste de presión de las mordazas

Quita el aislante de forma automática



Blister Doble

CÓDIGO	PRECIO	INNER	MASTER
TPPP1139	\$ 85.00	24	48

**Llave española estándar**

Cuerpo de acero al carbono



Etiqueta

CÓDIGO	DESCRIPCIÓN	PRECIO	INN.	MAS.
TPE14516E	1/4" x 5/16"	\$ 17.00	10	50
TPE71612E	7/16" x 1/2"	\$ 18.00	10	50
TPE12916E	1/2" x 9/16"	\$ 20.00	10	50
TPE5834E	5/8" x 3/4"	\$ 29.00	5	50

**Llave española milimétrica**

Cuerpo de acero al carbono



Etiqueta

CÓDIGO	DESCRIPCIÓN	PRECIO	INNER	MASTER
TPE89M	8 x 9 mm	\$ 15.00	10	50
TPE1011M	10 x 11 mm	\$ 17.00	10	50
TPE1213M	12 x 13 mm	\$ 19.00	10	50
TPE1415M	14 x 15 mm	\$ 20.00	5	50
TPE1617M	16 x 17 mm	\$ 23.00	5	50
TPE1819M	18 x 19 mm	\$ 28.00	5	50

**Juego de llaves combinadas 11 piezas milimétricas**

Medidas: 6, 7, 8, 9, 10, 11, 12, 13, 14, 17 y 19 mm

Cuerpo de acero al carbono



Estuche Etiqueta

CÓDIGO	PRECIO	INNER	MASTER
TPJLC11M	\$ 270.00	1	12

**Juego de llaves combinadas 5 piezas estándar**

Medidas: 3/8, 7/16, 1/2, 9/16 y 5/8"

Cuerpo de acero al carbono



Etiqueta

CÓDIGO	PRECIO	INNER	MASTER
TPJLC5E	\$ 65.00	1	12

**Juego de llaves combinadas 5 piezas milimétricas**

Medidas: 8, 10, 12, 14, y 17 mm

Cuerpo de acero al carbono



Etiqueta

CÓDIGO	PRECIO	INNER	MASTER
TPJLC5M	\$ 65.00	1	12

**Juego de llaves combinadas 11 piezas**

Medidas: 1/4", 5/16", 3/8", 7/16", 1/2", 9/16", 5/8", 11/16", 3/4", 13/16" y 7/8"

Cuerpo de acero al carbono



Estuche Etiqueta

CÓDIGO	PRECIO	INNER	MASTER
TPJLC11E	\$ 360.00	1	12

**Llave combinada estándar**



Cuerpo de acero al carbono



Etiqueta

CÓDIGO	DESC.	PRECIO	INNER	MASTER
TPLLC14E	1/4"	\$ 20.00	10	50
TPLLC516E	5/16"	\$ 21.00	10	50
TPLLC38E	3/8"	\$ 25.00	10	50
TPLLC716E	7/16"	\$ 25.00	10	50
TPLLC12E	1/2"	\$ 26.00	10	50
TPLLC916E	9/16"	\$ 32.00	5	50
TPLLC58E	5/8"	\$ 31.00	5	50
TPLLC1116E	11/16"	\$ 35.00	5	50
TPLLC34E	3/4"	\$ 45.00	5	10
TPLLC1316E	13/16"	\$ 58.00	5	20
TPLLC78E	7/8"	\$ 66.00	5	50
TPLLC1E	1"	\$ 85.00	5	10

**Llave combinada milimétrica**



Cuerpo de acero al carbono



Etiqueta

CÓDIGO	DESC.	PRECIO	INNER	MASTER
TPLLC10M	10 mm	\$ 22.00	10	50
TPLLC11M	11 mm	\$ 26.00	10	50
TPLLC12M	12 mm	\$ 28.00	10	50
TPLLC13M	13 mm	\$ 28.00	5	50
TPLLC14M	14 mm	\$ 31.00	5	50
TPLLC15M	15 mm	\$ 35.00	5	50
TPLLC17M	17 mm	\$ 40.00	5	10
TPLLC19M	19 mm	\$ 45.00	5	10

**Juego de llaves combinadas 22 piezas estándar / milimétricas**

Medidas: 6 a 19 mm y 1/4" a 3/4" estándar  
Cuerpo de acero al carbono



Estuche Etiqueta

CÓDIGO	PRECIO	INNER	MASTER
TPJLC22EM	\$ 504.00	1	8

El aspecto, empaque, inner o master de los productos puede variar sin previo aviso debido a la innovación continua de nuestras marcas.

### Juego de remachadora 10"

1 Llave

Con 4 boquillas intercambiables 3/32", 1/8", 5/32" y 3/16"

60 Remaches 3/32", 1/8", 5/32" y 3/16"



### Juego de remachadora 10"

1 Llave

Con 4 boquillas intercambiables 3/32", 1/8", 5/32" y 3/16"

60 Remaches 3/32", 1/8", 5/32" y 3/16"



### Remachadora profesional 10"



Cuerpo de aluminio



CÓDIGO	PRECIO	INNER	MASTER
TPHRK60	\$ 170.00	6	24

CÓDIGO	PRECIO	INNER	MASTER
TPHR2K60	\$ 180.00	6	24

CÓDIGO	PRECIO	INNER	MASTER
TPRS332	\$ 170.00	6	24

### Pistola eléctrica para silicón

Incluye 2 barras de silicón

Sellados, reparaciones, pasatiempos, carpintería y artesanías

127 V ~  
60 Hz



CÓDIGO	DESC.	PRECIO	INNER	MASTER
TPPS1219	15 Watts	\$ 93.00	6	36
TPPS1220	25 Watts	\$ 150.00	6	36

### Remache de aluminio

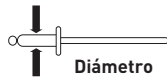

Diámetro



Ala ancha\*



CÓDIGO	DESCRIPCIÓN	PRECIO	INNER	MASTER
TPR1818	1/8" x 1/8" 100 pzas	\$ 25.00	10	80
TPR18316	1/8" x 3/16" 100 pzas	\$ 25.00	10	80
TPR1814	1/8" x 1/4" 100 pzas	\$ 25.00	10	80
TPR18516	1/8" x 5/16" 100 pzas	\$ 25.00	10	80
TPR1838	1/8" x 3/8" 100 pzas	\$ 25.00	10	80
TPR1812	1/8" x 1/2" 100 pzas	\$ 27.00	10	80
TPR53218	5/32" x 1/8" 100 pzas	\$ 30.00	10	80
TPR53214	5/32" x 1/4" 100 pzas	\$ 30.00	10	80
TPR53238	5/32" x 3/8" 100 pzas	\$ 30.00	10	80
TPR53212	5/32" x 1/2" 100 pzas	\$ 33.00	10	80
TPR31618	3/16" x 1/8" 100 pzas	\$ 38.00	10	80
TPR31614	3/16" x 1/4" 100 pzas	\$ 38.00	10	80
TPR31638	3/16" x 3/8" 100 pzas	\$ 50.00	10	80
TPR31612	3/16" x 1/2" 50 pzas	\$ 50.00	10	80
TPR31658	3/16" x 5/8" 50 pzas	\$ 25.00	15	120
TPR31634	3/16" x 3/4" 50 pzas	\$ 28.00	15	120
TPR31638LF*	3/16" x 3/8" 50 pzas	\$ 29.00	15	120
TPR31612LF*	3/16" x 1/2" 50 pzas	\$ 30.00	15	120
TPR1414	1/4" x 1/4" 50 pzas	\$ 38.00	15	120
TPR1438	1/4" x 3/8" 50 pzas	\$ 40.00	15	120
TPR31614LF*	3/16" x 1/4" 50 pzas	\$ 40.00	15	120
TPR31634LF*	3/16" x 3/4" 50 pzas	\$ 35.00	15	120
TPR1412	1/4" x 1/2" 50 pzas	\$ 43.00	15	120

### Barras de silicón 12 piezas

Sellados, reparaciones, pasatiempos, carpintería y artesanías



CÓDIGO	DESC.	PRECIO	INNER	MASTER
TPBS1221	5/16"	\$ 30.00	6	72
TPBS1222	1/2"	\$ 54.00	6	60

### Pistola calafateadora 9"

Varilla metálica dentada



Cuerpo de aluminio



### Pistola calafateadora 9"

Tipo esqueleto

Varilla hexagonal

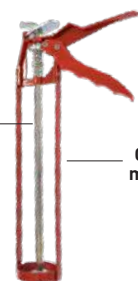

Cuerpo metálico



### Pistola calafateadora 9"

Tipo esqueleto Profesional

Muela de acero



Doble varilla



CÓDIGO	PRECIO	INNER	MASTER
TPCG	\$ 48.50	1	24

CÓDIGO	PRECIO	INNER	MASTER
TPCG1	\$ 60.00	1	24

CÓDIGO	PRECIO	INNER	MASTER
TPPS1133	\$ 155.00	6	12

**Pintura en aerosol**

283 gr

Secado rápido

Esmalte acrílico

Anti-corrosión



CÓDIGO	DESCRIPCIÓN	PRECIO	INNER	MASTER
TPPMA827	Rojo	\$ 43.00	1	12
TPPMA828	Verde	\$ 43.00	1	12
TPPMA829	Amarillo	\$ 43.00	1	12
TPPMA830	Naranja	\$ 43.00	1	12
TPPMA831	Negro mate	\$ 43.00	1	12
TPPMA832	Negro brillante	\$ 43.00	1	12
TPPMA833	Blanco brillante	\$ 43.00	1	12
TPPMA857	Blanco mate	\$ 43.00	1	12
TPPMA834	Transparente	\$ 43.00	1	12
TPPMA835	Azul cielo	\$ 43.00	1	12
TPPMA836	Azul rey	\$ 43.00	1	12
TPPMA837	Azul marino	\$ 43.00	1	12
TPPMA839	Café	\$ 43.00	1	12
TPPMA840	Gris	\$ 43.00	1	12
TPPMA841	Almendra	\$ 43.00	1	12
TPPMA842	Bronce	\$ 43.00	1	12
TPPMA856	Morado	\$ 43.00	1	12
TPPMA855	Rosa	\$ 43.00	1	12
TPPMA1354	Rosa pastel	\$ 56.00	1	12

**Pintura en aerosol fluorescente**

283 gr

Secado rápido

Esmalte acrílico

Anti-corrosión



CÓDIGO	DESCRIPCIÓN	PRECIO	INN.	MAS.
TPPMA846	Rojo	\$ 60.00	1	12
TPPMA847	Verde	\$ 60.00	1	12
TPPMA848	Azul	\$ 60.00	1	12
TPPMA849	Amarillo	\$ 60.00	1	12
TPPMA850	Naranja	\$ 60.00	1	12

**Pintura en aerosol metálicos**

283 gr

Secado rápido

Esmalte acrílico

Anti-corrosión



CÓDIGO	DESCRIPCIÓN	PRECIO	INN.	MAS.
TPPMA851	Cobre metálico	\$ 53.00	1	12
TPPMA852	Aluminio metálico	\$ 53.00	1	12
TPPMA853	Cromo metálico	\$ 63.00	1	12
TPPMA854	Oro brillante m.	\$ 63.00	1	12
TPPMA838	Oro mate	\$ 48.00	1	12

**Pintura en aerosol alta temperatura**

Resistente hasta 500 °C (932 °F)

283 gr

Secado rápido

Esmalte acrílico

Anti-corrosión



CÓDIGO	DESCRIPCIÓN	PRECIO	INN.	MAS.
TPPMA844	Negro	\$ 84.00	1	12
TPPMA845	Blanco	\$ 84.00	1	12
TPPMA843	Aluminio	\$ 84.00	1	12



### Brocha

Resistente a solventes  
Remaches niquelados  
Corte recto  
Uso doméstico

Mango de polipropileno



CÓDIGO	DESCRIPCIÓN	PRECIO	INN.	MAS.
TPB12	1/2" (12.7 mm)	\$ 6.00	12	144
TPB1	1" (25.4 mm)	\$ 8.00	12	144
TPB112	1 1/2" (38.1 mm)	\$ 10.00	12	144
TPB2	2" (50.8 mm)	\$ 13.00	12	72
TPB212	2 1/2" (63.5 mm)	\$ 15.00	12	72
TPB3	3" (76.2 mm)	\$ 18.00	12	72
TPB4	4" (101.6 mm)	\$ 31.00	12	48
TPB5	5" (127 mm)	\$ 36.00	12	48
TPB6	6" (152.4 mm)	\$ 45.00	12	48

### Maneral para felpa con jaula profesional 9"

Uso profesional  
Reutilizable

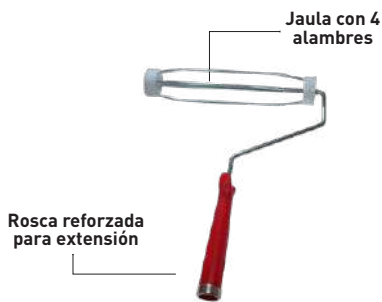

Rosca reforzada para extensión

Jaula con 4 alambres



CÓDIGO	PRECIO	INNER	MASTER
TPM9P	\$ 29.00	1	24

### Maneral para felpa sencillo 9"

Uso doméstico  
Reutilizable



Rosca reforzada para extensión

Maneral sin jaula



CÓDIGO	PRECIO	INNER	MASTER
TPM9E	\$ 18.00	1	24

### Charola para pintar 9"

Resistente a la intemperie  
Uso doméstico



CÓDIGO	PRECIO	INNER	MASTER
TPCHP	\$ 28.00	25	50

## TRUEPOWER PRO

### CHAROLA PARA PINTAR PROFESIONAL 9"

Resistente a la intemperie

Cuerpo de plástico

Producto NUEVO

300 g

CÓDIGO	PRECIO	INNER	MASTER
TP1063	\$ 38.00	1	35

### Extensión metálica para maneral



Rosca de plástico estándar



CÓDIGO	DESCRIPCIÓN	PRECIO	INN.	MAS.
TPM120	1.20 m	\$ 43.00	1	24
TPM240	1.20 m - 2.40 m	\$ 64.00	1	24
TPM3	1.50 m - 3.00 m	\$ 74.00	1	24

### Felpa para pintar poliéster termofundido

Para pintura vinílica y esmaltes  
Uso doméstico  
Reutilizable



CÓDIGO	DESCRIPCIÓN	PRECIO	INNER	MASTER
TPF38	3/8" x 9"	\$ 21.00	1	24
TPF34	3/4" x 9"	\$ 23.00	1	24
TPF1	1" x 9"	\$ 24.00	1	24
TPF114	1 1/4" x 9"	\$ 25.00	1	24

### Kit para pintar TRUEPOWER 3 piezas



1 TPF38 Felpa para pintar 3/8"



1 TPM9F Maneral para felpa sencillo 9"



1 TPCHP Charola para pintar 9"



CÓDIGO	PRECIO	INNER	MASTER
KIT8	\$ 67.00	1	20

### Kit para pintar TRUEPOWER 3 piezas



1 TPF38 Felpa para pintar 3/8"



1 TPM9F Maneral para felpa sencillo 9"



1 TP1063 Charola para pintar profesional 9"



CÓDIGO	PRECIO	INNER	MASTER
KIT36	\$ 80.00	1	20

**Escaleras de tijera**  
Aluminio / Tipo III doméstico



CÓDIGO	ALTURA TOTAL	CAPACIDAD DE CARGA	PRECIO	INNER
TPETATP4	1.21 m (4 ft)	90 kg	\$ 800.00	1
TPETATP5	1.51 m (5 ft)		\$ 1,000.00	1
TPETATP6	1.82 m (6 ft)		\$ 1,140.00	1

**Escaleras de tijera**  
Aluminio / Tipo III comercial

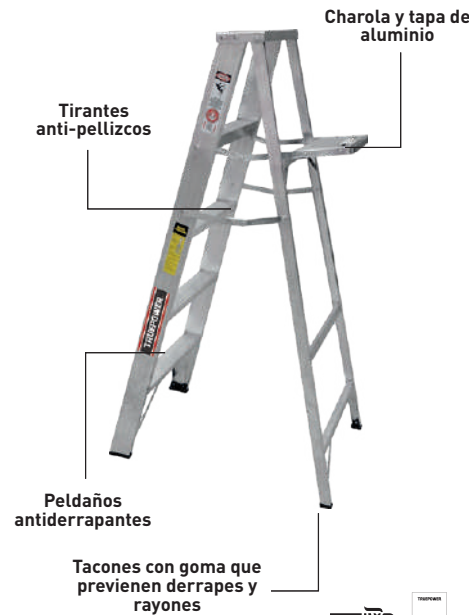

CÓDIGO	ALTURA TOTAL	CAPACIDAD DE CARGA	PRECIO	INNER
TPETATM3	0.90 m (3 ft)	150 kg	\$ 960.00	1
TPETATM4	1.21 m (4 ft)		\$ 1,110.00	1
TPETATM5	1.51 m (5 ft)		\$ 1,160.00	1
TPETATM6	1.82 m (6 ft)		\$ 1,350.00	1
TPETATM7	2.12 m (7 ft)		\$ 1,590.00	1

**Escalera de tijera**  
Fibra de vidrio / Tipo III comercial

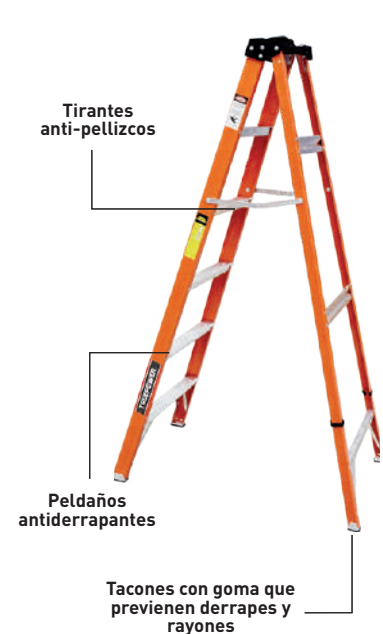

CÓDIGO	ALTURA TOTAL	CAPACIDAD DE CARGA	PRECIO	INNER
TPETFV6	1.82 m (6 ft)	150 kg	\$ 2,060.00	1

**Escaleras de extensión**  
Aluminio / Tipo III comercial, Tipo II profesional

Guías de deslizamiento  
Pestillo de rápida fijación

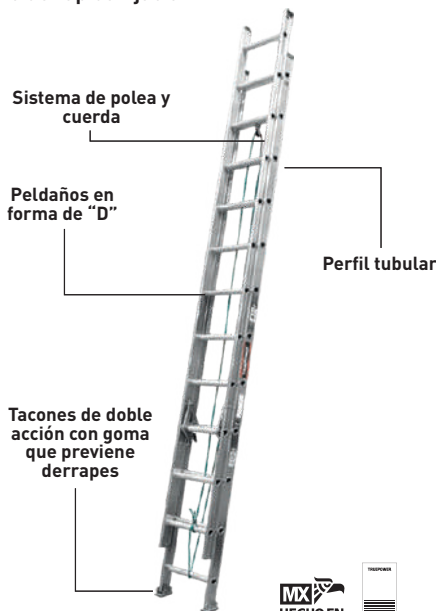

CÓDIGO	ALTURA TOTAL	C. DE CARGA	PRECIO	INNER
TPEEA15016	4.88 m (16 ft)	150 kg	\$ 2,750.00	1
TPEEA15020	6.10 m (20 ft)		\$ 3,310.00	1
TPEEA15024	7.32 m (24 ft)		\$ 4,230.00	1
TPEEA17524	7.32 m (24 ft)	175 kg	\$ 4,685.00	1
TPEEA17528	8.53 m (28 ft)		\$ 6,530.00	1
TPEEA17532	9.75 m (32 ft)		\$ 7,830.00	1

**Escalera de extensión**  
Fibra de vidrio / Tipo II profesional

Guías de deslizamiento  
Pestillo de rápida fijación

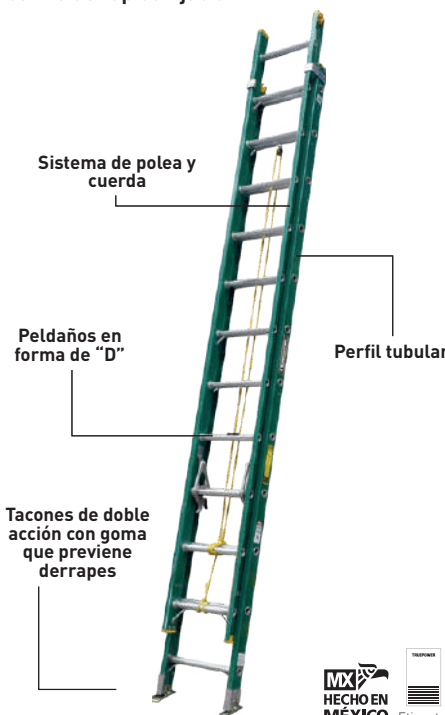

CÓDIGO	ALTURA TOTAL	CAPACIDAD DE CARGA	PRECIO	INNER
TPEEFV28	7.32 m (24 ft)	175 kg	\$ 6,200.00	1

**Alturas para escaleras de tijera**

PIES	# DE PELDAÑOS	ALTURA MÁXIMA PARA PARARSE	ALCANCE MÁXIMO DE TRABAJO
3'	2	0.30 m	2.30 m
4'	3	0.58 m	2.58 m
5'	4	0.87 m	2.87 m
6'	5	1.15 m	3.15 m
7'	6	1.46 m	3.46 m

**Alturas para escaleras de extensión**

PIES	# DE PELDAÑOS	ALTURA MÁXIMA EXTENDIDA	ALTURA MÁXIMA PARA PARARSE	ALCANCE MÁXIMO DE TRABAJO
16'	16	4.88 m	2.80 m	3.96 m
20'	20	6.10 m	3.99 m	5.18 m
24'	24	7.32 m	5.15 m	6.40 m
28'	28	8.53 m	6.35 m	7.62 m
32'	32	9.75 m	7.52 m	8.84 m

El aspecto, empaque, inner o master de los productos puede variar sin previo aviso debido a la innovación continua de nuestras marcas.

## Escalera 4 posiciones 3 x 6 peldaños

Ligera 8.5 kg  
Soporta 150 kg  
Cuerpo de aluminio  
Máxima longitud 3.4 m



CÓDIGO	PRECIO	INNER
TPESC574	\$ 2,900.00	1

## Escalera 4 posiciones 4 x 3 peldaños

Ligera 12.2 kg  
Soporta 102 kg  
Cuerpo de aluminio  
Máxima longitud 4.7 m



CÓDIGO	PRECIO	INNER
TPESC575	\$ 2,400.00	1

## Estufa portátil de gas

Ideal para uso doméstico  
o en el campo

Práctico estuche

Compacta,  
resistente y  
ligera

Sistema de  
seguridad  
contra sobre  
presión de gas

Protector contra  
viento

Control variable  
de flama

Encendido  
piezoeléctrico



Portafolio plástico

CÓDIGO	PRECIO	INNER	MASTER
TPEP328	\$ 530.00	1	6

## Matamoscas mango metálico



CÓDIGO	PRECIO	INNER	MASTER
TP181	\$ 21.00	1	100

## Linterna tempestad 28 cm



Tanque de  
350 ml



CÓDIGO	DESC.	PRECIO	INNER	MASTER
TP225R	Roja	\$ 108.00	1	24
TP225S	Plata	\$ 108.00	1	24

**Conector "Y"**

Entrada y salida de 3/4"



CÓDIGO	DESC.	PRECIO	INNER	MASTER
TPCONYP	Plástico	\$ 25.00	24	192
TPYC34	Metálico	\$ 70.00	24	144

**Juego de conectores para manguera**

Compatible con sistema click

3 Conectores machos

1 conector hembra



CÓDIGO	PRECIO	INNER	MASTER
TPJC1213	\$ 28.50	12	72

**Aspersor de plástico para riego tipo estaca**

Area de riego: 360°

Alcance a máxima presión de 8 m



CÓDIGO	PRECIO	INNER	MASTER
TPSPRP	\$ 52.00	12	48

**Manguera tricapa para jardín tramada verde 1/2"**

CÓDIGO	DESCRIPCIÓN	PRECIO	INNER	MASTER
TPMJ1275	7.5 m	\$ 110.00	1	10
TPMJ1215	15 m	\$ 190.00	1	5
TPMJ1220	20 m	\$ 220.00	1	5
TPMJ1230	30 m	\$ 290.00	1	5



**Manguera tricapa para jardín tramada verde 5/8"**

CÓDIGO	DESCRIPCIÓN	PRECIO	INNER	MASTER
TPMJ5875	7.5 m	\$ 120.00	1	5
TPMJ5815	15 m	\$ 260.00	1	5
TPMJ5830	30 m	\$ 380.00	1	5



**Juego conexión para manguera de latón**



CÓDIGO	DESCRIPCIÓN	PRECIO	INNER	MASTER
JCMB12	1/2"	\$ 35.00	50	500
JCMB58	5/8"	\$ 45.00	1	120

**Conexión para manguera latón macho**



CÓDIGO	DESCRIPCIÓN	PRECIO	INNER	MASTER
CMM12	1/2"	\$ 15.50	50	500
CMM58	5/8"	\$ 16.50	50	500

**Conexión para manguera de latón hembra**



CÓDIGO	DESCRIPCIÓN	PRECIO	INNER	MASTER
CHM12	1/2"	\$ 23.00	50	500
CHM58	5/8"	\$ 25.00	50	500

**Reparador plástico para manguera**



CÓDIGO	DESCRIPCIÓN	PRECIO	INNER	MASTER
TPRP1178	1/2"	\$ 19.00	12	72
TPRP1175	5/8" - 3/4"	\$ 20.00	12	72

**Conector plástico hembra para manguera**



CÓDIGO	DESCRIPCIÓN	PRECIO	INNER	MASTER
TPCP1180	1/2"	\$ 15.00	12	72
TPCP1177	5/8" - 3/4"	\$ 17.00	12	72

**Conector plástico macho para manguera**



CÓDIGO	DESC.	PRECIO	INNER	MASTER
TPCP1179	1/2"	\$ 14.00	12	72
TPCP1176	5/8" - 3/4"	\$ 17.00	12	72

**Manguera de nivel 100 m Precio por metro: \$ 1**



CÓDIGO	DESCRIPCIÓN	PRECIO POR METRO	PRECIO	INN.	MAS.
TPMN14	1/4" 55 psi	\$ 2.50	\$ 250.00	1	6
TPMN516	5/16" 50 psi	\$ 3.90	\$ 390.00	1	5
TPMN38	3/8" 40 psi	\$ 4.80	\$ 480.00	1	4

**Aspersor de metálico para riego tipo estaca**

Area de riego: 360°

Estaca de zinc 20 cm de largo

Alcance a máxima presión de 8 m



CÓDIGO	PRECIO	INNER	MASTER
TPAE1067	\$ 190.00	12	48

**Manguera tricapa para jardín tramada verde 100 m**

CÓDIGO	DESCRIPCIÓN	PRECIO	INNER	MASTER
TPMJ1275	7.5 m	\$ 110.00	1	10
TPMJ1215	15 m	\$ 190.00	1	5
TPMJ1220	20 m	\$ 220.00	1	5
TPMJ1230	30 m	\$ 290.00	1	5



**Manguera tricapa para jardín tramada verde 100 m**

CÓDIGO	DESC.	PRECIO POR METRO	PRECIO	INNER
TPMJTV100	1/2"	\$ 7.00	\$ 700.00	1
TPMJ58100	5/8"	\$ 12.00	\$ 1,200.00	1



60 psi

3 Capas que la hacen más resistentes



Conexiones de latón inoxidables

**Manguera tricapa para jardín tramada verde 100 m**

75 psi



CÓDIGO	DESC.	PRECIO POR METRO	PRECIO	INNER
TPMJTV100	1/2"	\$ 7.00	\$ 700.00	1
TPMJ58100	5/8"	\$ 12.00	\$ 1,200.00	1

El aspecto, empaque, inner o master de los productos puede variar sin previo aviso debido a la innovación continua de nuestras marcas.

### Chiflón para manguera 4" 2 funciones plástico



Boquilla regulable



CÓDIGO	PRECIO	INNER	MASTER
TPWG2L	\$ 20.00	24	192

### Chiflón para manguera Cuerpo de latón



TPWG3B



CÓDIGO	DESC.	PRECIO	INNER	MASTER
TPWG3B	3"	\$ 66.00	24	192
TPWG4B	4"	\$ 98.00	12	144

### Pistola para jardín de plástico 5 1/2" Clip para flujo continuo



CÓDIGO	PRECIO	INNER	MASTER
TPHS1P	\$ 26.00	10	100

### Pistola para jardín cromada metálica Clip para flujo continuo



CÓDIGO	PRECIO	INNER	MASTER
TPHS1	\$ 82.00	10	100

### Pistola para jardín metálica con forro Clip para flujo continuo



CÓDIGO	PRECIO	INNER	MASTER
TPHS2	\$ 105.00	24	72

### Pistola para jardín de plástico regulable Clip para flujo continuo



CÓDIGO	PRECIO	INNER	MASTER
TPPJ1109	\$ 66.00	12	60

### Pistola para jardín multiusos punta de latón Clip para flujo continuo



CÓDIGO	PRECIO	INNER	MASTER
TPWG1	\$ 120.00	6	48

### Pistola para jardín Clip para flujo continuo



CÓDIGO	PRECIO	INNER	MASTER
TPWG7	\$ 50.00	12	96

### Pistola para jardín de plástico Clip para flujo continuo



CÓDIGO	PRECIO	INNER	MASTER
TPWG5	\$ 40.00	12	96

### Pistola para jardín de plástico Clip para flujo continuo



CÓDIGO	PRECIO	INNER	MASTER
TPWG8	\$ 65.00	12	48

### Manguera expandible para jardín con pistola



Caja a color

CÓDIGO	DESCRIPCIÓN	PRECIO	INNER	MASTER
TPME1732	2.5 - 7.5 m	\$ 140.00	1	32
TPME1733	5 - 15 m	\$ 210.00	1	24
TPME1734	7.5 - 22.5 m	\$ 260.00	1	18

#### CARACTERÍSTICAS

- Manguera elástica capaz de expandir su tamaño 3 veces con la ayuda de la presión del agua
- Gran resistencia al desgaste con el uso
- Fácil de almacenar
- Alta durabilidad
- Fácil de enrollar
- Fácil de transportar
- Ligera

**Bomba fumigadora**

Bombeo por pistón central



**CARACTERÍSTICAS**

Presión de trabajo: 38 psi

Largo pipeta: 43 cm

Diámetro de manguera: 3/8"

Largo manguera: 120 cm

CÓDIGO	DESC.	PRECIO	INNER	MASTER
TPSPR5	5 L	\$ 300.00	1	6
TPSPR8	8 L	\$ 340.00	1	6

**Fumigador mochila para uso agrícola**



Tanque translucido que permite ver el contenido



**CARACTERÍSTICAS**

Útil para aplicar fertilizantes y pesticidas

Incluye 2 boquillas

Puede operarse con ambas manos

Correas ajustables

Asa para transporte

CÓDIGO	PRECIO	INNER	MASTER
TPFM1159	\$ 680.00	1	1

**Pistola para jardín con extensión 32"**



CÓDIGO	PRECIO	INNER	MASTER
TPPJ1224	\$ 155.00	6	36

**Fumigador doméstico 1.2 L**

Reforzado



Boquilla de latón



CÓDIGO	PRECIO	INNER	MASTER
TPFD416	\$ 95.00	1	20

**Atomizador**

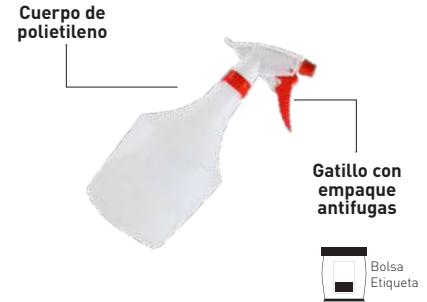

CÓDIGO	DESC.	PRECIO	INNER	MASTER
TPA414	500 ml	\$ 30.00	1	80
TPA415	900 ml	\$ 35.00	1	42

**Fumigador doméstico 2 L**

Reforzado



Boquilla de latón



CÓDIGO	PRECIO	INNER	MASTER
TPFD417	\$ 127.00	1	20



**Juego de herramientas para jardín 4 piezas**

Cuchara mango 6"

Bieldo mango 6"

Trasplantador 6"

Cultivador 6"



CÓDIGO	PRECIO	INNER	MASTER
TPJHJ594	\$ 160.00	1	12

**Hilo para desbrozadora**

Uso residencial



CÓDIGO	DESCRIPCIÓN	PRECIO	INN.	MAS.
TPHD1229	1.65 mm x 15 m	\$ 22.00	12	72
TPHD1230	2 mm x 15 m	\$ 25.00	12	72
TPHD1231	2.4 mm x 12 m	\$ 28.00	12	72
TPHD1232	2.7 mm x 12 m	\$ 30.00	12	72

**Cortador de ramas 12"**

Para cortar ramas pequeñas y medianas

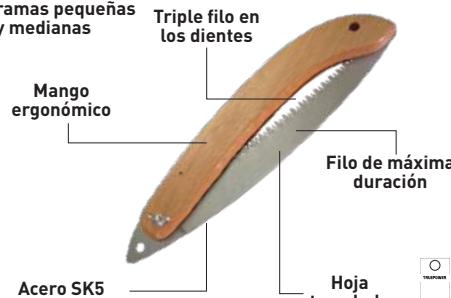

CÓDIGO	PRECIO	INNER	MASTER
TPCR615	\$ 180.00	6	24

**Cortador de ramas 14"**

Para cortar ramas pequeñas y medianas



CÓDIGO	PRECIO	INNER	MASTER
TPCR614	\$ 165.00	6	24

## Tijera aguacatera 5 1/2"

Para frutos delicados

Puntas redondas para no maltratar los frutos

Diámetro de corte 1"

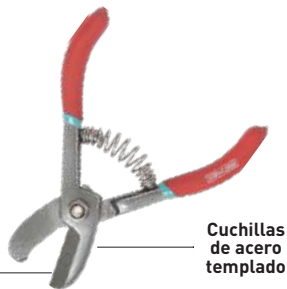

Cuchillas de acero templado



Blister Doble

CÓDIGO	PRECIO	INNER	MASTER
TPTA1125	\$ 102.00	6	36

## Tijera para poda 8"

Hoja curva



Blister

CÓDIGO	PRECIO	INNER	MASTER
TPTF8	\$ 100.00	12	72

## Tijera recta 8"

Multusos

Mango rubber



Hoja dentada para evitar deslizamiento



Blister Doble

CÓDIGO	PRECIO	INNER	MASTER
TPTR1122	\$ 120.00	6	36

## Tijera para poda 8 1/2"

Diámetro de corte 3/4"

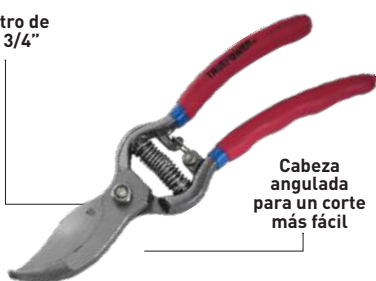

Cabeza angulada para un corte más fácil

Hojas de acero templado



Blister Doble

CÓDIGO	PRECIO	INNER	MASTER
TPTF1123	\$ 110.00	6	36

## Tijera para poda 9"

Capacidad de corte 3/4"



Hoja de acero templado



Blister Doble

CÓDIGO	PRECIO	INNER	MASTER
TPTA1124	\$ 155.00	6	36

## Tijeras para podar 2 manos 21"



Mango de madera



Etiqueta

CÓDIGO	PRECIO	INNER	MASTER
TPHS21W	\$ 172.00	6	12

## Tijera para jardín mangos tubulares 12"

Espesor de la hoja 4 mm



Mango de aluminio



Etiqueta

CÓDIGO	PRECIO	INNER	MASTER
TPTT1108	\$ 208.00	6	12

## Tijeras para ramas 21"

Hojas de corte de acero forjado



Mango de madera



Etiqueta

CÓDIGO	PRECIO	INNER	MASTER
TPTR408	\$ 269.00	24	96

## Tijera para podar telescópica (24" a 33")

Hojas de corte de acero forjado

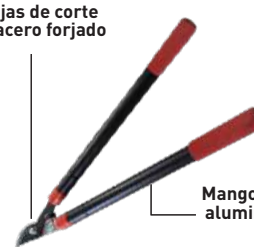

Mango de aluminio



Etiqueta

CÓDIGO	PRECIO	INNER	MASTER
TPTT2433	\$ 290.00	1	12

## Escoba de jardín plástico c/bastón de madera 22D x 22" x 48"



Etiqueta

CÓDIGO	PRECIO	INNER	MASTER
TPPR1822	\$ 126.00	1	24

## Escoba de jardín metálica con bastón madera 24D x 24" x 48"



Etiqueta

CÓDIGO	PRECIO	INNER	MASTER
TPCR10D2W	\$ 165.00	1	12

## Escoba jardín metálica con bastón madera 22D x 22" x 48"



Etiqueta

CÓDIGO	PRECIO	INNER	MASTER
TPEJ593	\$ 122.00	1	24

**Bomba de agua eléctrica periférica**

Para elevación de cisterna a tinaco  
Embobinado de cobre  
Impelente de latón  
Tensión: 110 V ~  
Frecuencia: 60 Hz



**50**  
MINUTOS DE TRABAJO

**20**  
MINUTOS DE DESCANSO



	TPEWP12	TPEWP34	TPEWP1
ENTRADA Y SÁLIDA	1"	1"	1"
POTENCIA	1/2 HP	3/4 HP	1 HP
ALTURA MÁXIMA	40 m	50 m	60 m
INTENSIDAD	3.7 A	5.5 A	7 A
PRECIO	\$900.00	\$1,550.00	\$1,700.00
MASTER	6	2	2

**Bomba de agua eléctrica periférica**

Para elevación de cisterna a tinaco  
Embobinado de aluminio  
Impelente de latón  
Conexiones de 1" NPT  
Tensión: 110 V ~  
Frecuencia: 60 Hz



**50**  
MINUTOS DE TRABAJO

**20**  
MINUTOS DE DESCANSO



	TPWP676	TPWP677	TPWP1065
ENTRADA Y SÁLIDA	1"	1"	1"
POTENCIA	1/2 HP	3/4 HP	1 HP
ALTURA MÁXIMA	30 m	42 m	50 m
INTENSIDAD	3.7 A	5.5 A	7 A
PRECIO	\$820.00	\$1,400.00	\$1,500.00
MASTER	6	2	2

**Bomba tipo jet**

Armazón de acero inoxidable  
Embobinado de cobre  
Impelente de latón  
Conexiones de 1" NPT  
Tensión: 110 V ~  
Frecuencia: 60 Hz  
Uso doméstico y agrícola



**50**  
MINUTOS DE TRABAJO

**20**  
MINUTOS DE DESCANSO



	TPWP684	TPWP685	TPWP686
POTENCIA	1/2 HP	3/4 HP	1 HP
ALTURA MÁXIMA	30 m	42 m	50 m
INTENSIDAD	4 A	6 A	8 A
PRECIO	\$2,000.00	\$2,400.00	\$3,000.00
MASTER	2	2	2

**Presurizador automático 1/6 HP**

Cuerpo de hierro  
Embobinado de cobre  
Impelente de polipropileno  
Buje de cerámica  
Conexiones 1/2" NPT  
Tensión: 115 V ~  
Frecuencia: 60 Hz



	ALTURA MÁXIMA	LITROS X MIN	PRECIO	INNER
TPBM693	9 m	27	\$1,590.00	8

**Membrana para equipo hidroneumático**

Fabricado de caucho natural

Con tornillo de sujeción



CÓDIGO	DESC.	PRECIO	INNER	MASTER
TPME1188	24 L	\$145.00	1	50
TPME1189	36 L	\$160.00	1	25
TPME1190	50 L	\$420.00	1	25
TPME1191	80 L	\$550.00	1	20

**Impulsor para bomba de agua eléctrica**

Material polipropileno



CÓDIGO	PRECIO	INNER	MASTER
IWP694	\$240.00	1	24

**Switch de presión para hidroneumático**

Cuerpo metálico

Cubierta de plástico

Entrada de caucho



CÓDIGO	PRECIO	INNER	MASTER
TPSP680	\$143.00	1	50

**Tanque precargado horizontal**

Precarga 30 psi

Cuerpo de acero

Conexión roscable 1" NPT

Soporte para bomba



CÓDIGO	DESC.	PRECIO	INNER	MASTER
TPTH678	24 L	\$700.00	1	1
TPTH679	36 L	\$850.00	1	1
TPTH1063	50 L	\$1,350.00	1	1
TPTH1064	80 L	\$2,100.00	1	1

**Manguera flexible para hidroneumático**

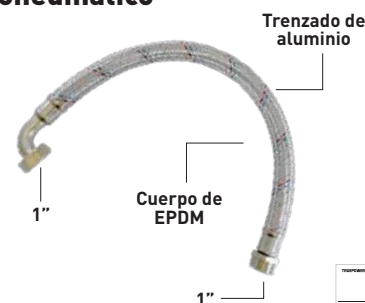

Trenzado de aluminio

Cuerpo de EPDM



CÓDIGO	PRECIO	INNER	MASTER
TPMH683	\$315.00	1	50

**Conector de latón para hidroneumático 5 vías**



CÓDIGO	PRECIO	INNER	MASTER
TPCB682	\$156.00	1	100

**Manómetro**

Cuerpo metálico

Cubierta de plástico

Conector metálico 1/4"



Con glicerina



CÓDIGO	PRECIO	INNER	MASTER
TPRG1192	\$195.00	1	100
TPRAM681	\$140.00	1	200

El aspecto, empaque, inner o master de los productos puede variar sin previo aviso debido a la innovación continua de nuestras marcas.



Todos los equipos hidroneumáticos incluyen:



Conector de 5 vías



Manómetro con glicerina



Switch de presión



Manguera flexible

### Equipo hidroneumático bomba 1/2 HP Tanque de 24 L

#### CARACTERÍSTICAS

- Embobinado de aluminio
- Impelente de latón
- Estator de 40 mm
- Motor 110 V ~ 60 Hz 1/2 HP
- Succión 9 m
- Capacidad máxima 35 L por minuto
- Tanque base para bomba 24 L
- Membrana intercambiable
- Construido en acero de alta calidad
- Ahorra espacio



**CÓDIGO**  
TPEH687

**PRECIO**  
\$ 2,185.00

**INNER**  
1

### Equipo hidroneumático bomba 3/4 HP Tanque de 36 L

#### CARACTERÍSTICAS

- Embobinado de aluminio
- Impelente de latón
- Estator de 50 mm
- Motor 110 V ~ 60 Hz 3/4 HP
- Succión 9 m
- Capacidad máxima 45 L por minuto
- Tanque base para bomba 36 L
- Membrana intercambiable
- Construido en acero de alta calidad
- Ahorra espacio



**CÓDIGO**  
TPEH688

**PRECIO**  
\$ 2,850.00

**INNER**  
1

### Equipo hidroneumático bomba 1/2 HP Tanque de 24 L

#### CARACTERÍSTICAS

- Bomba Jet
- Embobinado de cobre
- Impelente de latón
- Motor 110 V ~ 60 Hz 1/2 HP
- Succión 9 m
- Capacidad máxima 40 L por minuto
- Tanque base para bomba 24 L
- Membrana intercambiable
- Construido en acero de alta calidad
- Ahorra espacio



**CÓDIGO**  
TPEH689

**PRECIO**  
\$ 3,400.00

**INNER**  
1

### Equipo hidroneumático bomba 3/4 HP Tanque de 36 L

#### CARACTERÍSTICAS

- Bomba Jet
- Embobinado de cobre
- Impelente de latón
- Motor 110 V ~ 60 Hz 3/4 HP
- Succión 9 m
- Capacidad máxima 50 L por minuto
- Tanque base para bomba 36 L
- Membrana intercambiable
- Construido en acero de alta calidad
- Ahorra espacio

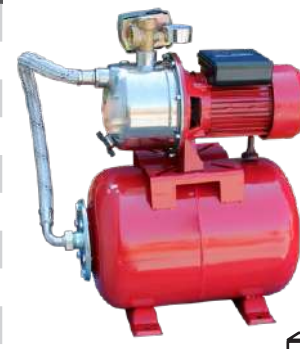

**CÓDIGO**  
TPEH690

**PRECIO**  
\$ 4,200.00

**INNER**  
1

### Equipo hidroneumático bomba 1 HP Tanque de 50 L

#### CARACTERÍSTICAS

- Bomba Jet
- Embobinado de cobre
- Impelente de latón
- Motor 110 V ~ 60 Hz 1 HP
- Succión 9 m
- Capacidad máxima 60 L por minuto
- Tanque base para bomba 50 L
- Membrana intercambiable
- Construido en acero de alta calidad
- Ahorra espacio



**CÓDIGO**  
TPEH691

**PRECIO**  
\$ 4,490.00

**INNER**  
1

### Equipo hidroneumático bomba 1 1/2 HP Tanque de 80 L

#### CARACTERÍSTICAS

- Bomba Jet
- Embobinado de cobre
- Impelente de polipropileno
- Motor 110 V ~ 60 Hz 1 1/2 HP
- Succión 9 m
- Capacidad máxima 80 L por minuto
- Tanque base para bomba 80 L
- Membrana intercambiable
- Construido en acero de alta calidad
- Ahorra espacio



**CÓDIGO**  
TPEH692

**PRECIO**  
\$ 6,370.00

**INNER**  
1



**Llave de cruz universal**

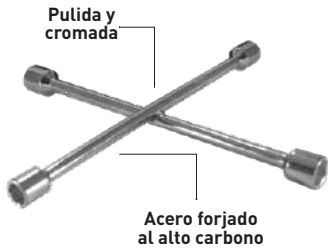

CÓDIGO	DESCRIPCIÓN	PRECIO	INNER	MASTER
TPLLC14	14"	\$ 132.00	1	12
TPLLC18	18"	\$ 182.00	1	12
TPLLC20	20"	\$ 190.00	1	12

**Lubricante aflojatodo**

Limpia, penetra y protege  
Desplaza la humedad  
Lubrica  
Afloja piezas oxidadas



CÓDIGO	DESCRIPCIÓN	PRECIO	INNER	MASTER
TP1050	250 ml	\$ 36.00	1	24
TP1051	400 ml	\$ 50.00	1	24

**Desengrasante para motores**

Para todo tipo de vehículos  
Remueve con facilidad grasa y aceite



CÓDIGO	DESCRIPCIÓN	PRECIO	INNER	MASTER
TP1054	650 ml	\$ 77.00	1	12

**Candado para volante de auto**



CÓDIGO	PRECIO	INNER	MASTER
TPCATSLA	\$ 255.00	1	6

**Grasa blanca de litio**

Lubricación duradera  
Previene la oxidación y la corrosión  
Reduce la fricción



CÓDIGO	DESCRIPCIÓN	PRECIO	INNER	MASTER
TP1053	400 ml	\$ 72.00	1	12

**Limpiador para carburador**

Remueve goma, lodo, polvo y barniz  
Limpia la válvula PCV y obturador  
Para todo tipo de motores de gasolina



CÓDIGO	DESCRIPCIÓN	PRECIO	INNER	MASTER
TP1055	450 ml	\$ 51.00	1	12

**Candado bastón para volante de auto**

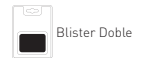

CÓDIGO	PRECIO	INNER	MASTER
TPCATSL	\$ 200.00	1	12

**Infallantas con manguera**

Infla y sella en segundos  
No contamina  
Gran poder de sellado  
Solo para llantas de automóviles



CÓDIGO	DESCRIPCIÓN	PRECIO	INNER	MASTER
TP1052	400 ml	\$ 63.00	1	12

**Silicón RTV**

Para formar juntas de motor

75 g



CÓDIGO	DESCRIPCIÓN	PRECIO	INNER	MASTER
TP1060	Rojo	\$ 36.00	12	144
TP1061	Gris	\$ 36.00	12	144
TP1062	Negro	\$ 36.00	12	144

El aspecto, empaque, inner o master de los productos puede variar sin previo aviso debido a la innovación continua de nuestras marcas.

## Gato patín 2 tolenadas

Fabricado en acero y hierro fundido  
Longitud del chasis: 417 mm  
Ancho del chasis: 197 mm

Válvula de seguridad que previene la sobrecarga



Altura mínima: 135 mm  
Altura máxima: 300 mm

Longitud del maneral: 370 mm



CÓDIGO

TPTJ2  
TPTJ2EP

PRECIO

\$ 650.00  
\$ 675.00

INNER

1  
1

## Cable pasa corriente calibre 10 x 12 ft



CÓDIGO  
TPJC10

PRECIO  
\$ 150.00

INNER  
1

MASTER  
20

## Cable pasa corriente calibre 4 x 16 ft



CÓDIGO  
TPJC416

PRECIO  
\$ 300.00

INNER  
1

MASTER  
12

## Llave quita filtro de aceite



CÓDIGO

TPLF1157  
TPLF1158

DESCRIPCIÓN

2 1/2" - 3 1/4"  
3 1/4" - 3 3/4"

PRECIO

\$ 95.00  
\$ 95.00

INNER

6  
6

MASTER

36  
36

## Cepillo limpiador de terminal de batería

Cerdas de alambre de acero  
Construcción fuerte de metal

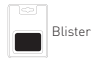

CÓDIGO  
TPPTC2W

PRECIO  
\$ 41.00

INNER  
12

MASTER  
144

## Juego de terminales para batería 2 piezas

Cuerpo de latón  
Poste superior

Para cable 6 a 1 AWG



CÓDIGO  
TP188

PRECIO  
\$ 82.00

INNER  
12

MASTER  
96

## Juego de terminales para batería 10 piezas

De plomo

Poste lateral

Para cable 6 a 1 AWG



CÓDIGO  
TPBTS10

PIEZA  
\$ 24.00

PAQUETE  
\$ 240.00

INNER  
1

MASTER  
24

## Juego de terminales para batería 10 piezas

De plomo

Poste superior

Para cable 6 a 1 AWG



CÓDIGO  
TPBT10

PIEZA  
\$ 22.00

PAQUETE  
\$ 220.00

INNER  
1

MASTER  
24

## Bola jalón para remolque



CÓDIGO

TPHBAL2000  
TPHBAL3500L  
TPHBAL21L  
TPHBAL5000L

DESCRIPCIÓN  
1 7/8" x 2 1/2" 2000 lb  
2" x 3/4" x 2 1/2" 3500 lb  
2" x 1" x 2 1/2" 5000 lb  
2 5/16" x 1" x 2 1/2" 5000 lb

PRECIO  
\$ 135.00  
\$ 165.00  
\$ 165.00  
\$ 240.00

INN.  
6  
6  
6  
3

MAS.  
24  
24  
24  
12



## Cople para remolque uso pesado 2" 5000 lb



CÓDIGO  
TPCR454

PRECIO  
\$ 560.00

INNER  
1

MASTER  
6

## Cople remolque



CÓDIGO

TPTC2000M  
TPTC3500M  
TPTC3500L

DESCRIPCIÓN  
1 7/8" x 2 1/2" 2000 lb  
2" x 2 1/2" 3500 lb  
2" x 3" 3500 lb

PRECIO  
\$ 240.00  
\$ 360.00  
\$ 380.00

INN.  
1  
1  
1

MAS.  
20  
8  
8

**Sujetador con matraca**  
**2 piezas**

Ideal para autos y motocicletas

Ancho de banda 1"



Contenedor etiqueta

CÓDIGO	DESCRIPCIÓN	PRECIO	INNER	MASTER
TPSM347	1" X 3" m Carga Max. 675 kg	\$ 190.00	5	10
TPSM348	1" X 4" m Carga Max. 1125 kg	\$ 305.00	5	10

**Sujetador con matraca**  
**2 piezas**

Ideal para camiones y trailers

Ancho de banda 2" x 9 m

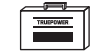

Contenedor etiqueta

CÓDIGO	DESCRIPCIÓN	PRECIO	INN.	MAS.
TPSM350	Carga 3000 kg	\$ 440.00	3	6
TPSM351	Carga 5000 kg	\$ 545.00	3	6

**Sujetador con matraca**  
**2 piezas**

Ancho de banda 1/2" x 5 m

Carga Máxima: 2250 kg



Contenedor etiqueta

CÓDIGO	PRECIO	INNER	MASTER
TPSM349	\$ 290.00	1	50

**Correa con ganchos para remolque**  
**2" X 6 m**

Ideal para camiones y trailers

Ancho de banda 2"

Carga Máxima: 4500 kg

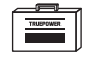

Contenedor etiqueta

CÓDIGO	PRECIO	INNER	MASTER
TPSJ354	\$ 280.00	1	20

**Sujetadores con matraca**  
**4 piezas**

Ideal para camiones y trailers

Ancho de banda 1" x 1.8 m

Carga Máxima: 410 kg



Contenedor etiqueta

CÓDIGO	PRECIO	INNER	MASTER
TPSS353	\$ 400.00	5	10

**Tensores elásticos paquete con 10 piezas**



Bolsa Etiqueta

CÓDIGO	DESCRIPCIÓN	PIEZA	PAQUETE	INNER	MASTER
TPBS189	18"	\$ 13.50	\$ 135.00	1	32
TPBS249	24"	\$ 17.00	\$ 170.00	1	24
TPBS309	30"	\$ 19.50	\$ 195.00	1	20
TPBS369	36"	\$ 22.50	\$ 225.00	1	16
TPBS489	48"	\$ 28.00	\$ 280.00	1	12
TPBS649	64"	\$ 36.00	\$ 360.00	1	8

El aspecto, empaque, inner o master de los productos puede variar sin previo aviso debido a la innovación continua de nuestras marcas.

# TRUEPOWER®

# NUEVOS DISCOS LAMINADOS

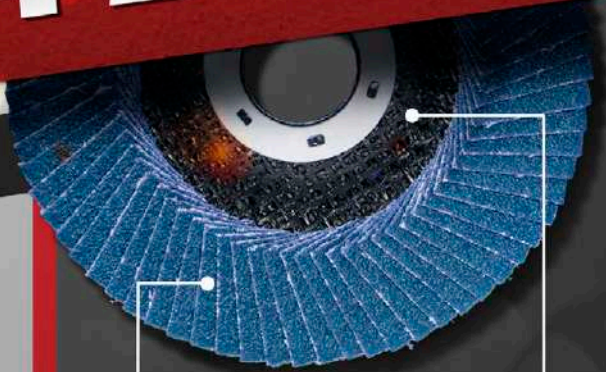

## DISCO LAMINADO 4"

CÓDIGO GRANO

TP1070	40
TP1071	60
TP1072	80
TP1073	120

BARRENO  
5/8"



## DISCO LAMINADO 4 1/2"

CÓDIGO GRANO

TP1074	40
TP1075	60
TP1076	80
TP1077	120

BARRENO  
7/8"



## DISCO LAMINADO 7"

CÓDIGO GRANO

TP1078	40
TP1079	60
TP1080	80
TP1081	120

BARRENO  
7/8"

Abrasivo de Zirconio

Respaldo de Fibra de vidrio

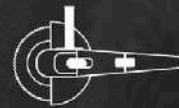

Para esmeriladora angular



15° A 25°

TIPO  
29

[www.anbec.com](http://www.anbec.com)  
[ventas@anbec.com](mailto:ventas@anbec.com)

**GRUPO ANBEC**

# STROM<sup>®</sup>

MATERIAL ELÉCTRICO

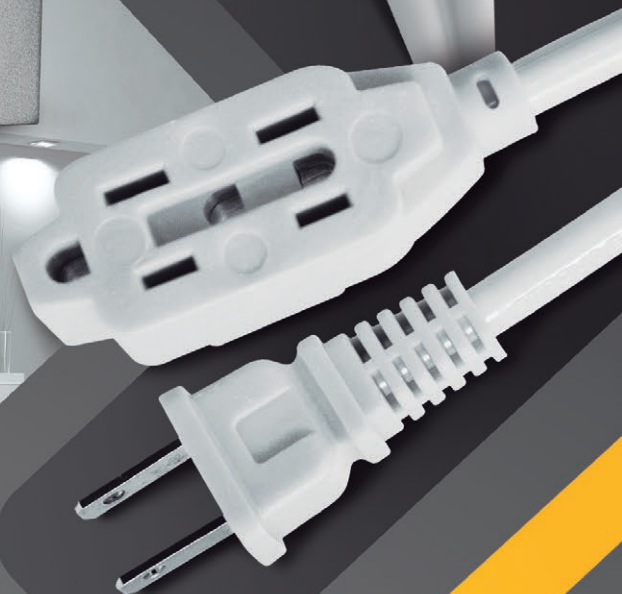

## Linterna cabeza 3 LEDS SMD

Cuerpo de ABS



ESPECIFICACIONES TÉCNICAS			
Flujo luminoso	80 Lúmenes		
CÓDIGO	PRECIO	INNER	MASTER
ST2620	\$ 95.00	6	48

## Linterna cabeza 10 LEDS

Cuerpo de ABS



ESPECIFICACIONES TÉCNICAS			
Flujo luminoso	40 Lúmenes		
CÓDIGO	PRECIO	INNER	MASTER
ST2623	\$ 120.00	6	48

## Linterna cabeza 4 LEDS SMD

Alta eficiencia  
Cuerpo de ABS



ESPECIFICACIONES TÉCNICAS			
Flujo luminoso	110 Lúmenes		
CÓDIGO	PRECIO	INNER	MASTER
ST2622	\$ 110.00	6	48

## Linterna cabeza 1 LED COB

Alta eficiencia  
Cuerpo de ABS



ESPECIFICACIONES TÉCNICAS			
Flujo luminoso	120 Lúmenes		
CÓDIGO	PRECIO	INNER	MASTER
ST2621	\$ 120.00	6	48

## Linterna de toque 3 LEDS

Juego con 2 piezas  
Cuerpo de ABS



ESPECIFICACIONES TÉCNICAS			
Flujo luminoso	13 Lúmenes		
CÓDIGO	PRECIO	INNER	MASTER
ST2630	\$ 66.00	12	48

## Linterna de toque 3 LEDS

Juego con 2 piezas  
Cuerpo de ABS



ESPECIFICACIONES TÉCNICAS			
Flujo luminoso	13 Lúmenes		
CÓDIGO	PRECIO	INNER	MASTER
ST2631	\$ 75.00	12	48

## Linterna tipo pluma 6 LEDS SMD

Cuerpo de ABS



ESPECIFICACIONES TÉCNICAS			
Flujo luminoso	110 Lúmenes		
CÓDIGO	PRECIO	INNER	MASTER
ST2653	\$ 110.00	12	48

## Linterna de taller 1 COB y 1 LED

Alta eficiencia



ESPECIFICACIONES TÉCNICAS			
COB	LED		
3 W	1 W		
Flujo luminoso	64 Lúmenes		
CÓDIGO	PRECIO	INNER	MASTER
ST2650	\$ 118.00	4	24

## Linterna de taller 1 COB

Alta eficiencia



ESPECIFICACIONES TÉCNICAS			
Potencia	3 W		
Flujo luminoso	150 Lúmenes		
CÓDIGO	PRECIO	INNER	MASTER
ST2651	\$ 118.00	4	24

El aspecto, empaque, inner o master de los productos puede variar sin previo aviso debido a la innovación continua de nuestras marcas.

## Linterna recargable 15 LEDS

Clavija retráctil  
Cuerpo de ABS



**NOM**



### ESPECIFICACIONES TÉCNICAS

Flujo luminoso	45 Lúmenes
Batería recargable	4 Vcc / 800 mA

CÓDIGO	PRECIO	INNER	MASTER
ST2610	\$ 130.00	6	36

## Linterna recargable 1 LED

Alta potencia  
Clavija retráctil  
Cuerpo de ABS



**NOM**



### ESPECIFICACIONES TÉCNICAS

Potencia	1 W
Flujo luminoso	100 Lúmenes
Batería recargable	4 Vcc / 800 mA

CÓDIGO	PRECIO	INNER	MASTER
ST2607	\$ 134.00	6	36

## Linterna recargable 11 LEDS

Clavija retráctil  
Cuerpo de ABS



**NOM**



### ESPECIFICACIONES TÉCNICAS

Flujo luminoso	26 Lúmenes
Batería recargable	4 Vcc / 1000 mA
Luz alta	11 LEDS
Luz baja	6 LEDS

CÓDIGO	PRECIO	INNER	MASTER
ST2602	\$ 140.00	6	36

## Linterna recargable 1 LED

Alta potencia  
Clavija retráctil  
Cuerpo de ABS



**NOM**



### ESPECIFICACIONES TÉCNICAS

Potencia	3 W
Flujo luminoso	150 Lúmenes
Batería recargable	4 Vcc / 1000 mA

CÓDIGO	PRECIO	INNER	MASTER
ST2601	\$ 205.00	6	36

## Linterna recargable 1 LED

Alta potencia  
Clavija retráctil  
Cuerpo de ABS



**NOM**



### ESPECIFICACIONES TÉCNICAS

Potencia	3 W
Flujo luminoso	70 Lúmenes
Batería recargable	4 Vcc / 500 mA

CÓDIGO	PRECIO	INNER	MASTER
ST2603	\$ 121.00	6	36

## Linterna recargable 19 LEDS

Clavija retráctil  
Cuerpo de ABS



**NOM**



### ESPECIFICACIONES TÉCNICAS

Flujo luminoso	60 Lúmenes
Batería recargable	4 Vcc / 500 mA
Luz alta	19 LEDS
Luz baja	7 LEDS

CÓDIGO	PRECIO	INNER	MASTER
ST2604	\$ 205.00	4	16

El aspecto, empaque, inner o master de los productos puede variar sin previo aviso debido a la innovación continua de nuestras marcas.



**Luz blanca y roja para bicicleta**  
**5 LEDS**  
 3 Tipos de luces



CÓDIGO	PRECIO	INNER	MASTER
ST2660	\$ 170.00	6	24

**Luz blanca y roja para bicicleta**  
**9 LEDS**  
 7 Tipos de luces



CÓDIGO	PRECIO	INNER	MASTER
ST2663	\$ 128.00	6	24

## Luz de emergencia 60 LEDS

Enciende automáticamente al fallar la energía eléctrica

Incluye cable cargador de 127 V~



ESPECIFICACIONES TÉCNICAS			
Flujo luminoso	150 Lúmenes		
CÓDIGO	PRECIO	INNER	MASTER
ST2641	\$ 390.00	4	16

## Luz de emergencia 30 LEDS

Enciende automáticamente al fallar la energía eléctrica

Incluye cable cargador de 127 V~



ESPECIFICACIONES TÉCNICAS			
Flujo luminoso	300 Lúmenes		
CÓDIGO	PRECIO	INNER	MASTER
ST2640	\$ 265.00	4	16

## Parrilla eléctrica blanca 1 quemador

Encendido electrónico



ESPECIFICACIONES TÉCNICAS				
Potencia	1,000 W			
CÓDIGO	DESCRIPCIÓN	PRECIO	INNER	MASTER
ST2670	210 x 60 x 210 mm	\$ 175.00	1	12

## Parrilla eléctrica blanca 2 quemadores

Encendido electrónico

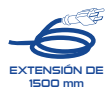

ESPECIFICACIONES TÉCNICAS				
Potencia	2,000 W			
CÓDIGO	DESCRIPCIÓN	PRECIO	INNER	MASTER
ST2671	430 x 60 x 210 mm	\$ 310.00	1	6

El aspecto, empaque, inner o master de los productos puede variar sin previo aviso debido a la innovación continua de nuestras marcas.

**Soporte para TV 37" - 70"**

Distancia de la pared: 65-460 mm  
Funciona para TV curva

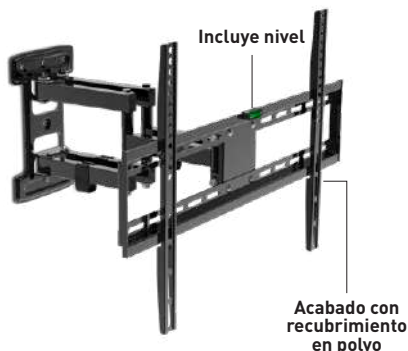

**+60°** ANGULO DE ROTACION  
**45 kg** CAPACIDAD DE CARGA  
**15** GRADOS DE INCLINACION  
 Caja a color

CÓDIGO	PRECIO	INNER	MASTER
ST9001	\$ 1,320.00	1	4

**Soporte para TV 37" - 70"**

Distancia de la pared: 25 mm  
Funciona para TV curva

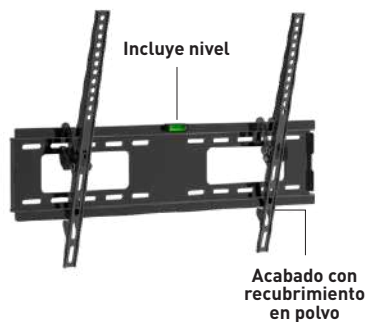

**30** CAPACIDAD DE CARGA  
**12** GRADOS DE INCLINACION  
 Caja a color

CÓDIGO	PRECIO	INNER	MASTER
ST9002	\$ 450.00	1	5

**Soporte para TV 37" - 70"**

Distancia de la pared: 25 mm  
Funciona para TV curva



**30** CAPACIDAD DE CARGA  
**NO INCLINABLE**  
 Caja a color

CÓDIGO	PRECIO	INNER	MASTER
ST9003	\$ 320.00	1	10

**Soporte para TV 37" - 55"**

Distancia de la pared: 70-375 mm  
Funciona para TV curva



**3** BRAZOS  
**180°** ANGULO DE ROTACION  
**25 kg** CAPACIDAD DE CARGA  
**15** GRADOS DE INCLINACION  
 Caja a color

CÓDIGO	PRECIO	INNER	MASTER
ST9004	\$ 660.00	1	10

**Soporte para TV 23" - 42"**

Distancia de la pared: 70-375 mm  
Funciona para TV curva

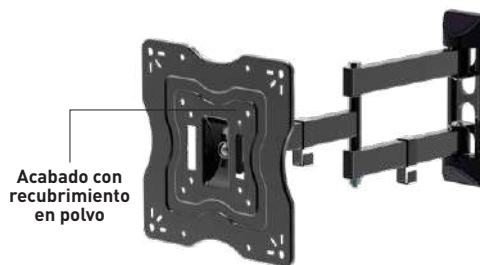

**3** BRAZOS  
**180°** ANGULO DE ROTACION  
**25 kg** CAPACIDAD DE CARGA  
**15** GRADOS DE INCLINACION  
 Caja a color

CÓDIGO	PRECIO	INNER	MASTER
ST9005	\$ 375.00	1	10

**Cable coaxial RG59**

Conductor de acero revestido de cobre

Malla de aluminio/magnesio de 64 hilos

Resistencia máxima del conductor: 183 Ω/km

Calibre 20 AWG



**75 Ω**  
Impedancia

Producto **NUEVO**

Recubrimiento de PVC color negro



Los cables de 10, 15 y 20 m incluyen puntas



CÓDIGO	DESCRIPCIÓN	PRECIO	PRECIO POR METRO	INNER	MASTER
ST2540	100 m	\$ 510.00	\$ 5.10	1	1
ST2541	300 m	\$ 1,488.00	\$ 4.96	1	1
ST2542	500 m	\$ 2,439.00	\$ 4.88	1	1
ST2550	10 m	\$ 79.00	N/A	1	1
ST2551	15 m	\$ 106.00	N/A	1	1
ST2552	20 m	\$ 134.00	N/A	1	1

**Cable coaxial RG6**

Conductor de acero revestido de cobre

Malla de aluminio/magnesio de 80 hilos

Resistencia máxima del conductor: 120 Ω/km

Calibre 18 AWG



**75 Ω**  
Impedancia

Producto **NUEVO**

Recubrimiento de PVC color negro



CÓDIGO	DESCRIPCIÓN	PRECIO	PRECIO POR METRO	INNER	MASTER
ST2545	100 m	\$ 620.00	\$ 6.20	1	1
ST2546	300 m	\$ 1,813.00	\$ 6.04	1	1
ST2547	500 m	\$ 3,000.00	\$ 6.04	1	1

## Extensión eléctrica

Uso doméstico

Producto sujeto a disponibilidad



Color verde



CÓDIGO	DESCRIPCIÓN	PRECIO	INNER	MASTER
STEV1712	2 m	\$ 25.00	12	72
STEV1713	3 m	\$ 29.00	12	72
STEV1714	4 m	\$ 35.00	12	36
STEV1715	5 m	\$ 38.00	12	36
STEV1716	6 m	\$ 46.00	12	36
STEV1717	8 m	\$ 55.00	6	18
STEV1718	10 m	\$ 61.00	6	18



## Extensión eléctrica

Uso doméstico



Color blanco



CÓDIGO	DESC.	PRECIO	INNER	MASTER
STEDB1602	2m	\$ 32.00	1	100
STEDB1603	3m	\$ 39.00	1	100
STEDB1604	4m	\$ 50.00	1	100
STEDB1605	5m	\$ 57.00	1	100
STEDB1606	6m	\$ 68.00	1	50
STEDB1608	8m	\$ 85.00	1	50
STEDB1610	10m	\$ 102.00	1	50



## Extensión eléctrica

Uso doméstico



Color verde



CÓDIGO	DESC.	PRECIO	INNER	MASTER
STEDV1602	2m	\$ 32.00	1	100
STEDV1603	3m	\$ 39.00	1	100
STEDV1604	4m	\$ 50.00	1	100
STEDV1605	5m	\$ 57.00	1	100
STEDV1606	6m	\$ 68.00	1	50
STEDV1608	8m	\$ 85.00	1	50
STEDV1610	10m	\$ 102.00	1	50



## Extensión eléctrica

Uso doméstico



Color café



CÓDIGO	DESC.	PRECIO	INNER	MASTER
STEDC1602	2m	\$ 32.00	1	100
STEDC1603	3m	\$ 39.00	1	100
STEDC1604	4m	\$ 50.00	1	100
STEDC1605	5m	\$ 57.00	1	100
STEDC1606	6m	\$ 68.00	1	50
STEDC1608	8m	\$ 85.00	1	50
STEDC1610	10m	\$ 102.00	1	50

## Extensión eléctrica

Uso rudo



CÓDIGO	DESCRIPCIÓN	PRECIO	INN.	MAS.
TPEC25163UL	25 ft (7.5 m)	\$ 180.00	1	20
TPEC50163UL	50 ft (15 m)	\$ 290.00	1	10
TPEC100163UL	100 ft (30 m)	\$ 500.00	1	6



## Extensión eléctrica

Uso rudo naranja



Producto MEJORADO NOM



CÓDIGO	DESC.	PRECIO	INNER	MASTER
STEUR1602	2m	\$ 48.00	1	100
STEUR1604	4m	\$ 65.00	1	50
STEUR1606	6m	\$ 80.00	1	40

## Extensión eléctrica

uso rudo naranja



Producto MEJORADO NOM



CÓDIGO	DESC.	PRECIO	INNER	MASTER
STEUR1608	8m	\$ 115.00	1	24
STEUR1610	10m	\$ 135.00	1	20
STEUR1615	15m	\$ 197.00	1	12
STEUR1620	20m	\$ 240.00	1	12
STEUR1625	25m	\$ 315.00	1	6
STEUR1630	30m	\$ 350.00	1	6

**Desarmador probador de corriente 140 mm**

AC  
100 - 500 V ~  
60 Hz

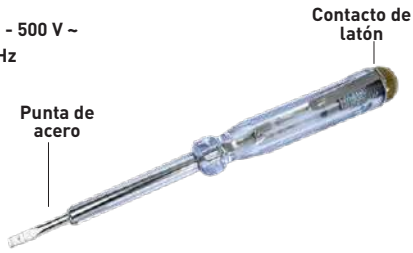

**NOM** Blister

CÓDIGO	PRECIO	INNER	MASTER
STPC1110	\$ 17.50	25	200

**Probador de circuitos 6-12 V profesional**



Clip reforzado **NOM** Blister

CÓDIGO	PRECIO	INNER	MASTER
TPCTT612P	\$ 60.00	10	100

**Probador de circuitos 6-12 V**



Clip reforzado **NOM** Blister

CÓDIGO	PRECIO	INNER	MASTER
TPCCT612	\$ 33.50	12	72

**Probador de corriente digital**

Medición individual para AC/DC

12 - 200 V ~

Punta desarmador



**NOM** Blister Doble

CÓDIGO	PRECIO	INNER	MASTER
STPC1138	\$ 35.00	12	72

**Probador de voltaje 4 vías**

CD/CA

Rango de medición

110 V ~  
220 V ~  
277 V ~  
460 V ~



**NOM** Blister

CÓDIGO	PRECIO	INNER	MASTER
TPVT460	\$ 42.00	12	96

**Multímetro digital 7 funciones**

Incluye puntas

Tensión CA 200 V - 750 V~

Corriente CC 200 mA 10 A

Mide: voltaje CD y CA temperatura resistencia

Indica polaridad

Usa baterías 9 V (incluida)

Tensión CC 200 mV a 1000 V~



**NOM** Blister

CÓDIGO	PRECIO	INNER	MASTER
TPMTESTER	\$ 145.00	6	72

**Multímetro digital gancho 3 puntas profesional**

Mide voltaje CD/CA, temperatura, y resistencia

Pantalla digital LCD de 3 1/2"

Indicador de polaridad

Botón de congelamiento de pantalla

Opera con 1 batería de 9 V (incluida)



Caja a color

CÓDIGO	PRECIO	INNER	MASTER
STMD1114	\$ 420.00	5	20

**Juego de cautín tipo lápiz con accesorios**

127 V ~  
60 Hz  
30 W

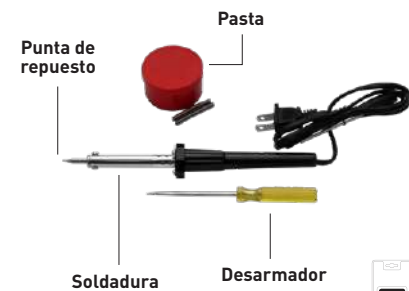

**NOM** Blister

CÓDIGO	PRECIO	INNER	MASTER
TPC388	\$ 88.00	10	50

**Pila alcalina AA 4 piezas**

Misma duración que las marcas mas reconocidas

Ideal para cámaras digitales, reproductores, juegos de video, juguetes de control remoto, etc.



**NOM** Blister

CÓDIGO	PRECIO	INNER	MASTER
STPA1148	\$ 33.00	10	120

**Calentador de inmersión**

77 cm de largo

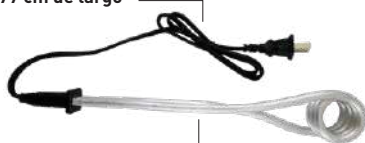

Cuerpo de aluminio



**NOM** Bolsa Cabezal

CÓDIGO	DESC.	PRECIO	INNER	MASTER
TPEWH2	300 W 2 L	\$ 25.00	10	200
TPEWH5	500 W 5 L	\$ 30.00	10	200
TPEWH15	800 W 15 L	\$ 37.00	10	100
TPEWH20	1000 W 20 L	\$ 40.00	10	100

**Interruptor termomagnético 1 polo**

Protege contra sobrecargas y cortos circuitos



240 V ~  
120 V ~  
60 Hz  
600 W  
10 kA  
40 °C

**NOM** Caja a color

CÓDIGO	DESC.	PRECIO	INNER	MASTER
IT1P15A	15 Amperes	\$ 55.00	10	200
IT1P20A	20 Amperes	\$ 55.00	10	200
IT1P30A	30 Amperes	\$ 55.00	10	200
IT1P40A	40 Amperes	\$ 55.00	10	200
IT1P50A	50 Amperes	\$ 55.00	10	200

**Pila alcalina AAA 4 piezas**

Misma duración que las marcas mas reconocidas

Ideal para cámaras digitales, reproductores, juegos de video, juguetes de control remoto, etc.



**NOM** Blister

CÓDIGO	PRECIO	INNER	MASTER
STPA1149	\$ 28.00	10	120

El aspecto, empaque, inner o master de los productos puede variar sin previo aviso debido a la innovación continua de nuestras marcas.



**Luminario de LED dirigible**

Para empotrar  
COB de alta potencia

- Luz fría
- Luz cálida



**Luminario de LED fijo**

Para empotrar  
COB de alta potencia

- Luz fría
- Luz cálida

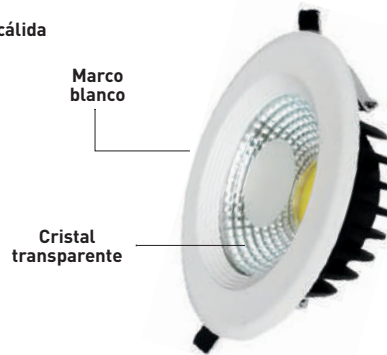

120° GRADOS DE ILUMINACIÓN		COB	Hrs 20000	NOM	Caja a color	
LUZ FRÍA	LUZ CÁLIDA	DESCRIPCIÓN	PRECIO	INNER	MASTER	
ST2273	ST2272	5 W, 350 lm	\$ 170.00	1	50	
ST2275	ST2274	7 W, 490 lm	\$ 200.00	1	50	
ST2277	ST2276	9 W, 630 lm	\$ 250.00	1	50	
ST2279	ST2278	12 W, 840 lm	\$ 360.00	1	50	

120° GRADOS DE ILUMINACIÓN		COB	Hrs 20000	NOM	Caja a color	
LUZ FRÍA	LUZ CÁLIDA	DESCRIPCIÓN	PRECIO	INNER	MASTER	
ST2281	ST2280	3 W, 210 lm	\$ 130.00	1	50	
ST2283	ST2282	5 W, 350 lm	\$ 155.00	1	50	
ST2285	ST2284	10 W, 700 lm	\$ 240.00	1	50	
ST2287	ST2286	15 W, 1050 lm	\$ 320.00	1	40	

**Luminario de LEDs**

Para empotrar

- Luz fría
- Luz cálida

Producto  
**NUEVO**



**Luminario de LEDs dirigible**

Para empotrar

- Luz fría
- Luz cálida



120° GRADOS DE ILUMINACIÓN		Hrs 20000	NOM	Caja a color	
LUZ FRÍA	LUZ CÁLIDA	DESCRIPCIÓN	PRECIO	INNER	MASTER
ST2290	ST2295	3 W, 210 lm, 6 LEDs en línea	\$ 65.00	1	100
ST2291	ST2296	5 W, 350 lm, 10 LEDs en línea	\$ 80.00	1	100
ST2292	ST2297	7 W, 490 lm, 16 LEDs en línea	\$ 90.00	1	100
ST2293	ST2298	9 W, 630 lm, 22 LEDs en línea	\$ 175.00	1	100
ST2294	ST2299	12 W, 840 lm, 30 LEDs en línea	\$ 185.00	1	100

120° GRADOS DE ILUMINACIÓN		Hrs 20000	NOM	Caja a color	
LUZ FRÍA	LUZ CÁLIDA	DESCRIPCIÓN	PRECIO	INNER	MASTER
ST2301	ST2300	3 W, 210 lm, 6 LEDs en línea	\$ 55.00	1	100
ST2303	ST2302	5 W, 350 lm, 10 LEDs en línea	\$ 85.00	1	100
ST2305	ST2304	7 W, 490 lm, 16 LEDs en línea	\$ 105.00	1	100
ST2307	ST2306	9 W, 630 lm, 22 LEDs en línea	\$ 155.00	1	100
ST2309	ST2308	12 W, 840 lm, 30 LEDs en línea	\$ 160.00	1	100

**Luminario de LEDS fijo**

Para empotrar

- Luz fría
- Luz cálida

Producto NUEVO

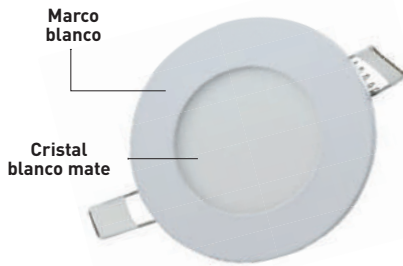

**Luminario de LEDS fijo**

Para empotrar

- Luz fría
- Luz cálida

Producto NUEVO

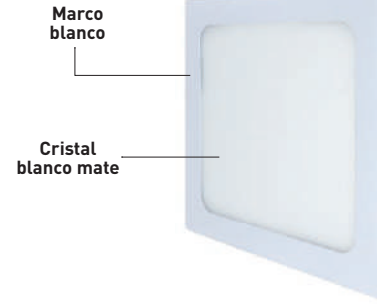

LUZ FRÍA	LUZ CÁLIDA	DESCRIPCIÓN	PRECIO	INNER	MASTER
ST2331	ST2340	3 W, 210 lm, 15 LEDS en línea	\$ 40.00	1	100
ST2333	ST2341	6 W, 420 lm, 30 LEDS en línea	\$ 65.00	1	100
ST2335	ST2342	9 W, 630 lm, 45 LEDS en línea	\$ 95.00	1	100
ST2337	ST2343	12 W, 840 lm, 60 LEDS en línea	\$ 105.00	1	100
ST2339	ST2344	15 w,1050 lm, 75 LEDS en línea	\$ 110.00	1	100

LUZ FRÍA	LUZ CÁLIDA	DESCRIPCIÓN	PRECIO	INNER	MASTER
ST2345	ST2350	3 W, 210 lm, 15 LEDS en línea	\$ 45.00	1	100
ST2346	ST2351	6 W, 420 lm, 30 LEDS en línea	\$ 65.00	1	100
ST2347	ST2352	9 W, 630 lm, 45 LEDS en línea	\$ 100.00	1	100
ST2348	ST2353	12 W, 840 lm, 60 LEDS en línea	\$ 110.00	1	100
ST2349	ST2354	15 w,1050 lm, 75 LEDS en línea	\$ 120.00	1	100

**Luminario de LEDS fijo**

De sobreponer

- Luz fría
- Luz cálida

Producto NUEVO

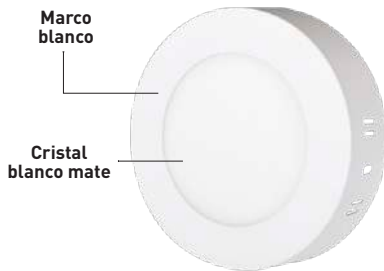

**Luminario de LEDS fijo**

De sobreponer

- Luz fría
- Luz cálida

Producto NUEVO



LUZ FRÍA	LUZ CÁLIDA	DESCRIPCIÓN	PRECIO	INNER	MASTER
ST2355	ST2359	6 W, 420 lm, 30 LEDS en línea	\$ 115.00	1	40
ST2356	ST2360	12 W, 840 lm, 60 LEDS en línea	\$ 160.00	1	20

LUZ FRÍA	LUZ CÁLIDA	DESCRIPCIÓN	PRECIO	INNER	MASTER
ST2357	ST2361	6 W, 420 lm, 30 LEDS en línea	\$ 115.00	1	40
ST2358	ST2362	12 W, 840 lm, 60 LEDS en línea	\$ 160.00	1	20

**Luminario de LEDS fijo**

Para empotrar

- Luz fría
- Luz cálida

Producto NUEVO

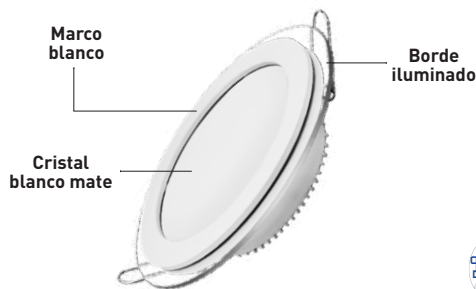

**Luminario de LEDS fijo**

Para empotrar

- Luz fría
- Luz cálida

Producto NUEVO

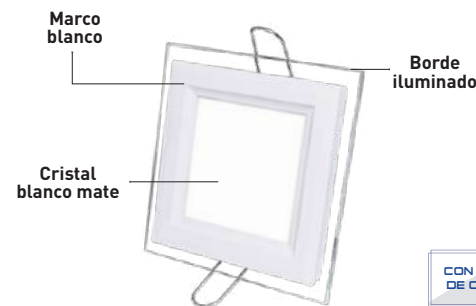

LUZ FRÍA	LUZ CÁLIDA	DESCRIPCIÓN	PRECIO	INNER	MASTER
ST2365	ST2370	3 W, 210 lm, 6 LEDS en línea	\$ 80.00	1	100
ST2366	ST2371	6 W, 420 lm, 12 LEDS en línea	\$ 125.00	1	100
ST2367	ST2372	9 W, 630 lm, 18 LEDS en línea	\$ 150.00	1	60
ST2368	ST2373	12 W, 840 lm, 24 LEDS en línea	\$ 200.00	1	50
ST2369	ST2374	15 W, 1050 lm, 30 LEDS en línea	\$ 220.00	1	50

LUZ FRÍA	LUZ CÁLIDA	DESCRIPCIÓN	PRECIO	INNER	MASTER
ST2375	ST2380	3 W, 210 lm, 6 LEDS en línea	\$ 90.00	1	100
ST2376	ST2381	6 W, 420 lm, 12 LEDS en línea	\$ 135.00	1	100
ST2377	ST2382	9 W, 630 lm, 18 LEDS en línea	\$ 160.00	1	60
ST2378	ST2383	12 W, 840 lm, 24 LEDS en línea	\$ 200.00	1	50
ST2379	ST2384	15 W, 1050 lm, 30 LEDS en línea	\$ 240.00	1	50

El aspecto, empaque, inner o master de los productos puede variar sin previo aviso debido a la innovación continua de nuestras marcas.

CON MARCO DE CRISTAL

CON MARCO DE CRISTAL

## Luminario de LED dirigible

Para empotrar  
COB de alta potencia

- Luz fría
- Luz cálida



120° GRADOS DE ILUMINACIÓN		COB	Hrs 20000	NOM	Caja a color
LUZ FRÍA	LUZ CÁLIDA	DESCRIPCIÓN	INNER	MASTER	
ST2491	ST2490	3 W, 210 lm	1	100	
ST2493	ST2492	5 W, 350 lm	1	100	
ST2495	ST2494	10 W, 700 lm	1	100	
ST2497	ST2496	15 W, 1050 lm	1	100	



## Luminario spot LED para piso

Para empotrar

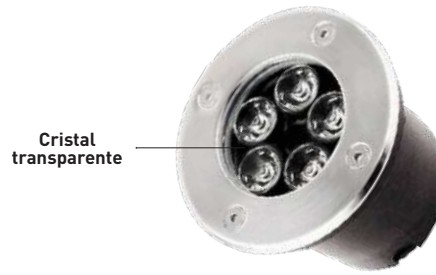

120° GRADOS DE ILUMINACIÓN		Hrs 20000	NOM	Caja a color
CÓDIGO	DESCRIPCIÓN	INNER	MASTER	
ST2480	5 W, 350 lm, luz cálida	1	100	
ST2481	5 W, 350 lm, luz fría	1	100	



## Luminario de LED fijo

Para empotrar  
Tipo campana



120° GRADOS DE ILUMINACIÓN		Hrs 20000	NOM	Caja a color
CÓDIGO	DESCRIPCIÓN	INNER	MASTER	
ST2470	7.5 W, 525 lm, luz blanca, marco blanco	1	100	
ST2471	7.5 W, 525 lm, luz fría, marco blanco	1	100	
ST2472	7.5 W, 525 lm, luz blanca, marco plata	1	100	
ST2473	7.5 W, 525 lm, luz fría, marco plata	1	100	



## Juego de accesorios para suspensión de panel LED



120° GRADOS DE ILUMINACIÓN		Hrs 20000	NOM	Caja a color
CÓDIGO	DESCRIPCIÓN	PRECIO	INN.	MAS.
ST2410	Juego de accesorios para panel LED, cables de acero	\$ 160.00	1	125

1m  
Altura de suspensión

## Panel de LEDs de ultraplano 1200 mm x 600 mm

Para empotrar o suspender  
Juego de accesorios para suspensión no incluido



120° GRADOS DE ILUMINACIÓN		Hrs 20000	NOM	Caja a color
CÓDIGO	DESCRIPCIÓN	PRECIO	INN.	MAS.
ST2315	56 W, 3920 lm, 280 LEDs en línea, luz blanca	\$ 1,800.00	1	6
ST2316	56 W, 3920 lm, 280 LEDs en línea, luz fría	\$ 1,800.00	1	6
ST2317	72 W, 5040 lm, 360 LEDs en línea, luz blanca	\$ 2,240.00	1	6
ST2318	72 W, 5040 lm, 360 LEDs en línea, luz fría	\$ 2,240.00	1	6

## Panel de LEDs de ultraplano 600 mm x 600 mm

Para empotrar o suspender  
Juego de accesorios para suspensión no incluido

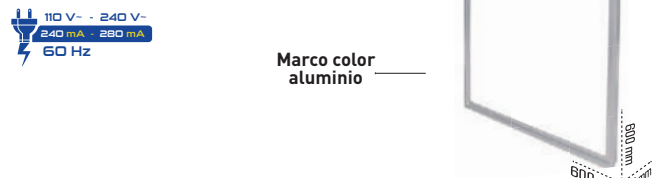

120° GRADOS DE ILUMINACIÓN		Hrs 20000	NOM	Caja a color
CÓDIGO	DESCRIPCIÓN	PRECIO	INN.	MAS.
ST2319	36 W, 2520 lm, 180 LEDs en línea, luz blanca	\$ 990.00	1	10
ST2320	36 W, 2520 lm, 180 LEDs en línea, luz fría	\$ 990.00	1	10
ST2321	48 W, 3360 lm, 240 LEDs en línea, luz blanca	\$ 1,210.00	1	10
ST2322	48 W, 3360 lm, 240 LEDs en línea, luz fría	\$ 1,210.00	1	10

**Reflector LED**

Delgado



CÓDIGO	DESCRIPCIÓN	INNER	MASTER
ST2690	10 W, 700 lm	1	100
ST2691	20 W, 1400 lm	1	100
ST2692	30 W, 2100 lm	1	100
ST2693	50 W, 3500 lm	1	100
ST2694	100 W, 7000 lm	1	100

**Reflector LED antivandálico**

Lente de policarbonato



100 W



150 W



CÓDIGO	DESCRIPCIÓN	INNER	MASTER
ST2684	100 W, 700 lm	1	100
ST2685	150 W, 10500 lm	1	100

**Luminario de LED con rejilla 1240 mm de largo**

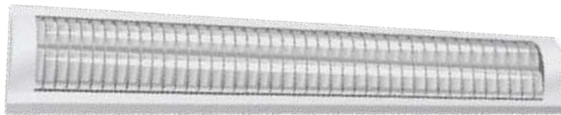

CÓDIGO	DESCRIPCIÓN	INNER	MASTER
ST2485	2 x 17 W, 2380 lm, luz cálida	1	100
ST2486	2 x 17 W, 2380 lm, luz fría	1	100

**Gabinete panel rectangular LED 1240 mm de largo**



CÓDIGO	DESCRIPCIÓN	INNER	MASTER
ST2590	2 x 17 W, 2380 lm, luz cálida	1	100
ST2591	2 x 17 W, 2380 lm, luz fría	1	100

**Luminario de LED a prueba de vapor 1240 mm de largo**



CÓDIGO	DESCRIPCIÓN	INNER	MASTER
ST2465	2 x 17 W, 2380 lm, luz fría	1	100

**Luminario de LEDs con interruptor**



Inteconectable



CÓDIGO	DESCRIPCIÓN	INNER	MASTER
ST2680	6 W, 420 lm, 300 mm	1	100
ST2681	11 W, 770 lm, 600 mm	1	100
ST2682	19 W, 1330 lm, 900 mm	1	100
ST2683	24 W, 1680 lm, 1200 mm	1	100

**Luminario de LED fijo tipo Campana**



CÓDIGO	DESCRIPCIÓN	INNER	MASTER
ST2460	30 W, 2100 lm	1	100

**Tira de LED para iluminación 300 LEDs**

Uso interior y exterior

Incluye adaptador



CÓDIGO	DESCRIPCIÓN	INNER	MASTER
ST2696	Luz cálida	1	100
ST2697	Luz fría	1	100
ST2698	Multicolores	1	100

El aspecto, empaque, inner o master de los productos puede variar sin previo aviso debido a la innovación continua de nuestras marcas.



## Tubo de LEDs cristal blanco mate

82% Ahorro de energía  
Hasta 4 m altura de instalación



CÓDIGO	DESCRIPCIÓN	PRECIO	INNER	MASTER
ST2240	9 W, 630 lm, 600 mm	\$ 89.00	1	50
ST2241	18 W, 1260 lm, 1200 mm	\$ 115.00	1	50

## Tubo de LEDs cristal blanco mate

82% Ahorro de energía  
Hasta 4 m altura de instalación



CÓDIGO	DESCRIPCIÓN	PRECIO	INNER	MASTER
ST2245	6 W, 420 lm, 300 mm	\$ 93.00	1	50
ST2246	8 W, 560 lm, 600 mm	\$ 103.00	1	50
ST2247	10 W, 700 lm, 600 mm	\$ 118.00	1	50

## Tubo de LEDs cristal transparente

82% Ahorro de energía  
Hasta 4 m altura de instalación



CÓDIGO	DESCRIPCIÓN	PRECIO	INNER	MASTER
ST2264	9 W, 630 lm, 600 mm	\$ 173.00	1	50
ST2265	18 W, 1260 lm, 1200 mm	\$ 149.00	1	50

## Tubo de LEDs cristal transparente

82% Ahorro de energía  
Hasta 4 m altura de instalación



CÓDIGO	DESCRIPCIÓN	PRECIO	INNER	MASTER
ST2266	9 W, 630 lm, 600 mm	\$ 146.00	1	50
ST2267	18 W, 1260 lm, 1200 mm	\$ 163.00	1	50

## Base para tubo LED aluminio

Acabado color blanco



CÓDIGO	DESCRIPCIÓN	PRECIO	INNER	MASTER
ST2408	600 mm, T5	\$ 237.00	1	50
ST2409	600 mm, T8	\$ 237.00	1	50
ST2417	1200 mm, T5	\$ 290.00	1	10
ST2418	1200 mm, T8	\$ 290.00	1	10

## Base para tubo LED metálica

Acabado color blanco



CÓDIGO	DESCRIPCIÓN	PRECIO	INNER	MASTER
ST2406	600 mm, T5	\$ 195.00	1	50
ST2407	600 mm, T8	\$ 195.00	1	50
ST2415	1200 mm, T5	\$ 243.00	1	10
ST2416	1200 mm, T8	\$ 243.00	1	10

## Luminario de LEDs

82% Ahorro de energía  
Hasta 4 m altura de instalación



CÓDIGO	DESCRIPCIÓN	PRECIO	INNER	MASTER
ST2260	6 W, 420 lm, 600 mm	\$ 115.00	1	50
ST2261	12 W, 840 lm, 1200 mm	\$ 180.00	1	50

## Terminal para tubo LED de 2 polos



CÓDIGO	DESCRIPCIÓN	PRECIO	INNER	MASTER
ST2401	T5, Base metálica	\$ 6.50	500	1500
ST2412	T8, Base metálica	\$ 6.50	500	1500
ST2413	T5, Base aluminio	\$ 6.50	500	1500
ST2414	T8, Base aluminio	\$ 6.50	500	1500

**Foco led tipo bulbo**

3 años de garantía

Consumo 85% menos energía que un foco incandescente



**Foco ahorrador recto 2U**



Diámetro de tubo tipo T4



FLUJO LUMINOSO	EQUIVALENCIA
3 W = 210 lm	3 W = 30 W
5 W = 350 lm	5 W = 40 W
9 W = 630 lm	9 W = 60 W
12 W = 840 lm	12 W = 80 W



FLUJO LUMINOSO	EQUIVALENCIA
13 W = 676 lm	13 W = 40 W



BLISTER	PRECIO	CAJA	PRECIO	MASTER
STFL1708	\$ 28.00	ST2450	\$ 26.00	100
STFL1709	\$ 36.00	ST2451	\$ 34.00	100
STFL1710	\$ 49.00	ST2452	\$ 43.00	50
STFL1711	\$ 55.00	ST2453	\$ 53.00	50

BLISTER	PRECIO	CAJA	PRECIO	MASTER
TPFA780	\$ 29.00	ST2405	\$ 27.00	50

**Foco ahorrador recto 3U**



Diámetro de tubo tipo T4



**Foco ahorrador espiral**



Diámetro de tubo tipo T4



FLUJO LUMINOSO	EQUIVALENCIA
20 W = 1040 lm	20 W = 75 W
25 W = 1300 lm	25 W = 100 W



FLUJO LUMINOSO	EQUIVALENCIA
20 W = 1040 lm	20 W = 75 W
25 W = 1300 lm	25 W = 100 W



BLISTER	PRECIO	MASTER	CAJA	PRECIO	MASTER
TPFA781	\$ 40.00	100	ST2402	\$ 37.00	50
TPFA782	\$ 44.00	100	ST2403	\$ 42.00	50

BLISTER	PRECIO	CAJA	PRECIO	MASTER
TPFA783	\$ 44.00	ST2404	\$ 42.00	50
TPFA784	\$ 52.00	ST2411	\$ 50.00	50

**Foco ahorrador espiral**



Diámetro de tubo tipo T4



**Foco halógeno tipo bulbo**



Vidrio claro

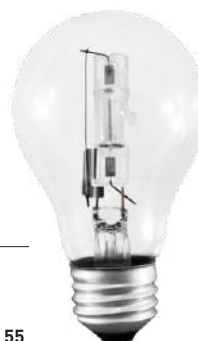

Tipo A 55

FLUJO LUMINOSO	EQUIVALENCIA
25 W = 1300 lm	25 W = 100 W



FLUJO LUMINOSO	EQUIVALENCIA
72 W = 100 W	



BLISTER	PRECIO	CAJA	PRECIO	MASTER
TPFA785	\$ 56.00	ST2400	\$ 59.00	50

CÓDIGO	PRECIO	EQUIVALENCIA	MASTER
STFH1816	\$ 12.60	72 W = 100 W	100

## Porta lámpara porcelana 4 1/2"



Casquillo de latón



CÓDIGO	PRECIO	INNER	MASTER
TP1036	\$ 18.00	1	60

## Socket para intemperie reforzado



Cuerpo de PVC

Calibre 16



CÓDIGO	PRECIO	INNER	MASTER
TP1035	\$ 14.50	30	300

## Contacto industrial aterrizado con abrazadera



Cuerpo de ABS y PVC



CÓDIGO	PRECIO	INNER	MASTER
TP1013	\$ 17.00	10	300

## Caja octagonal Cal.22



CÓDIGO	DESC.	PRECIO	INNER	MASTER
STC01654	3" X 3", entrada de 1/2"	\$ 9.00	1	250
STC01655	4" X 4", entradas de 1/2" y 3/4"	\$ 14.00	1	200

## Socket ladrón sencillo

Para intemperie



Cuerpo de baquelita

Contactos polarizados



CÓDIGO	PRECIO	INNER	MASTER
TP1033	\$ 13.00	12	600

## Socket portalámpara sencillo

Cuerpo de baquelita



CÓDIGO	PRECIO	INNER	MASTER
TP1038	\$ 8.00	20	600

## Porta lámpara porcelana tipo anuncio

De sobreponer



Casquillo de latón

Soporta hasta 350 °C



CÓDIGO	PRECIO	INNER	MASTER
TP1037	\$ 9.00	1	240

## Multicontacto triple aterrizado



Cuerpo de ABS y PVC



CÓDIGO	PRECIO	INNER	MASTER
MTA802	\$ 45.00	10	120

## Caja cuadrada Cal.22



CÓDIGO	DESC.	PRECIO	INNER	MASTER
STCC1656	3" X 3", entrada de 1/2"	\$ 8.00	1	200
STCC1657	4" X 4", entradas de 1/2" y 3/4"	\$ 14.00	1	100

## Socket ladrón con cadena

Para intemperie



Cuerpo de baquelita

Contactos polarizados



CÓDIGO	PRECIO	INNER	MASTER
TP1032	\$ 19.00	12	600

## Socket para intemperie sencillo



Cuerpo de PVC

Calibre 18



CÓDIGO	PRECIO	INNER	MASTER
TP1034	\$ 11.00	36	432

## Clavija aterrizada con abrazadera



Cuerpo de ABS y PVC



CÓDIGO	PRECIO	INNER	MASTER
TP1025	\$ 14.50	10	300

## Convertidor a tierra



Cuerpo de ABS



CÓDIGO	PRECIO	INNER	MASTER
TP1024	\$ 6.50	30	600

## Chalupa 2" X 4" Cal. 22



Entrada 1/2" y 3/4"



CÓDIGO	PRECIO	INNER	MASTER
STCH1658	\$ 7.50	1	250

**Interruptor sencillo**



Cuerpo de ABS

**NOM**

Línea Eco



CÓDIGO	PRECIO	INNER	MASTER
TP1010	\$ 7.50	50	1000

**Interruptor tres vías escalera**



Cuerpo de ABS

**NOM**

Línea Eco



CÓDIGO	PRECIO	INNER	MASTER
TP1023	\$ 9.00	50	1000

**Botón para timbre**



Cuerpo de ABS

**NOM**

Línea Eco



CÓDIGO	PRECIO	INNER	MASTER
TP1012	\$ 6.50	50	1000

**Interruptor sencillo fluorescente**



Cuerpo de ABS

**NOM**

Línea Eco



CÓDIGO	PRECIO	INNER	MASTER
TP1011	\$ 8.00	50	1000

**Contacto sencillo polarizado**



Cuerpo de ABS

**NOM**

Línea Eco



CÓDIGO	PRECIO	INNER	MASTER
TP1014	\$ 7.00	50	1000

**Interruptor visible tipo huevo**



Cuerpo de ABS

**NOM**

CÓDIGO	PRECIO	INNER	MASTER
TP1021	\$ 10.00	12	600

**Placa dúplex**

Cuerpo de ABS

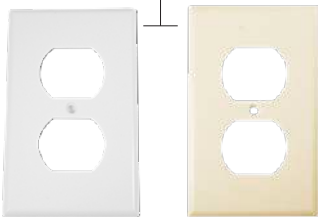

Línea Standard



CÓDIGO	DESC.	PRECIO	INN.	MAS.
TP1031	Beige	\$ 6.00	30	600
TP1031W	Blanco	\$ 6.00	30	600

**Placa vertical sencilla**

Cuerpo de ABS



Línea Standard



CÓDIGO	DESC.	PRECIO	INN.	MAS.
TP1030	Beige	\$ 7.00	30	600
TP1030W	Blanco	\$ 7.00	30	600

**Placa dúplex naranja Grado hospital**

Cuerpo de ABS



Línea Standard



CÓDIGO	PRECIO	INNER	MASTER
TP1041	\$ 8.00	30	600

**Placa dúplex**

Cuerpo metálico



Línea Standard



CÓDIGO	PRECIO	INNER	MASTER
TP1042	\$ 17.00	30	300

**Placa metálica Incluye chasis**

Cuerpo metálico

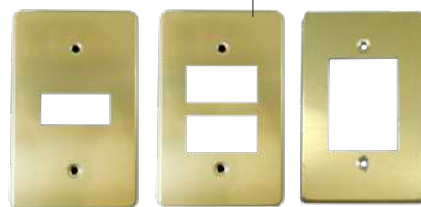

Línea Eco



CÓDIGO	DESC.	PRECIO	INNER	MASTER
TP1027	1 Módulo	\$ 17.00	30	300
TP1028	2 Módulo	\$ 17.00	30	300
TP1029	3 Módulo	\$ 17.00	30	300

**Placa dúplex para intemperie**

Cuerpo de ABS



Línea Standard



CÓDIGO	PRECIO	INNER	MASTER
TP1043	\$ 21.00	10	500

## Interruptor vertical sencillo

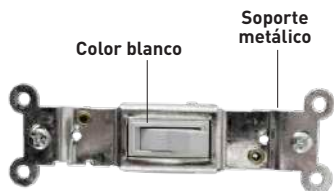

**NOM** Línea Standard Bolsa Impresa

CÓDIGO	PRECIO	INNER	MASTER
TP1015W	\$ 16.00	10	200

## Interruptor vertical sencillo beige



**NOM** Línea Standard Bolsa Impresa

CÓDIGO	PRECIO	INNER	MASTER
TP1015	\$ 16.00	10	200

## Contacto aterrizado dúplex



**NOM** Línea Standard Bolsa Impresa

CÓDIGO	DESC.	PRECIO	INNER	MASTER
TP1017	Beige	\$ 14.00	10	200
TP1017W	Blanco	\$ 14.00	10	200

## Contacto aterrizado dúplex

Especial para uso de maquinaria y grado hospital



**NOM** Línea Standard Bolsa Impresa

CÓDIGO	PRECIO	INNER	MASTER
TP1022	\$ 40.00	10	200

## Interruptor con contacto aterrizado

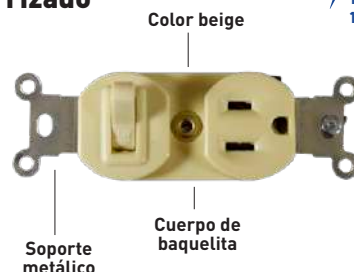

**NOM** Línea Standard Bolsa Impresa

CÓDIGO	PRECIO	INNER	MASTER
TP1020	\$ 30.00	10	200

## Interruptor con contacto aterrizado

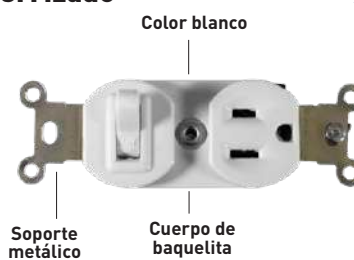

**NOM** Línea Standard Bolsa Impresa

CÓDIGO	PRECIO	INNER	MASTER
TP1020W	\$ 30.00	10	200

## Interruptor con contacto polarizado



**NOM** Línea Standard Bolsa Impresa

CÓDIGO	PRECIO	INNER	MASTER
TP1019W	\$ 27.00	10	200

## Interruptor con contacto polarizado

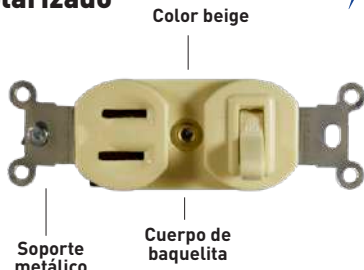

**NOM** Línea Standard Bolsa Impresa

CÓDIGO	PRECIO	INNER	MASTER
TP1019	\$ 27.00	10	200

## Contacto aterrizado de superficie dúplex



**NOM** Línea Standard Bolsa Impresa

CÓDIGO	PRECIO	INNER	MASTER
TP1016	\$ 17.50	10	200

## Interruptor doble

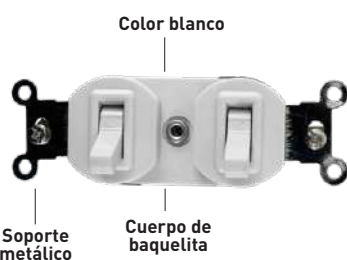

**NOM** Línea Standard Bolsa Impresa

CÓDIGO	PRECIO	INNER	MASTER
TP1018W	\$ 26.00	10	200

## Interruptor doble

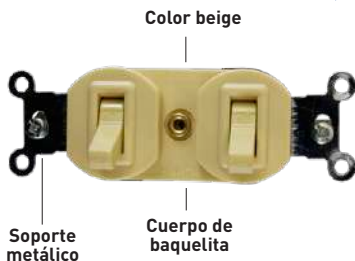

**NOM** Línea Standard Bolsa Impresa

CÓDIGO	PRECIO	INNER	MASTER
TP1018	\$ 26.00	10	200

## Multicontacto 6 salidas UL



CÓDIGO	PRECIO	INNER	MASTER
TPPOWER6UL	\$ 82.00	1	50

**Interruptor sencillo**



Color beige  
Cuerpo de ABS

**Interruptor escalera**



Color beige  
Cuerpo de ABS

**Botón timbre**



Color beige  
Cuerpo de ABS

Línea 300



CÓDIGO	PRECIO	INNER	MASTER
ASA803	\$ 11.00	20	1000

Línea 300



CÓDIGO	PRECIO	INNER	MASTER
AEA807	\$ 13.00	20	1000

Línea 300



CÓDIGO	PRECIO	INNER	MASTER
BTA805	\$ 14.00	20	1000

**Contacto aterrizado**



Cuerpo de ABS  
Color beige

**Contacto polarizado**



Color beige  
Cuerpo de ABS

**Contacto aterrizado dúplex**



Color beige  
Cuerpo de ABS

Línea 300



CÓDIGO	PRECIO	INNER	MASTER
TAA804	\$ 14.00	20	1000

Línea 300



CÓDIGO	PRECIO	INNER	MASTER
TPA806	\$ 13.00	20	1000

Línea 300



CÓDIGO	PRECIO	INNER	MASTER
TDA808	\$ 21.00	20	600

**Toma para televisión**



Color beige  
Cuerpo de ABS

**Toma para teléfono 4 hilos**



Color beige  
Cuerpo de ABS

**Placa sencilla**



Color beige  
Cuerpo de ABS

Línea 300



CÓDIGO	PRECIO	INNER	MASTER
TTA809	\$ 14.00	20	1000

Línea 300



CÓDIGO	PRECIO	INNER	MASTER
TTA810	\$ 16.00	20	800

Línea 300



CÓDIGO	PRECIO	INNER	MASTER
PSA811	\$ 14.00	20	800

**Placa doble**



Color beige  
Cuerpo de ABS

**Placa triple**



Color beige  
Cuerpo de ABS

**Placa abierta**



Color beige  
Cuerpo de ABS

Línea 300



CÓDIGO	PRECIO	INNER	MASTER
PDA812	\$ 14.00	20	200

Línea 300



CÓDIGO	PRECIO	INNER	MASTER
PTA813	\$ 15.00	20	200

Línea 300



CÓDIGO	PRECIO	INNER	MASTER
PAA814	\$ 14.00	20	200

El aspecto, empaque, inner o master de los productos puede variar sin previo aviso debido a la innovación continua de nuestras marcas.

## Interruptor sencillo

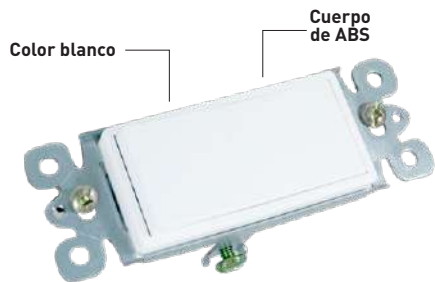

Línea 600

<b>CÓDIGO</b>	<b>PRECIO</b>	<b>INNER</b>	<b>MASTER</b>
ASA821	\$ 32.00	20	200

## Interruptor doble

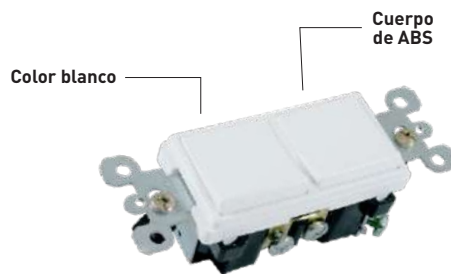

Línea 600

<b>CÓDIGO</b>	<b>PRECIO</b>	<b>INNER</b>	<b>MASTER</b>
ADA820	\$ 52.00	20	200

## Interruptor triple

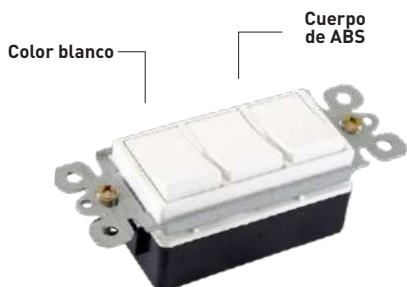

Línea 600

<b>CÓDIGO</b>	<b>PRECIO</b>	<b>INNER</b>	<b>MASTER</b>
ATA819	\$ 57.00	20	200

## Contacto aterrizado dúplex

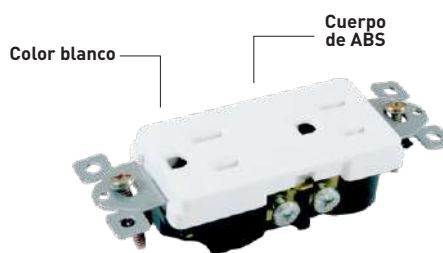

Línea 600

<b>CÓDIGO</b>	<b>PRECIO</b>	<b>INNER</b>	<b>MASTER</b>
TDA822	\$ 25.50	20	200

## Toma para televisión

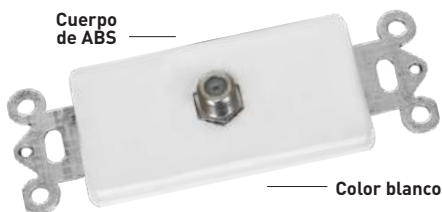

Línea 600

<b>CÓDIGO</b>	<b>PRECIO</b>	<b>INNER</b>	<b>MASTER</b>
TTA815	\$ 27.00	20	200

## Toma para teléfono 4 hilos

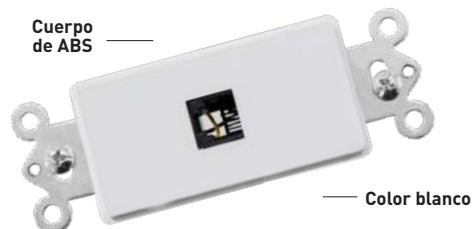

Línea 600

<b>CÓDIGO</b>	<b>PRECIO</b>	<b>INNER</b>	<b>MASTER</b>
TTA816	\$ 27.00	20	200

## Placa ciega

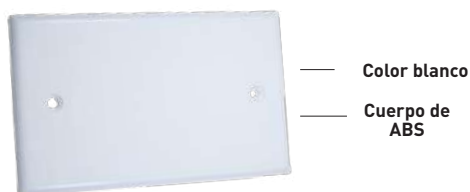

Línea 600

<b>CÓDIGO</b>	<b>PRECIO</b>	<b>INNER</b>	<b>MASTER</b>
PCA817	\$ 7.50	30	600

## Placa sencilla

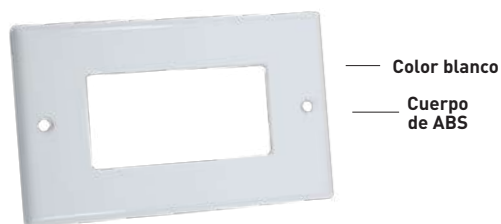

Línea 600

<b>CÓDIGO</b>	<b>PRECIO</b>	<b>INNER</b>	<b>MASTER</b>
PSA818	\$ 5.00	30	600

**Contacto sencillo aterrizado**



Color negro  
Cuerpo de ABS

Línea 900



CÓDIGO	PRECIO	INNER	MASTER
STTS1297	\$ 22.00	20	600

**Contacto sencillo aterrizado**



Color gris  
Cuerpo de ABS

Línea 900



CÓDIGO	PRECIO	INNER	MASTER
STTS1298	\$ 22.00	20	600

**Interruptor**



Color negro  
Cuerpo de ABS

Línea 900



CÓDIGO	DESC.	PRECIO	INNER	MASTER
STAS1295	2 Vías	\$ 19.00	20	600
STAE1812	3 Vías	\$ 23.00	20	600

**Interruptor**



Color gris  
Cuerpo de ABS

Línea 900



CÓDIGO	DESC.	PRECIO	INNER	MASTER
STAS1296	2 Vías	\$ 19.00	20	600
STAE1813	3 Vías	\$ 23.00	20	600

**Contacto aterrizado dúplex**

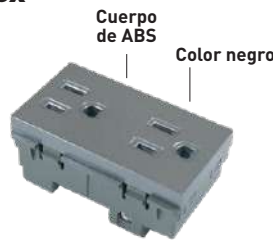

Cuerpo de ABS  
Color negro

Línea 900



CÓDIGO	PRECIO	INNER	MASTER
STTD1299	\$ 39.00	10	300

**Contacto aterrizado dúplex**



Cuerpo de ABS  
Color gris

Línea 900



CÓDIGO	PRECIO	INNER	MASTER
STTD1300	\$ 39.00	10	300

**Interruptor sencillo**



Color negro  
Cuerpo de ABS

Línea 900



CÓDIGO	PRECIO	INNER	MASTER
STAS1302	\$ 26.00	20	300

**Interruptor sencillo**



Color gris  
Cuerpo de ABS

Línea 900



CÓDIGO	PRECIO	INNER	MASTER
STAS1303	\$ 26.00	20	300

**Botón timbre**



Color negro  
Cuerpo de ABS

Línea 900



CÓDIGO	PRECIO	INNER	MASTER
STBT1304	\$ 29.00	20	300

**Botón timbre**



Color gris  
Cuerpo de ABS

Línea 900



CÓDIGO	PRECIO	INNER	MASTER
STBT1305	\$ 29.00	20	300

**Interruptor triple**



Color negro  
Cuerpo de ABS

Línea 900



CÓDIGO	PRECIO	INNER	MASTER
STAT1306	\$ 47.00	10	300

**Interruptor triple**



Color gris  
Cuerpo de ABS

Línea 900



CÓDIGO	PRECIO	INNER	MASTER
STAT1307	\$ 47.00	10	300

El aspecto, empaque, inner o master de los productos puede variar sin previo aviso debido a la innovación continua de nuestras marcas.



## Placa abierta

Incluye chasis

Cuerpo de acero inoxidable



Línea 900



CÓDIGO	PRECIO	INNER	MASTER
STPA1301	\$ 35.50	20	300

## Modulo ciego 18 mm (2 Piezas)

Color negro



Cuerpo de ABS

Línea 900



CÓDIGO	DESC.	PRECIO	INNER	MASTER
STPC1314	Negra	\$ 8.50	30	600

## Modulo ciego 18 mm (2 Piezas)

Color gris



Cuerpo de ABS

Línea 900



CÓDIGO	DESC.	PRECIO	INNER	MASTER
STPC1315	Gris	\$ 8.50	30	600

## Toma TV coaxial 36 mm



Color negro

Cuerpo de ABS

Línea 900



CÓDIGO	PRECIO	INNER	MASTER
STTT1312	\$ 29.00	20	600

## Toma TV coaxial 36 mm



Color gris

Cuerpo de ABS

Línea 900



CÓDIGO	PRECIO	INNER	MASTER
STTT1313	\$ 29.00	20	600

## Toma para teléfono 36 mm

4 Hilos



Color negro

Cuerpo de ABS

Línea 900



CÓDIGO	PRECIO	INNER	MASTER
STTT1308	\$ 29.00	20	600

## Dimmer atenuador 500 W 36 mm



Color negro

Cuerpo de ABS

Línea 900



CÓDIGO	PRECIO	INNER	MASTER
STDA1310	\$ 132.00	20	600

## Dimmer atenuador 500 W 36 mm



Color gris

Cuerpo de ABS

Línea 900



CÓDIGO	PRECIO	INNER	MASTER
STDA1311	\$ 132.00	20	600

## Toma para teléfono 36 mm



Color gris

Cuerpo de ABS

Línea 900



CÓDIGO	PRECIO	INNER	MASTER
STTT1309	\$ 33.50	20	600

## Contacto para 2 USB 36 mm



Color negro

Cuerpo de ABS

Línea 900



CÓDIGO	PRECIO	INNER	MASTER
STCUSB1814	\$ 168.00	20	600

## Contacto para 2 USB 36 mm



Color gris

Cuerpo de ABS

Línea 900



CÓDIGO	PRECIO	INNER	MASTER
STCUSB1815	\$ 168.00	20	600



LÍNEA 900  
GRIS

Placa con interruptor sencillo 72 mm

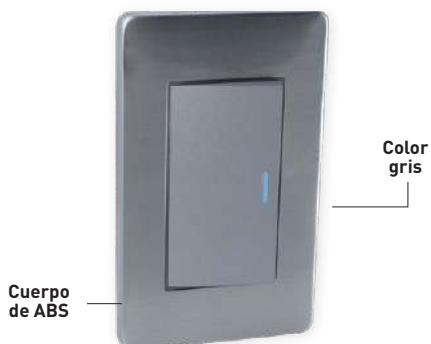

Línea 900



CÓDIGO	PRECIO	INNER	MASTER
STCG001	\$ 60.00	1	15

Placa con 2 interruptores sencillos 36 mm



Placa con interruptor sencillo e interruptor de escalera 36 mm



Línea 900



CÓDIGO	PRECIO	INNER	MASTER
STCG002	\$ 72.00	1	15

Línea 900



CÓDIGO	PRECIO	INNER	MASTER
STCG003	\$ 75.00	1	15

Placa con dos interruptores de escalera 36 mm



Placa con interruptor triple de escalera 72 mm



Línea 900



CÓDIGO	PRECIO	INNER	MASTER
STCG004	\$ 77.00	1	15

Línea 900



CÓDIGO	PRECIO	INNER	MASTER
STCG005	\$ 83.00	1	15

## Placa con contacto doble aterrizado 72 mm

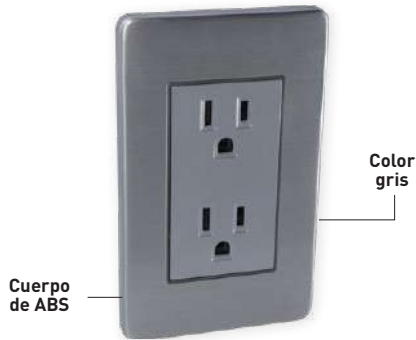

Línea 900

CÓDIGO	PRECIO	INNER	MASTER
STCG006	\$ 70.00	1	15

## Placa con toma para TV 36 mm



Línea 900

CÓDIGO	PRECIO	INNER	MASTER
STCG007	\$ 73.00	1	15

## Placa con toma para teléfono 36 mm

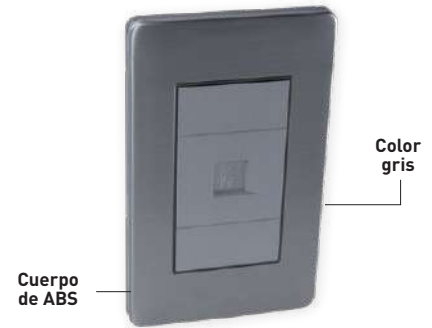

Línea 900

CÓDIGO	PRECIO	INNER	MASTER
STCG008	\$ 72.00	1	15

## Placa con botón para timbre 72 mm



Línea 900

CÓDIGO	PRECIO	INNER	MASTER
STCG009	\$ 62.00	1	15

## Placa con dimmer atenuador rotativo 500 W 36 mm



Línea 900

CÓDIGO	PRECIO	INNER	MASTER
STCG010	\$ 175.00	1	15

## Placa con contacto USB y contacto sencillo aterrizado 36 mm

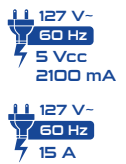

Línea 900

CÓDIGO	PRECIO	INNER	MASTER
STCG011	\$ 220.00	1	15

## Placa con interruptor sencillo y contacto sencillo aterrizado 36 mm



Línea 900

CÓDIGO	PRECIO	INNER	MASTER
STCG012	\$ 75.00	1	15

## Placa con interruptor de escalera y contacto sencillo aterrizado 36 mm



Línea 900

CÓDIGO	PRECIO	INNER	MASTER
STCG014	\$ 76.00	1	15

## Placas ciegas 36 mm



Línea 900

CÓDIGO	PRECIO	INNER	MASTER
STCG015	\$ 55.00	1	15



LÍNEA 900  
NEGRA

Placa con interruptor sencillo 72 mm



Línea 900



CÓDIGO	PRECIO	INNER	MASTER
STCN001	\$ 60.00	1	15

Placa con 2 interruptores sencillos 36 mm



Línea 900



CÓDIGO	PRECIO	INNER	MASTER
STCN002	\$ 72.00	1	15

Placa con interruptor sencillo e interruptor de escalera 36 mm



Línea 900



CÓDIGO	PRECIO	INNER	MASTER
STCN003	\$ 75.00	1	15

Placa con dos interruptores de escalera 36 mm



Línea 900



CÓDIGO	PRECIO	INNER	MASTER
STCN004	\$ 77.00	1	15

Placa con interruptor triple de escalera 72 mm



Línea 900



CÓDIGO	PRECIO	INNER	MASTER
STCN005	\$ 83.00	1	15

## Placa con contacto doble aterrizado 72 mm



Línea 900

CÓDIGO	PRECIO	INNER	MASTER
STCN006	\$ 68.00	1	15

## Placa con toma para TV 36 mm



Línea 900

CÓDIGO	PRECIO	INNER	MASTER
STCN007	\$ 73.00	1	15

## Placa con toma para teléfono 36 mm

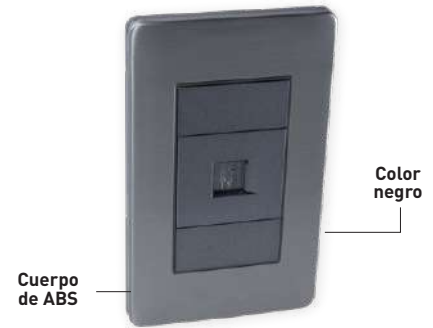

Línea 900

CÓDIGO	PRECIO	INNER	MASTER
STCN008	\$ 72.00	1	15

## Placa con botón para timbre 72 mm



Línea 900

CÓDIGO	PRECIO	INNER	MASTER
STCN009	\$ 62.00	1	15

## Placa con dimmer atenuador rotativo 500 W 36 mm



Línea 900

CÓDIGO	PRECIO	INNER	MASTER
STCN010	\$ 175.00	1	15

## Placa con contacto USB y contacto sencillo aterrizado 36 mm



Línea 900

CÓDIGO	PRECIO	INNER	MASTER
STCN011	\$ 220.00	1	15

## Placa con interruptor sencillo y contacto sencillo aterrizado 36 mm



Línea 900

CÓDIGO	PRECIO	INNER	MASTER
STCN012	\$ 75.00	1	15

## Placa con interruptor de escalera y contacto sencillo aterrizado 36 mm

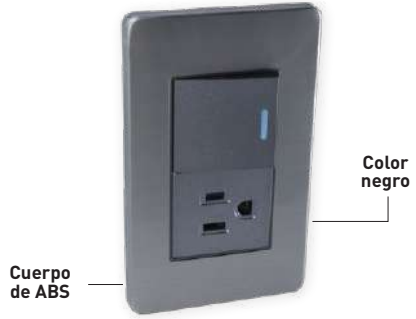

Línea 900

CÓDIGO	PRECIO	INNER	MASTER
STCN014	\$ 76.00	1	15

## Placas ciegas 36 mm



Línea 900

CÓDIGO	PRECIO	INNER	MASTER
STCN015	\$ 55.00	1	15

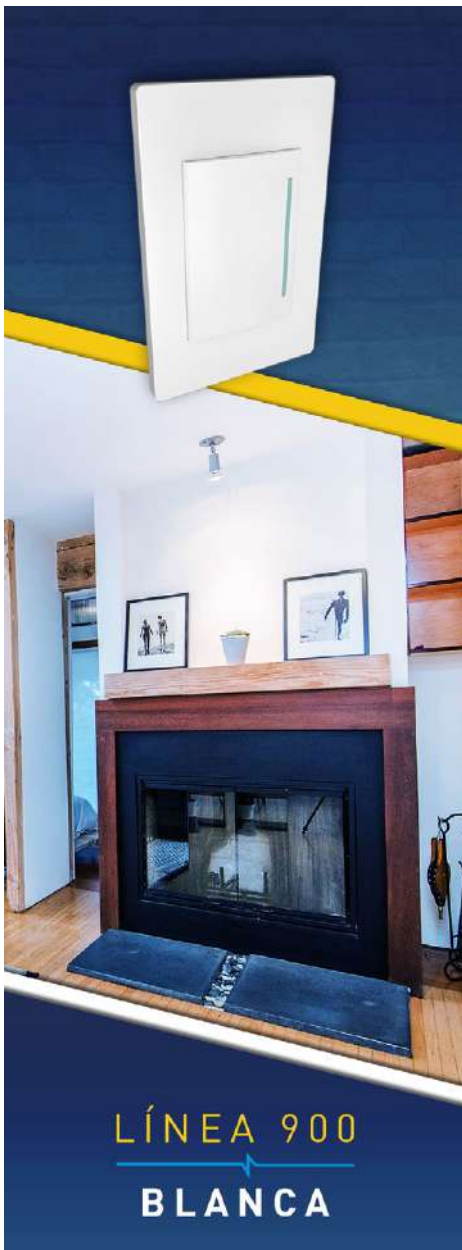

LÍNEA 900  
BLANCA

**Placa con interruptor de escalera 72 mm**

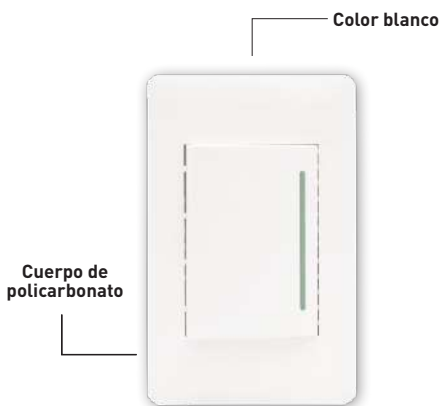

Línea 900		<b>NOM</b>	Bolsa Impresa
CÓDIGO	PRECIO	INNER	MASTER
ST2574	\$ 77.00	12	120

**Placa con interruptor sencillo 72 mm**

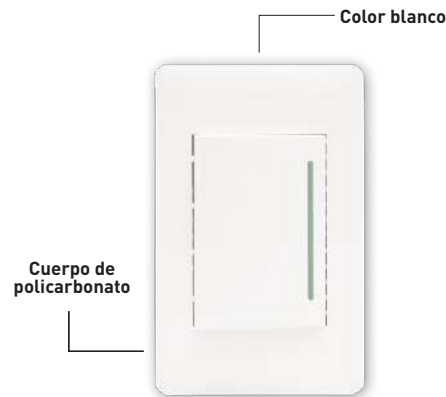

Línea 900		<b>NOM</b>	Bolsa Impresa
CÓDIGO	PRECIO	INNER	MASTER
ST2570	\$ 48.00	12	120

**Placa con 2 interruptores sencillos 36 mm**

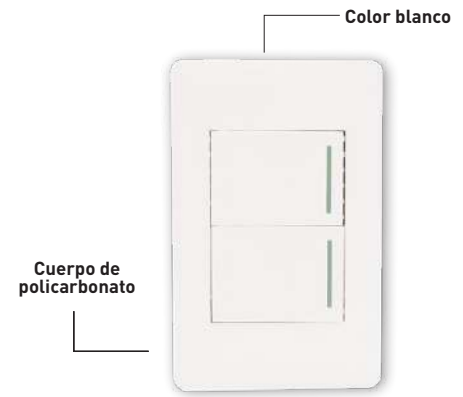

Línea 900		<b>NOM</b>	Bolsa Impresa
CÓDIGO	PRECIO	INNER	MASTER
ST2571	\$ 68.00	12	120

**Placa con interruptor sencillo e interruptor de escalera 36 mm**



Línea 900		<b>NOM</b>	Bolsa Impresa
CÓDIGO	PRECIO	INNER	MASTER
ST2572	\$ 69.00	12	120

**Placa con dos interruptores de escalera 36 mm**



Línea 900		<b>NOM</b>	Bolsa Impresa
CÓDIGO	PRECIO	INNER	MASTER
ST2573	\$ 71.00	12	120

**Placa con interruptor de escalera 72 mm**

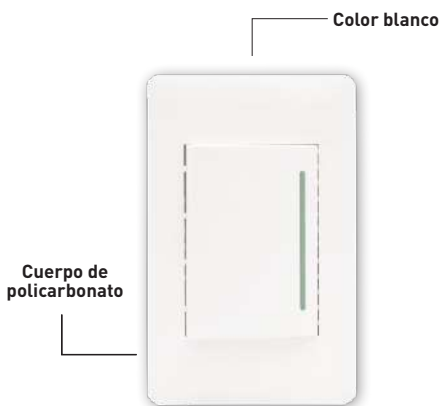

Línea 900		<b>NOM</b>	Bolsa Impresa
CÓDIGO	PRECIO	INNER	MASTER
ST2574	\$ 77.00	12	120

**Placa con contacto doble aterrizado 72 mm**

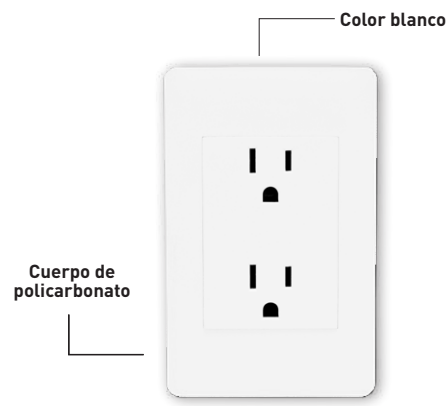

Línea 900		<b>NOM</b>	Bolsa Impresa
CÓDIGO	PRECIO	INNER	MASTER
ST2575	\$ 63.00	12	120

**Placa con botón para timbre 72 mm**



Línea 900		<b>NOM</b>	Bolsa Impresa
CÓDIGO	PRECIO	INNER	MASTER
ST2576	\$ 50.00	12	120

## Placa con dimmer atenuador rotativo 500 W 36 mm



Línea 900 **NOM** Bolsa Impresa

CÓDIGO	PRECIO	INNER	MASTER
ST2577	\$ 144.00	12	120

## Placa con contacto USB y contacto sencillo aterrizado 36 mm

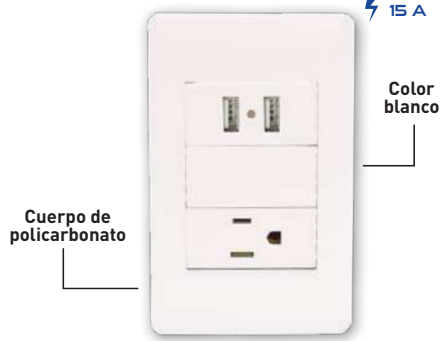

Línea 900 **NOM** Bolsa Impresa

CÓDIGO	PRECIO	INNER	MASTER
ST2578	\$ 223.00	12	120

## Placa con interruptor sencillo y contacto sencillo aterrizado 36 mm



Línea 900 **NOM** Bolsa Impresa

CÓDIGO	PRECIO	INNER	MASTER
ST2579	\$ 65.00	12	120

## Placa con interruptor de escalera y contacto sencillo aterrizado 36 mm



Línea 900 **NOM** Bolsa Impresa

CÓDIGO	PRECIO	INNER	MASTER
ST2580	\$ 67.00	12	120

## Placas ciegas 36 mm



Línea 900 **NOM** Bolsa Impresa

CÓDIGO	PRECIO	INNER	MASTER
ST2581	\$ 40.00	12	120

## Placa con 3 interruptores sencillos 24 mm

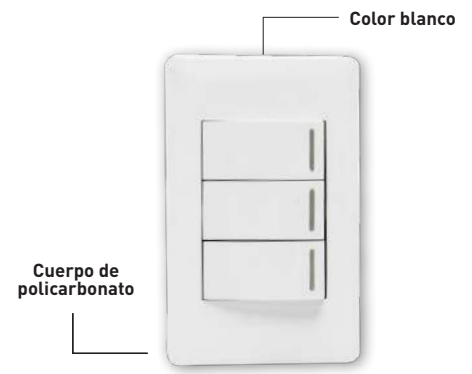

Línea 900 **NOM** Bolsa Impresa

CÓDIGO	PRECIO	INNER	MASTER
ST2582	\$ 85.00	12	120

## Placa con 3 contactos aterrizados 24 mm

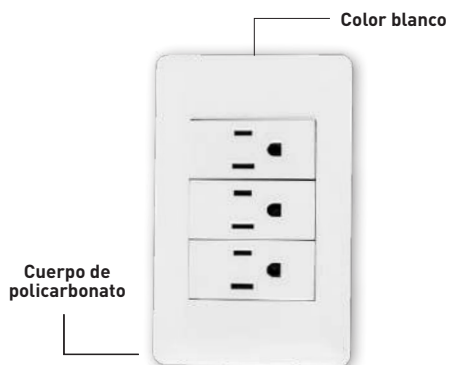

Línea 900 **NOM** Bolsa Impresa

CÓDIGO	PRECIO	INNER	MASTER
ST2583	\$ 85.00	12	120

## Placa con 2 interruptores sencillos y un contacto sencillo aterrizado 24 mm

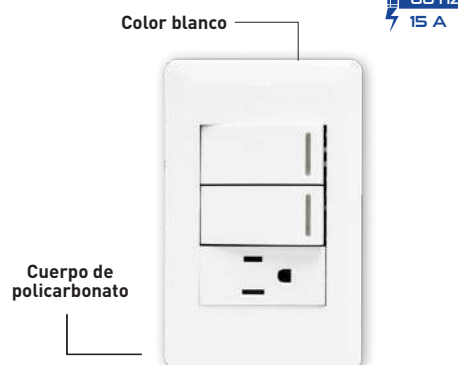

Línea 900 **NOM** Bolsa Impresa

CÓDIGO	PRECIO	INNER	MASTER
ST2584	\$ 85.00	12	120

## Placa con 2 contactos aterrizados y un interruptor sencillo 24 mm

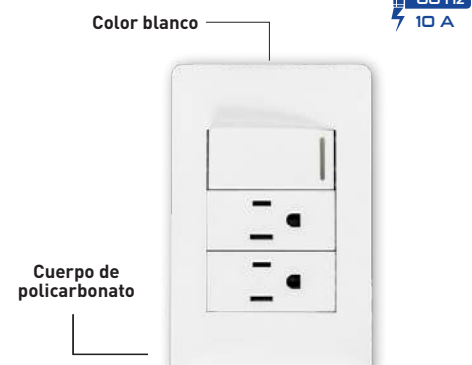

Línea 900 **NOM** Bolsa Impresa

CÓDIGO	PRECIO	INNER	MASTER
ST2585	\$ 85.00	12	120

**Cordón POT blanco**



Tensión máxima 600 V~  
Temperatura de operación 90°  
100 m



CÓDIGO	CALIBRE	INNER
ST2560	Calibre 12	1
ST2561	Calibre 14	1
ST2562	Calibre 16	1
ST2563	Calibre 18	1

**Conductor eléctrico blanco**



Tensión máxima 600 V~  
Temperatura de operación 90°  
100 m



CÓDIGO	CALIBRE	INNER
ST2500	Calibre 8	1
ST2510	Calibre 10	1
ST2520	Calibre 12	1
ST2530	Calibre 14	1

**Conductor eléctrico negro**



Tensión máxima 600 V~  
Temperatura de operación 90°  
100 m



CÓDIGO	CALIBRE	INNER
ST2501	Calibre 8	1
ST2511	Calibre 10	1
ST2521	Calibre 12	1
ST2531	Calibre 14	1

**Conductor eléctrico verde**



Tensión máxima 600 V~  
Temperatura de operación 90°  
100 m



CÓDIGO	CALIBRE	INNER
ST2503	Calibre 8	1
ST2513	Calibre 10	1
ST2523	Calibre 12	1
ST2533	Calibre 14	1

**Conductor eléctrico rojo**



Tensión máxima 600 V~  
Temperatura de operación 90°  
100 m



CÓDIGO	CALIBRE	INNER
ST2502	Calibre 8	1
ST2512	Calibre 10	1
ST2522	Calibre 12	1
ST2532	Calibre 14	1

**Cable THW blanco**

Tensión máxima 600 V~  
Temperatura de operación 90°  
Puresa del cobre 99.99%



**Cable THW negro**

Tensión máxima 600 V~  
Temperatura de operación 90°  
Puresa del cobre 99.99%



**Cable THW rojo**

Tensión máxima 600 V~  
Temperatura de operación 90°  
Puresa del cobre 99.99%



CÓDIGO	CALIBRE	DESCRIPCIÓN	INNER
STCEBC8	Calibre 8	100 m	1
STCEBC10	Calibre 10	100 m	1
STCEBC12	Calibre 12	100 m	1
STCEBC14	Calibre 14	100 m	1
STCEBC12500	Calibre 12	500 m	1

CÓDIGO	CALIBRE	DESCRIPCIÓN	INNER
STCENC8	Calibre 8	100 m	1
STCENC10	Calibre 10	100 m	1
STCENC12	Calibre 12	100 m	1
STCENC14	Calibre 14	100 m	1
STCENC12500	Calibre 12	500 m	1

CÓDIGO	CALIBRE	DESCRIPCIÓN	INNER
STCERC8	Calibre 8	100 m	1
STCERC10	Calibre 10	100 m	1
STCERC12	Calibre 12	100 m	1
STCERC14	Calibre 14	100 m	1
STCERC12500	Calibre 12	500 m	1

**Cable THW verde**

100 m  
Tensión máxima 600 V~  
Temperatura de operación 90°  
Puresa del cobre 99.99%



**Alambre doble TWD gris**

100 m  
Tensión máxima 300 V~  
Temperatura de operación 60°  
Puresa del cobre 99.99%



**Cordón POT blanco**

100 m  
Tensión máxima 300 V~  
Temperatura de operación 60°  
Puresa del cobre 99.99%



CÓDIGO	CALIBRE	INNER
STCEVC8	Calibre 8	1
STCEVC10	Calibre 10	1
STCEVC12	Calibre 12	1
STCEVC14	Calibre 14	1

CÓDIGO	CALIBRE	INNER
STAG2C12	Calibre 12	1
STAG2C14	Calibre 14	1

CÓDIGO	CALIBRE	INNER
STCPBC12	Calibre 12	1
STCPBC14	Calibre 14	1
STCPBC16	Calibre 16	1



## Guía para electricista profesional

Guía de acero al alto carbono

Cuerpo resistente al impacto



CÓDIGO	DESC.	PRECIO	INNER	MASTER
TPFT50	15 m	\$ 260.00	1	12
TPFT100	30 m	\$ 350.00	1	10

## Abrazadera omega

Para conduit eléctrico  
Tubería de cobre y CPVC

Banda de acero al carbón

Acabado galvanizado



CÓDIGO	DESC.	PRECIO	INNER	MASTER
A012	1/2" (12.7 mm)	\$ 2.00	100	1000
A034	3/4" (19 mm)	\$ 2.20	100	1000
A01	1" (25.4 mm)	\$ 3.00	50	500
A0114	1 1/4" (31.7 mm)	\$ 4.50	50	500
A0112	1 1/2" (38.1 mm)	\$ 5.00	50	500
A0134	1 3/4" (44.4 mm)	\$ 5.20	50	500
A02	2" (50.8 mm)	\$ 6.20	25	500

## Abrazadera uña

Para conduit eléctrico  
Tubería de cobre y CPVC

Banda de acero al carbón

Acabado galvanizado



CÓDIGO	DESC.	PRECIO	INNER	MASTER
AU12	1/2" (12.7 mm)	\$ 2.00	100	1000
AU34	3/4" (19 mm)	\$ 2.20	100	1000
AU1	1" (25.4 mm)	\$ 3.00	50	500
AU114	1 1/4" (31.7 mm)	\$ 4.50	50	500
AU112	1 1/2" (38.1 mm)	\$ 5.00	50	500
AU2	2" (50.8 mm)	\$ 6.20	50	500

## Cinchos de plástico bolsa c/ 100 piezas

Útiles para:  
Mecánica  
Uso eléctrico  
Jardín  
Herramientas

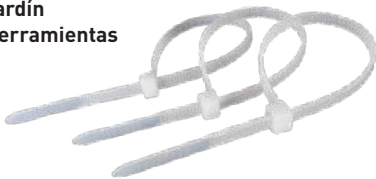

CÓDIGO	DESC.	PRECIO	INN.	MAS.
TPCABT25100	4" 2.5 x 100 mm	\$ 13.00	1	500
TPCABT36150	6" 3.6 x 150 mm	\$ 29.00	1	300
TPCABT48200	8" 4.8 x 200 mm	\$ 58.00	1	200
TPCABT48300	12" 4.8 x 300 mm	\$ 85.00	1	100
TPCABT48350	14" 4.8 x 350 mm	\$ 105.00	1	100

## Grapa para cable Redonda

Redonda  
Paquete con 20 piezas

Cuerpo de polietileno



CÓDIGO	DESC.	PRECIO	INN.	MAS.
TPGC316	5 mm	\$ 5.00	1	1,000
TPGC317	6 mm	\$ 6.00	1	500
TPGC318	8 mm	\$ 6.50	1	500
TPGC319	10 mm	\$ 9.00	1	500
TPGC320	12 mm	\$ 11.00	1	500
TPGC321	16 mm	\$ 16.00	1	250

## Grapa para cable Plana

Plana  
Paquete con 20 piezas

Cuerpo de polietileno



CÓDIGO	DESC.	PRECIO	INN.	MAS.
TPGC322	4 x 5 mm	\$ 5.50	1	500
TPGC323	5 x 8 mm	\$ 6.50	1	500
TPGC324	5 x 10 mm	\$ 7.50	1	500

## Capuchón para cable eléctrico

Cuerpo de polipropileno

Inserto metálico



TPC1069

TPC1070



Paquete con 10 piezas

CÓDIGO	DESC.	PRECIO	INNER	MASTER
TPC1069	10-12	\$ 10.50	20	200
TPC1070	12-14	\$ 13.00	20	200

## Cinta aislante

Adhesivo acrílico

Flexible para cubrir superficies irregulares

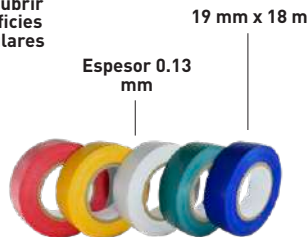

Espesor 0.13 mm

19 mm x 18 m



CÓDIGO	DESC.	PRECIO	INNER	MASTER
CE18MR	Roja	\$ 15.00	10	250
CE18MV	Verde	\$ 15.00	10	250
CE18MA	Amarilla	\$ 15.00	10	250
CE18MB	Blanca	\$ 15.00	10	250
CE18MAZ	Azul	\$ 15.00	10	250

## Cinta aislante negra

Adhesivo acrílico

Flexible para cubrir superficies irregulares



Espesor 0.13 mm



CÓDIGO	DESC.	PRECIO	INNER	MASTER
CE10M	19 mm x 10 m	\$ 8.00	10	250
CE18M	19 mm x 18 m	\$ 14.00	10	250

### Linterna recargable 29 LEDS

15 Horas de luz continua



Incluye correa 90 cm ajustable



#### ESPECIFICACIONES TÉCNICAS

Potencia	19 Leds 0.7 W 10 Leds 0.4 W
Luz alta:	19 LEDS
Luz baja:	7 LEDS
Luz lateral:	10 LEDS
Batería recargable	2 x 4 Vcc / 800 mA

CÓDIGO	PRECIO	INNER	MASTER
TPLR479	\$ 220.00	1	16

### Linterna recargable 1 LED de alto alcance

8 Horas de luz continua



Clavija retráctil

Equivalente a la luz de 12 leds (regulares)

Luz led de 2 tiempos



#### ESPECIFICACIONES TÉCNICAS

Flujo luminoso	80 Lúmenes
Batería recargable	4 Vcc / 1000 mA

CÓDIGO	PRECIO	INNER	MASTER
TPLR480	\$ 123.00	12	48

### Linterna recargable para auto

Cuerpo de aluminio



8 horas de luz continua

Led de mayor alcance

Mango antideslizante

Incluye brújula



#### ESPECIFICACIONES TÉCNICAS

Potencia	1 W
Flujo luminoso	80 Lúmenes

CÓDIGO	PRECIO	INNER	MASTER
TPLRA481	\$ 270.00	10	20

### Linterna cabeza 12 LEDS

8 Horas de luz continua



Recargable

Clavija retráctil

Cabeza giratoria

Banda elástica ajustable

Manos libres

Indicador de carga



#### ESPECIFICACIONES TÉCNICAS

Luz alta:	12 LEDS
Luz baja:	6 LEDS
Inclinación	120°

CÓDIGO	PRECIO	INNER	MASTER
TPLC558	\$ 115.00	12	48

### Linterna recargable halógeno 10 W y 9 LEDS

Producto sujeto a disponibilidad



Base ajustable para colgar soporte

Incluye cargadores 127 V~ y 12 V~

Cuerpo de ABS

Incluye correa 79 cm ajustable



#### ESPECIFICACIONES TÉCNICAS

Mango ajustable	180°
Batería recargable	9 Vcc/300 mA

CÓDIGO	PRECIO	INNER	MASTER
TPLR331	\$ 500.00	1	12

### Linterna recargable 9 LEDS

Cuerpo ABS

15 Horas de luz continua

Clavija retráctil

Indicador de carga



#### ESPECIFICACIONES TÉCNICAS

Luz alta:	9 LEDS
Luz baja:	5 LEDS
Batería recargable	4 Vcc / 800 mA

CÓDIGO	PRECIO	INNER	MASTER
TPLR344	\$ 90.00	6	36

### Linterna recargable 11 LEDS

Cuerpo ABS

15 Horas de luz continua

Clavija retráctil

Indicador de carga



#### ESPECIFICACIONES TÉCNICAS

Batería recargable	4 Vcc/1000 mA
--------------------	---------------

CÓDIGO	PRECIO	INNER	MASTER
TPLR345	\$ 136.00	6	36

### Linterna recargable 3 LEDS

Cuerpo ABS

15 Horas de luz continua

Clavija retráctil

Indicador de carga



#### ESPECIFICACIONES TÉCNICAS

Batería recargable	4 Vcc/600 mA
--------------------	--------------

CÓDIGO	PRECIO	INNER	MASTER
TPFLR3	\$ 60.00	12	48

### Linterna recargable 4 LEDS

Cuerpo ABS

15 Horas de luz continua

Clavija retráctil

Indicador de carga



#### ESPECIFICACIONES TÉCNICAS

Batería recargable	4 Vcc/600 mA
--------------------	--------------

CÓDIGO	PRECIO	INNER	MASTER
TPFLR4	\$ 72.00	12	48

El aspecto, empaque, inner o master de los productos puede variar sin previo aviso debido a la innovación continua de nuestras marcas.

# ANTENAS

STROM®

## Antena conejo salida coaxial

MOQ 20,000

Rango de frecuencia: 45 - 860

MHz

4 Secciones de barra

790 mm largo por barra

800 mm largo del cable



## Antena conejo con base salida coaxial

MOQ 20,000

Rango de frecuencia: 45 - 860 MHz

4 Secciones de barra

500 mm largo por barra

800 mm largo del cable



CÓDIGO	PRECIO	INNER	MASTER
TPAC330	\$ 26.00	36	288

CÓDIGO	PRECIO	INNER	MASTER
TPAC329	\$ 32.00	1	100

# STROM® LINTERNAS



# STROM® línea LED



ANTENAS

El aspecto, empaque, inner o master de los productos puede variar sin previo aviso debido a la innovación continua de nuestras marcas.

# EXHIBIDORES

MERCHANDISING  
Y MATERIAL POP





3 TAMAÑOS DISPONIBLES



AHORRAN ESPACIO



15 RANURAS



ECONÓMICOS

## EXHIBIDORES MODULARES

Una **NUEVA OPCIÓN** para exhibir nuestras marcas en espacios limitados

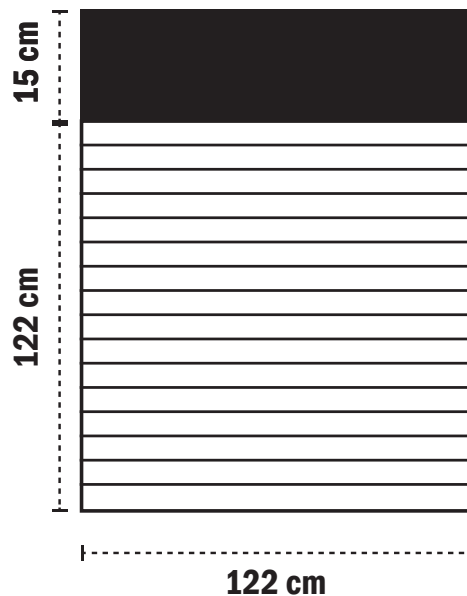
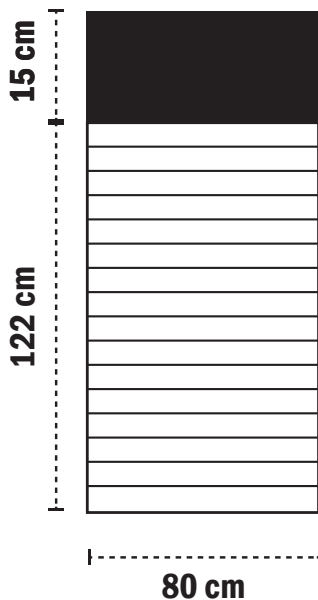
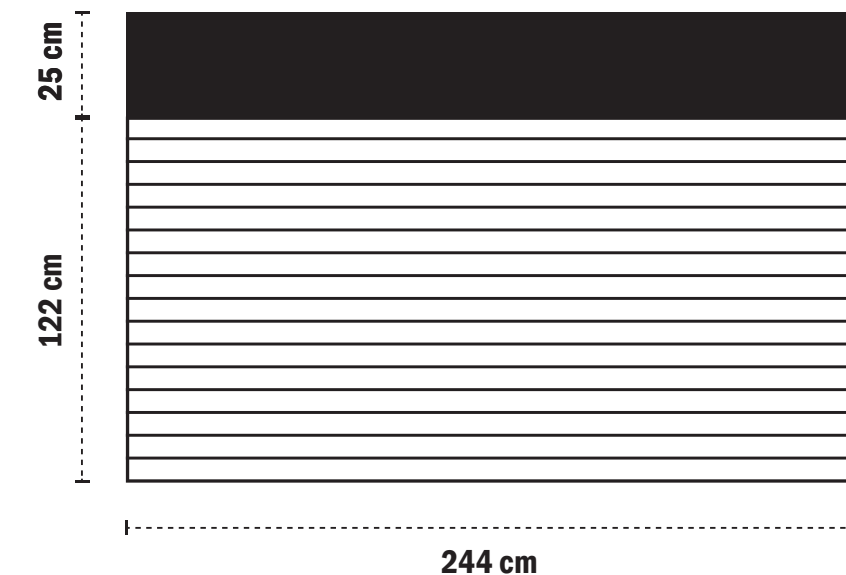

CENEFA INCLUIDA



MODULARES

\*Consulte precios y disponibilidad con su asesor de ventas

## Panel ranurado chico

CÓDIGO PANRAN14

Cenefa incluida

No incluye producto ni monturas

SHUTZ se maneja en fondo negro

80 cm

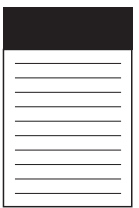

122 cm



## Cenefa chica

80 x 15 cm

CÓDIGO ANPR1982



CÓDIGO TPPR1983



CÓDIGO BKPR1984



CÓDIGO SHPR1986



CÓDIGO MYPR1987



CÓDIGO STPR1985



EXHIBIDORES MODULARES

El aspecto de los productos puede variar sin previo aviso debido a la innovación continua de nuestras marcas

# EXHIBIDORES MODULARES

\*Consulte precios y disponibilidad con su asesor de ventas

## Panel ranurado mediano

CÓDIGO PANRAN12

Cenefa incluida

No incluye producto ni monturas

SHUTZ se maneja en fondo negro

122 cm

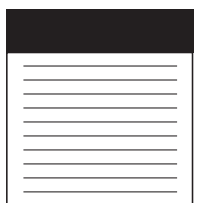

122 cm



## Cenefa mediana

122 x 15 cm

CÓDIGO ANPR1977

CÓDIGO TPR1978

CÓDIGO SHPR1980



CÓDIGO MYPR1981

CÓDIGO STPR1979



El aspecto de los productos puede variar sin previo aviso debido a la innovación continua de nuestras marcas

EXHIBIDORES MODULARES

\*Consulte precios y disponibilidad con su asesor de ventas

## Panel ranurado grande

CÓDIGO PANRAN

Cenefa incluida

No incluye producto ni monturas

244 cm

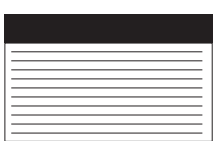

122 cm

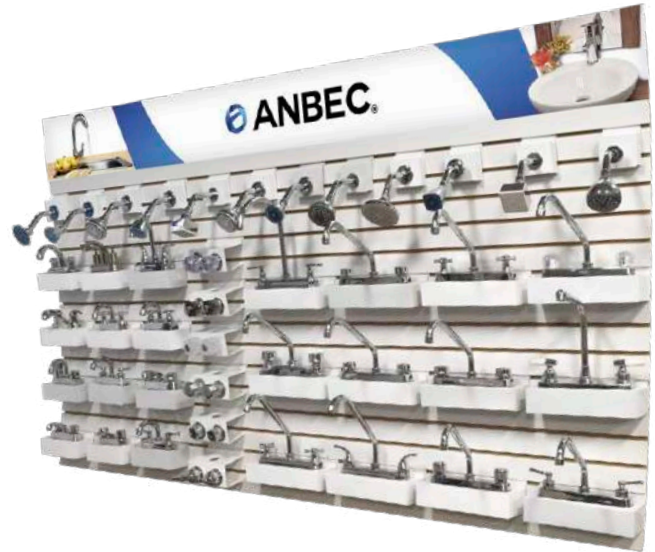

## Cenefa grande

244 x 25 cm

CÓDIGO ANPR1974



CÓDIGO TPR1975



CÓDIGO ABPR1976



El aspecto de los productos puede variar sin previo aviso debido a la innovación continua de nuestras marcas





## Exhibidor modular de pared con base

100 x 200 x 50 cm

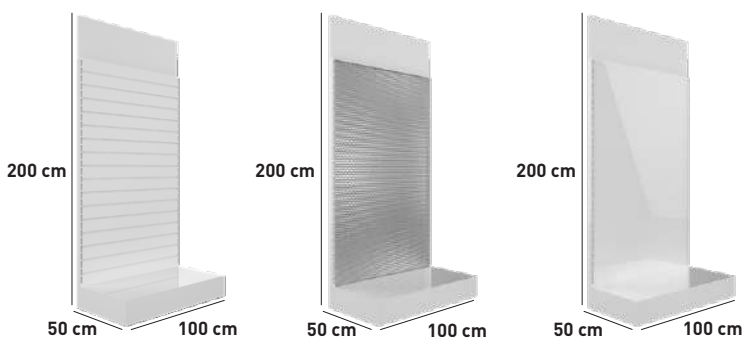

CÓDIGO EMOD1973

CÓDIGO EMOD1974

CÓDIGO EMOD1975

EXHIBIDOR MODULAR  
**GRATIS**

En la compra de  
\$ 35,000.00 o más

## Exhibidor modular de pared con base SHUTZ

100 x 200 x 50 cm

CÓDIGO EMOD1975-S

Dinámico  
Panel de melamina  
Incluye cenefa  
Para todos los  
productos SHUTZ  
No incluye producto



Cajonera de 6 cajones se puede  
comprar por separado (opcional).  
EMOD2000 - \$ 7,000.00

EXHIBIDOR MODULAR  
**GRATIS**

En la compra de  
\$ 80,000.00 o más

## Exhibidor modular de pared sencillo

100 x 175 x 5.08 cm

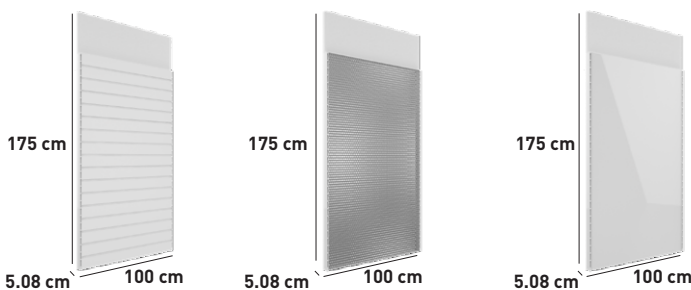

CÓDIGO EMOD1976

CÓDIGO EMOD1977

CÓDIGO EMOD1978

EXHIBIDOR MODULAR  
**GRATIS**

En la compra de  
\$ 32,000.00 o más

## Exhibidor modular de pared sencillo SHUTZ

100 x 175 x 5.08 cm

CÓDIGO EMOD1978-S

Dinámico  
Panel de melamina  
Incluye cenefa  
Para todos los  
productos SHUTZ  
No incluye producto



EXHIBIDOR MODULAR  
**GRATIS**

En la compra de  
\$ 42,000.00 o más

## Exhibidor modular isla

100 x 160 x 100

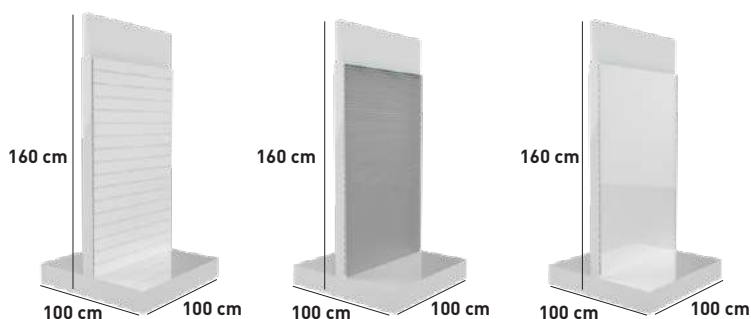

CÓDIGO EMOD1979

CÓDIGO EMOD1980

CÓDIGO EMOD1981

EXHIBIDOR MODULAR  
**GRATIS**

En la compra de  
\$ 75,000.00 o más

El aspecto de los productos puede variar sin previo aviso debido a la innovación continua de nuestras marcas

## Modulos para tarjas

2 tamaños distintos, 2 posiciones diferentes

### Exhibición dinámica

\*No incluye tarjas



**CÓDIGO** EMOD1985  
**PRECIO** \$ 3,500.00

63 x 100 cm



Posición horizontal y vertical

**CÓDIGO** EMOD1986  
**PRECIO** \$ 6,350.00

63 x 200 cm



## Modulo para ovalines

65 x 37.5 x 37.5 cm

\*No incluye ovalín

**CÓDIGO** EMOD1988  
**PRECIO** \$ 520.00



## Cenefa

3 Diferentes tamaños

	MEDIDA 30 cm x 1 m	MEDIDA 30 cm x 2 m	MEDIDA 30 cm x 3 m
MARCA	CÓDIGO	CÓDIGO	CÓDIGO
ANBEC COCINA	ANCC1	ANCC2	ANCC3



	MEDIDA 30 cm x 1 m	MEDIDA 30 cm x 2 m	MEDIDA 30 cm x 3 m
MARCA	CÓDIGO	CÓDIGO	CÓDIGO
STROM	STCF1	STCF2	STCF3



	MEDIDA 30 cm x 1 m	MEDIDA 30 cm x 2 m
MARCA	CÓDIGO	CÓDIGO
BITKA	BKCF1	BKCF2



ANBEC BAÑO	ANCB1	ANCB2	ANCB3
------------	-------	-------	-------



SHUTZ	SHCF1	SHCF2	SHCF3
-------	-------	-------	-------



MYPAT	MYCF1	N/A
-------	-------	-----



TRUEPOWER	TPCF1	TPCF2	TPCF3
-----------	-------	-------	-------



MASTERPROOF	MPCF1	MPCF2	MPCF3
-------------	-------	-------	-------



## Barra de sujeción

1 m x 2"

**CÓDIGO** BSJ1982  
**PRECIO** \$ 200.00



## Sujeta martillos y hachas

No incluye martillos

**CÓDIGO** MM1983  
**PRECIO** \$ 135.00

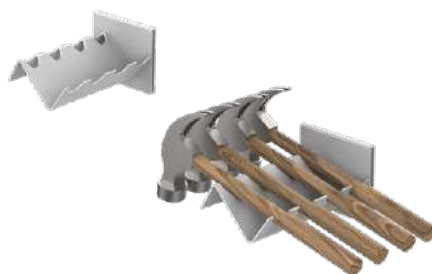

## Repisa

100 x 45 cm

**CÓDIGO** REP1984  
**PRECIO** \$ 400.00

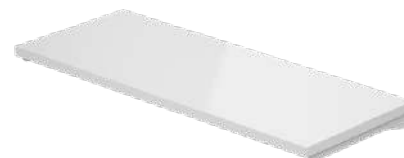

El aspecto de los productos puede variar sin previo aviso debido a la innovación continua de nuestras marcas

# EXHIBIDORES

## Exhibidor mezcladoras lavabo y fregadero

95 x 65 cm



**CÓDIGO** EM15  
**PRECIO** \$ 5,000.00

**Incluye:**

- 1 MEZB1090
- 1 MEZB1080
- 1 MEZL4084
- 1 MEZL110PP
- 1 MEZF8080
- 1 MEZF8070
- 1 MEZF8011
- 1 MEZF8012

## Exhibidor mixto

180 x 72 x 57 cm



**CÓDIGO** EMN01

**Modelos a escoger:**

- 4 Mezcladoras de fregadero
- 4 Mezcladoras de lavabo
- 5 Regaderas
- 4 Llaves de jardín
- 2 Contracanasas
- 1 Trampa fregadero o lavabo
- 1 Desagüe doble
- 2 Juegos llave para regadera
- 4 Alimentadores

**ESTRUCTURA GRATIS** En la compra de \$ 20,000.00 o más

## Exhibidor mixto

72 x 59 x 65 cm



**CÓDIGO** EMN02

Puede incluir modelos de la familia **ANBEC** y **BitKQ**.

**Modelos a escoger:**

- 2 Mezcladoras de fregadero
- 4 Mezcladoras de lavabo
- 4 Regaderas
- 2 Juegos de llaves de empotrar

**ESTRUCTURA GRATIS** En la compra de \$ 8,000.00 o más

## Exhibidor 6 tarjetas chico

212 x 70 x 86 cm



**CÓDIGO** ET04

**Puede incluir:**

- |       |        |           |
|-------|--------|-----------|
| T1010 | T1095  | T2075     |
| T1020 | T1697  | T2080     |
| T1030 | T1698  | T2090     |
| T1040 | T19196 | T4540     |
| T1050 | T2000  | TIN15156  |
| T1055 | T2005  | TIN25226  |
| T1060 | T2010  | TIN33226M |
| T1062 | T2015  | TIN33226M |
| T1070 | T2020  | TIN33196B |
| T1075 | T2025  | TIN33196M |
| T1080 | T2045  | TIN33227  |
| T1085 | T2055  | TIN33228  |
| T1090 | T2065  |           |

**ESTRUCTURA GRATIS** En la compra de \$ 15,000.00 o más

## Exhibidor escalonado

214 x 117 x 62 cm



**CÓDIGO** EEA904

**Modelos a escoger:**

- 1 Juego de accesorios para baño
- 5 Juegos de maneral
- 3 Mezcladoras fregadero
- 4 Mezcladoras lavabo
- 5 Regaderas
- 1 Tarja

**ESTRUCTURA GRATIS** En la compra de 5 PIEZAS de cada modelo a escoger

## Exhibidor mixto blanco

209 x 188 x 79 cm



**CÓDIGO** EMB14

**Modelos a escoger:**

- 10 Regaderas
- 2 Juegos de accesorios para baño
- 6 Mezcladoras fregadero
- 1 Juego de llave para empotrar
- 1 Portavasos
- 2 Tarjas
- 8 Mezcladoras lavabo
- 8 Juegos de maneral
- 1 Barra de apoyo
- 5 Ganchos
- 1 Portarrollo

**ESTRUCTURA GRATIS** En la compra de 8 PIEZAS de cada modelo a escoger

## Exhibidor ovalines

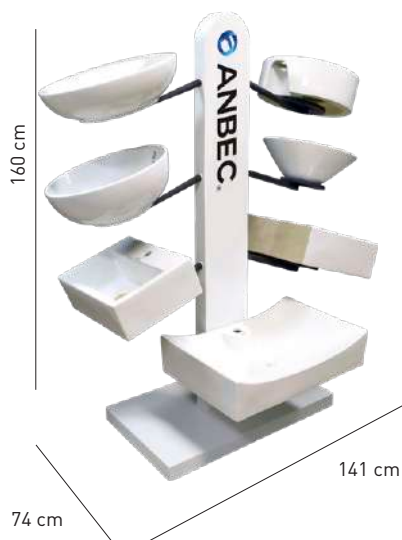

**CÓDIGO** EXHOV  
**PRECIO** \$ 12,500.00

**Incluye ovalines:**

- VERNAZZA (ABOV1819)
- GLORENA (ABOV1824)
- MANTOVA (ABOV1821)
- ATRANI (ABOV1823)
- BIELLA (ABOV1825)
- DOZZA (ABOV1826)
- MISURINA (ABOV1822)

## Exhibidor mezcladoras de 6 lados

200 x 62 x 60 cm



**CÓDIGO** EM11

**Incluye:**

- 16 Mezcladoras fregadero
- 16 Mezcladoras lavabo
- 16 Tipo bar

La mercancía a exhibir es a gusto de cada cliente

**ESTRUCTURA GRATIS** En la compra de \$ 70,000.00 o más

## Exhibidor accesorios para baño

235 x 75 x 10 cm



**CÓDIGO** EAB09

**Incluye:**

- 10 modelos de accesorios para baño
- La mercancía a exhibir es a gusto de cada cliente

SE ENTREGA EN 2 MÓDULOS DE: 1.15 M

**ESTRUCTURA GRATIS** En la compra de \$ 40,000.00 o más

## Exhibidor abanico

174 x 92 cm



**CÓDIGO** EA1053

**Incluye:**

- 10 Mezcladoras fregadero
- 10 Mezcladoras lavabo
- 8 Regaderas
- 8 Juegos de maneral

**ESTRUCTURA GRATIS** En la compra de 5 piezas de cada modelo a escoger

## Montura para mezcladora fregadero metálica

**CÓDIGO** MM016  
**PRECIO** \$ 90.00

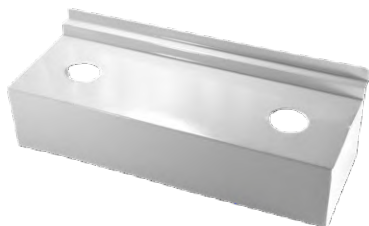

## Montura para mezcladora lavabo metálica

**CÓDIGO** MM017  
**PRECIO** \$ 90.00

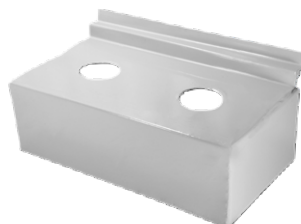

## Montura para regadera metálica

**CÓDIGO** MM018  
**PRECIO** \$ 55.00



Todas las monturas incluyen etiquetas personalizadas. Favor de consultar a su agente para más detalles.

# EXHIBIDORES

## Exhibidor valvulería para agua

50 x 70 cm

EXHIBIDOR  
NUEVO

Incluye producto

CÓDIGO EXAN101  
PRECIO \$ 4,100.00



## Exhibidor conexiones para agua

30 x 40 cm

EXHIBIDOR  
NUEVO

Incluye producto

CÓDIGO EXAN102  
PRECIO \$ 1,750.00



## Exhibidor valvulería para gas

40 x 60 cm

EXHIBIDOR  
NUEVO

Incluye producto

CÓDIGO EXAN103  
PRECIO \$ 2,060.00



## Exhibidor PP-R chico

40 x 30 cm

EXHIBIDOR  
NUEVO

Incluye producto

CÓDIGO EXAN104  
PRECIO \$ 590.00



## Exhibidor CPVC chico

40 x 30 cm

EXHIBIDOR  
NUEVO

Incluye producto

CÓDIGO EXAN105  
PRECIO \$ 535.00



## Exhibidor línea de cartuchos

40 x 60 cm

Incluye producto

CÓDIGO EXH-VAST  
PRECIO \$ 2,000.00



## Exhibidor PP-R

40 x 60 cm

Incluye:

Toda la sección PP-R

CÓDIGO EPPR1054  
PRECIO \$ 2,190.00



## Exhibidor CPVC

40 x 60 cm

Incluye:

Toda la sección CPVC en 1/2" y tubo de 1/2", 3/4" y 1"

CÓDIGO ECPVC  
PRECIO \$ 1,509.00

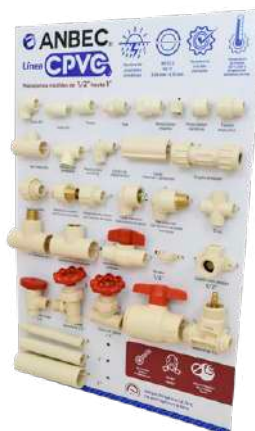

## Exhibidor línea de impermeabilizantes

40 x 60 cm

CÓDIGO MPPR1974  
PRECIO \$ 350.00



## Exhibidor de tornillos

40 x 60 cm

EXHIBIDOR  
NUEVO



CÓDIGO EXSH100

PRECIO \$ 550.00

## Exhibidor de armellas y aldabas

50 x 40 cm

EXHIBIDOR  
NUEVO



CÓDIGO EXSH101

PRECIO \$ 800.00

## Exhibidor de bisagras

60 x 50 cm

EXHIBIDOR  
NUEVO



CÓDIGO EXSH102

PRECIO \$ 950.00

## Exhibidor de bisagras

30 x 50 cm

EXHIBIDOR  
NUEVO



CÓDIGO EXSH103

PRECIO \$ 880.00

## Exhibidor de candados

40 x 60 cm

EXHIBIDOR  
NUEVO



CÓDIGO EXSH104

PRECIO \$ 2,900.00

## Exhibidor de cerraduras

40 x 60 cm

EXHIBIDOR  
NUEVO



CÓDIGO EXSH106

PRECIO \$ 3,200.00

## Exhibidor de rieles

40 x 60 cm

EXHIBIDOR  
NUEVO



CÓDIGO EXSH105

PRECIO \$ 770.00

El aspecto de los productos puede variar sin previo aviso debido a la innovación continua de nuestras marcas

# EXHIBIDORES

## Exhibidor de chapas

200 x 60 x 60 cm



**CÓDIGO** EM11-S

### Modelos a escoger:

- 8 Cerraduras principales
- 8 Cerrojos
- 8 Cerraduras combo
- 8 Cerraduras con llave
- 8 Cerraduras sin llave
- 3 Cerraduras esfera con llave
- 3 Cerraduras esferas sin llave
- 3 Pasadores para puerta

**ESTRUCTURA GRATIS** En la compra de \$ 70,000.00 o más

### Restricciones:

- Solo modelos SHUTZ
- 5 piezas de cada código

## Exhibidor shutz

100 x 200 cm



**CÓDIGO** EISH1991

Incluye cenefa  
Panel de melamina  
No incluye producto  
Para todos los  
productos SHUTZ

**EXHIBIDOR MODULAR GRATIS**

En la compra de \$ 75,000.00 o más

## Exhibidor shutz

25 x 45 x 25 cm



**CÓDIGO** EMSH1992

**PRECIO** \$ 2,000.00

**Dinámico**  
Panel de melamina  
Incluye 3 cerraduras  
a elección del cliente

El aspecto de los productos puede variar sin previo aviso debido a la innovación continua de nuestras marcas

## Exhibidor herramienta para pintar

60 x 122 cm

EXHIBIDOR  
NUEVO

CÓDIGO EPTP006  
PRECIO \$ 1,400.00



## Exhibidor herramienta construcción

100 x 122 cm

EXHIBIDOR  
NUEVO

CÓDIGO EATP002  
PRECIO \$ 3,700.00



## Exhibidor herramienta carpintería

122 x 122 cm

EXHIBIDOR  
NUEVO

CÓDIGO ECTP004  
PRECIO \$ 7,100.00



## Exhibidor brocas para concreto SDS PRO

65 x 35 cm

EXHIBIDOR  
NUEVO

CÓDIGO EBTPP010  
PRECIO \$ 1,750.00



## Exhibidor brocas para concreto SDS

65 x 35 cm

EXHIBIDOR  
NUEVO

CÓDIGO EBTP011  
PRECIO \$ 1,400.00



## Exhibidor brocas para concreto

35 x 25 cm

EXHIBIDOR  
NUEVO

CÓDIGO EBCTP012  
PRECIO \$ 500.00



## Exhibidor brocas para metal alta velocidad

35 x 25 cm

EXHIBIDOR  
NUEVO

CÓDIGO EBMT013  
PRECIO \$ 700.00



## Exhibidor brocas brocas manita

25 x 45 cm

EXHIBIDOR  
NUEVO

CÓDIGO EBMT014  
PRECIO \$ 2,600.00

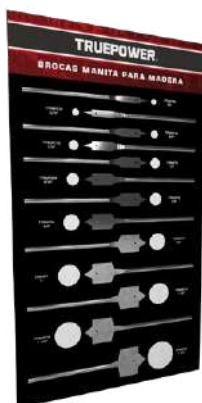

## Exhibidor de bandolas

40 x 60 cm

EXHIBIDOR  
NUEVO

CÓDIGO EBTP001  
PRECIO \$ 1,600.00



El aspecto de los productos puede variar sin previo aviso debido a la innovación continua de nuestras marcas



# EXHIBIDORES

## Exhibidor herramienta mecánica

122 x 122 cm

EXHIBIDOR  
NUEVO



CÓDIGO **EMTP005**  
PRECIO **\$ 6,400.00**

## Exhibidor soldadoras

97 x 165 x 60 cm

EXHIBIDOR  
NUEVO



CÓDIGO **ESTP008**  
PRECIO **\$ 41,300.00**



Incluye  
rodajas que  
facilitan su  
movilidad

## Exhibidor ménsulas

100 x 120 cm

EXHIBIDOR  
NUEVO



CÓDIGO **EMTP007**  
PRECIO **\$ 2,400.00**

## Exhibidor 6 escaleras

117 x 91 x 66 cm

No incluye escaleras



CÓDIGO **EE1003**  
PRECIO **\$ 4,600.00**

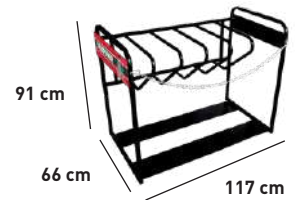

Incluye cenefas laterales



## Exhibidor 4 escaleras

78 x 91 x 66 cm

No incluye escaleras



CÓDIGO **EE1002**  
PRECIO **\$ 3,300.00**



Incluye cenefas laterales



## Exhibidor 3 escaleras

59 x 91 x 66 cm

No incluye escaleras



CÓDIGO **EE1001**  
PRECIO **\$ 3,050.00**



Incluye cenefas laterales



## Exhibidor brochas

120 x 85 x 36 cm

**CÓDIGO** EBT02  
**PRECIO** \$ 6,500.00



Incluye:

- |           |           |
|-----------|-----------|
| 12 TPB12  | 4 TPEM240 |
| 12 TPB1   | 4 TPEM3   |
| 12 TPB112 | 6 TPM9E   |
| 12 TPB2   | 6 TPM9P   |
| 12 TPB212 | 5 TPF38   |
| 12 TPB3   | 5 TPF34   |
| 12 TPB4   | 5 TPF1    |
| 12 TPB5   | 5 TPF114  |
| 12 TPB6   | 15 TPCHP  |
| 8 TPB120  |           |

## Exhibidor señaletica

214 x 77 cm

**CÓDIGO** ES014  
**PRECIO** \$ 9,000.00



Incluye:

- |          |          |
|----------|----------|
| 3 TPS190 | 3 TPS204 |
| 3 TPS191 | 3 TPS205 |
| 3 TPS192 | 3 TPS206 |
| 3 TPS193 | 3 TPS207 |
| 3 TPS194 | 3 TPS208 |
| 3 TPS195 | 3 TPS209 |
| 3 TPS196 | 3 TPS210 |
| 3 TPS197 | 3 TPS211 |
| 3 TPS198 | 3 TPS212 |
| 3 TPS199 | 3 TPS212 |
| 3 TPS200 | 3 TPS212 |
| 3 TPS201 | 3 TPS279 |
| 3 TPS202 | 3 TPS280 |
| 3 TPS203 |          |

## Exhibidor aerosoles 120 botes

178 x 66 x 16 cm

**CÓDIGO** EA120B  
**PRECIO** \$ 8,250.00



Incluye:

- 84 Colores básicos
- 15 Fluorescentes
- 9 Alta temperatura
- 12 Metálicos

## Exhibidor aerosoles 30 botes

68 x 38 x 24 cm

**CÓDIGO** EA30B  
**PRECIO** \$ 3,100.00



Incluye:

- 15 Colores básicos
- 6 Fluorescentes
- 3 Alta temperatura
- 6 Metálicos

## Exhibidor cadena pulida

145 x 70 x 30 cm

**CÓDIGO** ECP1052  
**PRECIO** \$ 13,300.00



Incluye:

- 1 TPCP961
- 1 TPCP962
- 1 TPCP963
- 1 TPCP964
- 1 TPCP965
- 1 TPCP966

## Exhibidor de herramientas

150 x 136 x 45 cm

**CÓDIGO** EH1047  
**PRECIO** \$ 19,750.00



Incluye:

- |           |            |
|-----------|------------|
| 4 TPTM434 | 1 TPM291   |
| 4 TPZM433 | 4 TPMH436  |
| 4 TPM979  | 1 TPTP787  |
| 4 TPMM441 | 1 TPTH387  |
| 4 TPMM442 | 1 TPH392   |
| 2 TPAM657 | 1 TPH393   |
| 2 TPAM658 | 1 TPH394   |
| 4 TPM435  | 2 TPZ386   |
| 2 TPM284  | 3 TPM283   |
| 2 TPM285  | 4 TPH112FV |
| 2 TPM286  | 4 TPH400   |
| 2 TPM287  | 2 TPH437   |
| 2 TPM288  | 2 TPH438   |
| 1 TPM289  | 2 TPH439   |
| 1 TPM290  |            |

## Exhibidor de herramientas

200 x 60 x 60 cm

**CÓDIGO** EM11-T



**ESTRUCTURA GRATIS** En la compra de \$ 70,000.00 o más

## Exhibidor carretilla

62 x 56 x 36 cm

**CÓDIGO** EC1050  
**PRECIO** \$ 1,900.00

**CÓDIGO** EC1049  
**PRECIO** \$ 1,900.00



# EXHIBIDORES

## Exhibidor de lijas chico

70 x 30 x 25 cm

**CÓDIGO** EL1358CH  
**PRECIO** \$ 3,100.00



**Incluye:**  
9 paquetes de lijas a gusto del cliente

## Exhibidor de lijas grande

158 x 40 x 33 cm

**CÓDIGO** EL1358G  
**PRECIO** \$ 6,000.00



**Incluye:**  
19 paquetes de lijas a gusto del cliente

## Exhibidor de palas

214 x 74 x 74 cm

**CÓDIGO** EP1048  
**PRECIO** \$ 6,900.00



**Incluye:**  
2 TP105  
1 TP103  
1 TP107  
2 TP106  
3 TP102  
6 TP101  
2 TP104  
3 TPMP786

## Exhibidor conexiones

40 x 60 cm

**CÓDIGO** ECST003  
**PRECIO** \$ 950.00

EXHIBIDOR NUEVO



## Exhibidor probador de focos

12.8 x 17.4 cm cm

**CÓDIGO** EST001  
**PRECIO** \$ 200.00

EXHIBIDOR NUEVO



## Exhibidor eléctrico

20.35 x 40.66 cm

**CÓDIGO** ECES01  
**PRECIO** \$ 200.00

EXHIBIDOR NUEVO



## Exhibidor abrazaderas

40 x 20 cm

**CÓDIGO** EAST009  
**PRECIO** \$ 550.00

EXHIBIDOR NUEVO



## Exhibidor línea 300

40 x 60 cm



CÓDIGO EL300

PRECIO \$ 1,450.00

### Incluye:

**1**  
 Interruptor sencillo (ASA803)  
 Contacto polarizado (TPA806)  
 Contacto aterrizado (TAA804)  
 Placa triple (PTA813)

**2**  
 Contacto polarizado (TPA806)  
 Contacto aterrizado (TAA804)  
 Placa doble (PDA812)

**3**  
 Interruptor escalera (AEA807)  
 Placa sencilla (PSA811)

**4**  
 Interruptor sencillo (ASA803)  
 Interruptor escalera (AEA807)  
 Contacto aterrizado (TAA804)  
 Placa triple (PTA813)

**5**  
 Toma para televisión (TTA809)  
 Placa sencilla (PSA811)

**6**  
 Toma para teléfono (TTA810)  
 Placa sencilla (PSA811)

**7**  
 Contacto aterrizado (TAA804)  
 Placa sencilla (PSA811)

**8**  
 Interruptor timbre (BTA805)  
 Placa sencilla (PSA811)

**9**  
 Contacto doble aterrizado (TDA808)  
 Placa abierta (PAA814)

## Exhibidor línea 600

40 x 60 cm



CÓDIGO EL600

PRECIO \$ 1,450.00

### Incluye:

**1**  
 Interruptor sencillo (ASA821)  
 Placa sencilla (PSA818)

**2**  
 Interruptor doble (ADA820)  
 Placa sencilla (PSA818)

**3**  
 Interruptor triple (ATA819)  
 Placa sencilla (PSA818)

**4**  
 Contacto doble aterrizado (TDA822)  
 Placa sencilla (PSA818)

**5**  
 Toma para televisión (TTA815)  
 Placa sencilla (PSA818)

**6**  
 Toma para teléfono (TTA816)  
 Placa sencilla (PSA818)

**7**  
 Placa ciega (PCA817)

**8**  
 Interruptor sencillo (ASA821)  
 Placa sencilla (PSA818)

**9**  
 Placa ciega (PCA817)

El aspecto de los productos puede variar sin previo aviso debido a la innovación continua de nuestras marcas

# EXHIBIDORES

## Exhibidor línea 900 básico

40 x 60 cm



CÓDIGO	EL900
CÓDIGO	EL9002
PRECIO	\$ 1,800.00

### Incluye:

- |   |   |   |
|---|---|---|
| <p><b>1</b></p> <ul style="list-style-type: none"> <li>• Interruptor sencillo 72 mm<br/>Negro (STAS1302)<br/>Gris (STAS1303)</li> <li>• Placa abierta (STPA1301)</li> </ul>   | <p><b>2</b></p> <ul style="list-style-type: none"> <li>• 2 Interruptores sencillos 36 mm<br/>Negro (STAS1295)<br/>Gris (STAS1296)</li> <li>• Placa abierta (STPA1301)</li> </ul>  | <p><b>3</b></p> <ul style="list-style-type: none"> <li>• Interruptor triple 72 mm<br/>Negro (STAT1306)<br/>Gris (STAT1307)</li> <li>• Placa abierta (STPA1301)</li> </ul> |
| <p><b>4</b></p> <ul style="list-style-type: none"> <li>• Interruptor sencillo 36 mm<br/>Negro (STAS1295)<br/>Gris (STAS1296)</li> <li>• Contacto sencillo 36 mm<br/>Negro (STTS1297)<br/>Gris (STTS1298)</li> <li>• Placa abierta (STPA1301)</li> </ul> | <p><b>5</b></p> <ul style="list-style-type: none"> <li>• Contacto doble aterrizado 72 mm<br/>Negro (STTD1299)<br/>Gris (STTD1300)</li> <li>• Placa abierta (STPA1301)</li> </ul>  | <p><b>6</b></p> <ul style="list-style-type: none"> <li>• Interruptor timbre 72 mm<br/>Negro (STBT1304)<br/>Gris (STBT1305)</li> <li>• Placa abierta (STPA1301)</li> </ul> |
| <p><b>7</b></p> <ul style="list-style-type: none"> <li>• Toma para televisión<br/>Negro (STTT1312)<br/>Gris (STTT1313)</li> <li>• Contacto sencillo 36 mm<br/>Negro (STTS1297)<br/>Gris (STTS1298)</li> <li>• Placa abierta (STPA1301)</li> </ul>       | <p><b>8</b></p> <ul style="list-style-type: none"> <li>• Toma para teléfono 36 mm<br/>Negro (STTT1308)<br/>Gris (STTT1309)</li> <li>• Contacto sencillo 36 mm<br/>Negro (STTS1297)<br/>Gris (STTS1298)</li> <li>• Placa abierta (STPA1301)</li> </ul> | <p><b>9</b></p> <ul style="list-style-type: none"> <li>• 2 Placas ciegas 18 mm<br/>Negro (STPC1314)<br/>Gris (STPC1315)</li> <li>• Placa abierta (STPA1301)</li> </ul>    |

## Exhibidor línea 900 premium

40 x 60 cm



CÓDIGO	EL9001
CÓDIGO	EL9003
PRECIO	\$ 2,300.00

### Incluye:

- |  |   |  |
|--|---|--|
| <p><b>1</b></p> <ul style="list-style-type: none"> <li>• Interruptor sencillo 72 mm<br/>Negro (STAS1302)<br/>Gris (STAS1303)</li> <li>• Placa abierta (STPA1301)</li> </ul>  | <p><b>2</b></p> <ul style="list-style-type: none"> <li>• 2 Interruptores sencillos 36 mm<br/>Negro (STAS1295)<br/>Gris (STAS1296)</li> <li>• Placa abierta (STPA1301)</li> </ul>  | <p><b>3</b></p> <ul style="list-style-type: none"> <li>• Interruptor triple 72 mm<br/>Negro (STAT1306)<br/>Gris (STAT1307)</li> <li>• Placa abierta (STPA1301)</li> </ul>  |
| <p><b>4</b></p> <ul style="list-style-type: none"> <li>• Interruptor timbre 72 mm<br/>Negro (STBT1304)<br/>Gris (STBT1305)</li> <li>• Placa abierta (STPA1301)</li> </ul>  | <p><b>5</b></p> <ul style="list-style-type: none"> <li>• Interruptor sencillo 36 mm<br/>Negro (STAS1295)<br/>Gris (STAS1296)</li> <li>• Contacto sencillo 36 mm<br/>Negro (STTS1297)<br/>Gris (STTS1298)</li> <li>• Placa abierta (STPA1301)</li> </ul>   | <p><b>6</b></p> <ul style="list-style-type: none"> <li>• Contacto doble aterrizado 72 mm<br/>Negro (STTD1299)<br/>Gris (STTD1300)</li> <li>• Placa abierta (STPA1301)</li> </ul>   |
| <p><b>7</b></p> <ul style="list-style-type: none"> <li>• Dimmer atenuador<br/>Negro (STDA1310)<br/>Gris (STDA1311)</li> <li>• Contacto sencillo 36 mm<br/>Negro (STTS1297)<br/>Gris (STTS1298)</li> <li>• Placa abierta (STPA1301)</li> </ul>          | <p><b>8</b></p> <ul style="list-style-type: none"> <li>• Toma para televisión 36 mm<br/>Negro (STTT1312)<br/>Gris (STTT1313)</li> <li>• Contacto sencillo 36 mm<br/>Negro (STTS1297)<br/>Gris (STTS1298)</li> <li>• Placa abierta (STPA1301)</li> </ul>   | <p><b>9</b></p> <ul style="list-style-type: none"> <li>• Contacto doble para USB 36 mm<br/>Negro (STCUSB1814)<br/>Gris (STCUSB1815)</li> <li>• Contacto sencillo 36 mm<br/>Negro (STTS1297)<br/>Gris (STTS1298)</li> <li>• Placa abierta (STPA1301)</li> </ul> |
| <p><b>10</b></p> <ul style="list-style-type: none"> <li>• Toma para teléfono 36 mm<br/>Negro (STTT1308)<br/>Gris (STTT1309)</li> <li>• Contacto sencillo 36 mm<br/>Negro (STTS1297)<br/>Gris (STTS1298)</li> <li>• Placa abierta (STPA1301)</li> </ul> | <p><b>11</b></p> <ul style="list-style-type: none"> <li>• Toma para televisión 36 mm<br/>Negro (STTT1312)<br/>Gris (STTT1313)</li> <li>• Toma para teléfono 36 mm<br/>Negro (STTT1308)<br/>Gris (STTT1309)</li> <li>• Placa abierta (STPA1301)</li> </ul> | <p><b>12</b></p> <ul style="list-style-type: none"> <li>• 2 Placas ciegas 18 mm<br/>Negro (STPC1314)<br/>Gris (STPC1315)</li> <li>• Placa abierta (STPA1301)</li> </ul>  |

\*Consulte precios y disponibilidad con su asesor de ventas

### Gorra bordada

Bordado con el nombre de tu ferretería

Lavable

Ligera

Producto **NUEVO**

Nombre de tu ferretería

10 cm



ANBEC  
www.anbec.com

9 cm

### Playera polo bordada

Bordado con el nombre de tu ferretería

3 cm  
Nombre de tu ferretería  
9 cm



### Camiseta estampada

Estampado con el nombre de tu ferretería

ANBEC  
www.anbec.com



Producto **NUEVO**

#### Gorra anbec

CÓDIGO	DESCRIPCIÓN	PRECIO
ANPR1991	CHICA	\$ 225.00

#### Playera Polo

CÓDIGO	DESCRIPCIÓN	PRECIO
ANPR1992	CHICA	\$ 425.00
ANPR1993	MEDIANA	\$ 425.00
ANPR1994	GRANDE	\$ 425.00
ANPR1995	EXT. GRANDE	\$ 435.00
ANPR1996	EXT. EXT. GRANDE	\$ 435.00

#### Camiseta cuello redondo

CÓDIGO	DESCRIPCIÓN	PRECIO
ANPR1997	CHICA	\$ 165.00
ANPR1998	MEDIANA	\$ 165.00
ANPR1999	GRANDE	\$ 165.00
ANPR2000	EXT. GRANDE	\$ 168.00
ANPR2001	EXT. EXT. GRANDE	\$ 168.00

### Camisa manga larga para mujer bordada

Bordado con el nombre de tu ferretería

3 cm  
Nombre de tu ferretería  
9 cm

ANBEC  
www.anbec.com

Producto **NUEVO**



### Camisa manga larga para hombre bordada

Bordado con el nombre de tu ferretería

3 cm  
Nombre de tu ferretería  
9 cm

ANBEC  
www.anbec.com

Producto **NUEVO**



CÓDIGO	DESCRIPCIÓN	PRECIO
ANPR2002	CHICA	\$ 950.00
ANPR2003	MEDIANA	\$ 950.00
ANPR2004	GRANDE	\$ 950.00
ANPR2005	EXT. GRANDE	\$ 960.00
ANPR2006	EXT. EXT. GRANDE	\$ 960.00

CÓDIGO	DESCRIPCIÓN	PRECIO
ANPR2007	CHICA	\$ 950.00
ANPR2008	MEDIANA	\$ 950.00
ANPR2009	GRANDE	\$ 950.00
ANPR2010	EXT. GRANDE	\$ 960.00
ANPR2011	EXT. EXT. GRANDE	\$ 960.00

El aspecto de los productos puede variar sin previo aviso debido a la innovación continua de nuestras marcas

# PROMOCIONALES

## Carpa plegable

2.90 x 2.90 x 3.30 m

Producto  
**NUEVO**



Estuche  
158 x 24 x 22 mm  
24 kg



CÓDIGO ANCARPA PRECIO \$ 4,300.00

\*Consulte precios y disponibilidad con su asesor de ventas

## Bolsa plástica

30 x 60 cm

Paquete de 100 piezas

Producto  
**NUEVO**



CÓDIGO ANPR1990 PRECIO \$ 700.00

## Cilindro para agua

580 ml



CÓDIGO ANPR1937 PRECIO \$ 100.00

## Taza cafetera



Ceramica

CÓDIGO ANPR1942 PRECIO \$ 70.00

## Termo para café

500 ml



CÓDIGO AMPR1938 PRECIO \$ 220.00

## Balón de futbol soccer



CÓDIGO ANPR1941 PRECIO \$ 250.00

## Maleta deportiva

Altura: 26 cm  
Base: 55 cm  
Fondo: 19 cm



100 % Poliéster

CÓDIGO ANPR1940 PRECIO \$ 700.00

## Mochila ejecutiva

Altura: 48 cm  
Base: 33.5 cm  
Fondo: 24 cm

Compartimientos  
interiores



Soportes  
acojinados

100 % Poliéster

CÓDIGO ANPR1939 PRECIO \$ 870.00

\*Consulte precios y disponibilidad con su asesor de ventas

## Maleta deportiva

Altura: 26 cm  
Base: 55 cm  
Fondo: 19 cm



100 % Poliéster

CÓDIGO MCD01 PRECIO \$ 650.00

## Mochila ejecutiva

Altura: 48 cm  
Base: 33.5 cm  
Fondo: 24 cm

Compartimientos interiores



Soportes acojinados

100 % Poliéster

CÓDIGO MES02 PRECIO \$ 850.00

## Balón de basketball



CÓDIGO TPR1001 PRECIO \$ 240.00

## Termo para agua



CÓDIGO MPPR1936 PRECIO \$ 70.00

## Ventilador de mano



CÓDIGO MYPR1001 PRECIO \$ 200.00

## Pelota anti-estrés



CÓDIGO SHPR1001 PRECIO \$ 30.00

## Linterna de dinamo



CÓDIGO STPR1001 PRECIO \$ 50.00

## Bolígrafos



MARCA	CÓDIGO
Anbec	1929D1-LB
Bitka	1929D1-O
Masterproof	1929D1-B
Mypat	1929D1-G
Shutz	1929D1-Y
Truepower	1929D1-R
Strom	1929D1-DB

PRECIO \$ 10.00



MARCA	CÓDIGO
Grupo Anbec	1929D1-GA

PRECIO \$ 30.00

## Catálogo Grupo Anbec 2019



CÓDIGO CAT2019V PRECIO \$ 150.00

El aspecto de los productos puede variar sin previo aviso debido a la innovación continua de nuestras marcas





CÓDIGO	PÁG	CÓDIGO	PÁG	CÓDIGO	PÁG	CÓDIGO	PÁG	CÓDIGO	PÁG	CÓDIGO	PÁG	CÓDIGO	PÁG		
MEZF1643	23	CUBFC	34	JM510BN	42	R826	49	MEZL8030BN	57	ABOV1821	68	ESPM050	80		
MEZF8041BN	23	T5001	35	JM6027	42	R475	49	MEZL1760	57	ABOV1825	68	ESPM030	80		
MEZF8044	23	T5005	35	JM016CD	42	R8447C	49	MEZL4036	57	ABOV1822	68	ESPM046	80		
MEZF1642	23	CEDCAC	35	JM016BC	42	RCBP	49	MEZL8032	57	ABM01895	69	ESPM043	80		
AE2001	14	MEZF8090	23	CEDCO	35	JM6059C	42	R1018	49	MEZTY848CK	57	ABM01896	69	ESPM045	80
AE1002	15	MEZF1758	23	CEDUC	35	JM6059BN	42	R1015	50	MEZL8027	57	ABM01897	69	ESPM004	80
AE1004	15	ABMF1927	23	CONCPVC	35	JM019C	42	RMCH	50	MEZL8028C	57	ABM01834	69	JM1006	81
AE1005	15	MEZF790C	23	CONCPVCT	35	JM019	42	R2020	50	MEZL8024	57	ABM01835	69	CV1005	81
AE1006	15	MEZF790BN	23	CONMTB	35	JM019S	42	RM5002	50	MEZL8045	58	ABM01836	69	PS1004	81
AE1001	15	MEZF1641	24	CONCM	35	JM0842	42	REGAML	50	MEZL8042	58	ABM01898	70	PMC789	81
AE1003	15	MEZF8088	24	CONCMT	35	JM0848	43	R320	50	MEZL8041	58	ABM01899	70	PRE300	81
ABOV1830	17	MEZF1764C	24	CONCM1998	35	JM0872	43	R218	50	MEZL8041BN	58	ABM01900	70	PB1001	81
ABOV1831	17	ABMF1926	24	MM1720	36	JM0846	43	R326	50	MEZ0403CBH8	58	ABM01837	70	PC1316	81
ABOV1832	17	MEZF8046C	24	JMM1455	36	JMA824C	43	R0093C	50	MEZL4033C	58	ABM01838	70	BT1003	81
ABOV1828	17	MEZF8046BN	24	MANST	36	JMA824	43	R005CP	51	MEZL4033BN	58	ABM01839	70	ABDP1914	82
ABOV1827	17	MEZF8287C	24	M901	36	JMA824BN	43	R1016	51	ABML1924	58	ABM01901	71	ABDP1912	82
ABOV1829	17	MEZF8287BN	24	JSM200	36	JMA821	43	R005WK	51	MEZL0404CBH6	59	ABM01902	71	ABDP1913	82
ABOV1833	17	MEZF8286C	24	JSM201	36	JM6012C	43	R005K	51	MEZL8040	59	ABM01903	71	DPB400	82
ANTS1912	18	MEZF8286BN	25	CLA4	36	JMR847	43	R5019S	51	MEZL4060C	59	ABM01840	71	DPB401	82
ANTS1913	18	ABLL1932	25	CFA8	36	JM6012S	43	R5019BN	51	MEZL4059BN	59	ABM01841	71	DPWCN	82
ANTS1914	18	ANMF1792	25	GM901N	36	JM6018G	43	RC4	51	ABML1925	59	ABM01842	71	DPWCJ	82
ANTS1915	18	MEZF773C	25	GM901B	36	JMH804	43	RC6	51	MEZTY846	59	ABM01904	72	DPW788A	82
ANJH1911	18	MEZF7795C	25	GM901C	36	JE004	44	RC8	51	MEZL120	60	ABM01905	72	DPRMJ	82
ABMM1882	18	MEZF9220	25	AREMRE	37	JE002	44	R4NP	51	MEZL697	60	ABM01906	72	SMBAA	82
ABMM1883	18	MEZF8082C	25	AREMRI	37	JESM	44	R6NP	51	MEZL119	60	ABM01843	72	SP1018	83
ABMM1884	18	MEZF8082BN	25	TMG12	37	JERM	44	R8NP	51	MEZL119BN	60	ABM01844	72	SP1028	83
ABMM1885	18	MEZF8084C	25	TMGCG	37	JE001	44	RC59S	51	MEZL112	60	ABM01845	72	SAPC	83
ABMM1886	18	MEZF8084BN	26	R0C2P	37	JE003	44	R443C	52	MEZL1473	60	ABM01907	73	SAPC705	83
ABMM1887	18	MEZF8083C	26	GAR12	37	JESA	44	R444C	52	ABLP1910	60	ABM01908	73	SAPC763	83
TPVC1001	19	MEZF8083BN	26	GARTB	37	JERA	44	R443BN	52	MEZL51045	60	ABM01909	73	SAPA1731	83
TPVC1002	19	MEZF9212	26	GARTBBN	37	JE1649	44	R444BN	52	MEZB1080	61	ABM01892	73	VS1012	83
TPVC1003	19	MEZF9020	26	GARGC	37	JE1648	44	RC592	52	MEZB1090	61	ABM01893	73	VS617	83
CPVC1004	19	MEZF9020BN	26	GARCA	37	JE1647	44	R592NP	52	MEZB470	61	ABM01894	73	JH1011	83
CPVC1005	19	MEZF15001LC	26	G2008C	37	MEZR8236C	45	R769C	52	MEZB107A	61	ABAC1405	74	JH1012	83
CPVC1006	19	MEZF15001LBN	26	G2008N	37	MEZR8236BN	45	R770BN	52	MEZB4003	61	JAB017PVC	74	VE620	84
CPVC1007	19	MEZF1411CB	27	TUBC10P	38	MEZR8237C	45	R1784C	52	MEZB469	61	JAB017S	74	VWCP799	84
CPVC1008	19	MEZF14901C	27	TUBC15M	38	MEZR8237BN	45	R1776C	52	MEZB4096	61	JAB1132C	74	VES1203	84
CPVC1009	19	MEZF14901BN	27	EXTFPVC	38	MEZR2001	45	R1777C	52	MEZB107	61	JAB1133CD	74	VE987	84
COPVC1010	19	MEZF14901W	27	EXTFM	38	MEZR1801	45	R1778C	52	MEZB4065C	61	JAB3100C	74	VSS1204	84
COPVC1011	19	MEZF458C	27	TRA452	38	MEZR1802	45	R1779C	52	MEZB4065BN	62	JAB3100CD	74	EMPE	85
COPVC1012	19	MEZF458BN	27	TRA465	38	MEZRT1812	45	R1785C	52	ABML1923	62	JAB7600C	74	EE1025	85
TAPVC1013	19	MEZF459C	27	TRAFM	38	MEZRT1811	45	R1780C	52	MEZB8029	62	JAB1500C	75	FP1015	85
TAPVC1014	19	MEZF459BN	27	DD1040	38	MEZRT2008	46	R1781C	52	MEZB8025BN	62	JAB7206C	75	ABCU1851	85
TAPVC1015	19	MEZF474	28	DD1050	38	MEZRT2008BN	46	R1782C	52	MEZL1806	62	JAB6100CD	75	FP1773	85
TEPVC1016	19	MEZF457C	28	DD1030	38	MEZR2005	46	R1783C	52	MEZB107KCP2	62	JAB5020C	75	VF1014	85
TEPVC1017	19	MEZF457BN	28	DESDFM	38	MEZR2005BN	46	R1288C	52	MEZB2993	62	JAB5020BN	75	MANSM	85
TEPVC1018	19	MEZF1761C	28	ABTF1846	38	MEZR1238C	46	R994C	52	MEZB1759	62	JAB1300C	75	MAN5670	85
RBPVC1019	19	MEZF1761BN	28	ABTD1847	38	MEZR1238BN	46	R1289BN	52	MEZB4136	63	JAB8906C	75	MP1016	85
RBPVC1020	19	TIN15156	29	CFIE	39	MEZR131C	46	R995BN	52	MEZB4140	63	JAB8906BN	75	BDFS1808	85
RBPVC1021	19	T1062	29	CF05	39	MEZR132BN	46	RE5500	53	MEZB1644	63	JAB2806C	76	BDFS1809	85
AREPVC1022	19	T1060	29	LGA1062	39	DESTPVC	46	RE1719	53	MEZB1645	63	JAB2806BN	76	D1030R	85
AREPVC1023	19	T19196	29	ADAF	39	DESTL	46	RE1720	53	MEZB1646	63	JAB3900CS	76	D1318R	85
AREPVC1024	19	TIN25226	29	AF03	39	MEZRT182	47	ANRE1941	53	MEZL791C	63	JAB6106C	76	DTA1721	85
ARIPVC1025	19	T1010	29	AF04	39	MEZRT50246C	47	ANRE1943	53	JAB6106CD	63	ASISCS70	86	ELF1022	92
ARIPVC1026	19	T1020	29	GARF	39	MEZRT5023C	47	ANRE1942	53	MEZL206BN	63	JAB6106BN	76	ASISMB	86
ARIPVC1027	19	T1090	29	GF02	39	MEZRT5023BN	47	BRE218	53	MEZL791BN	63	JAB6800BC	76	ASISMH	86
TUPVC1028	19	T1095	29	RFA10	39	NAR79040	47	BRE1718	53	MEZL207C	64	JAB6800BD	76	ASISMBE	86
TUPVC1029	19	T1030	30	RFA25	39	NAR79050	47	REE	53	MEZL4207BN	64	JAB6800CD	77	ASISL569	86
TUPVC1030	19	T1040	30	RFA50	39	PUST	47	ANRE1944	53	MEZL139C	64	JAB2170C	77	ASISL569H	86
ANCK1822	19	TIN33196M	30	FAA10	39	PUSTPVC	47	ANRE1945	53	MEZL140C	64	JAB2170BN	77	ASISMLB	86
ANCK1823	19	TIN33196B	30	FAA25	39	BC1005CP	48	DESTRTA	53	ANMM1789	64	JAB1520C	77	ASISMLH	86
KITPPR1909	19	TIN33226M	30	FAA50	39	BC1005CM	48	R5001	54	ANMM1788	64	JAB1520BN	77	ASISLAL	86
ANCH1978	19	TIN33226B	30	CHARLC	40	BC1005S	48	R306L	54	ANMM1787	64	JAB54005S	77	ASISLA647	86
MEZF8015	20	TIN33227	30	CHARO17C	40	BC1005DM	48	R511C	54	ANMM1786	64	ORB1694	77	ASISLA647	86
MEZF8050	20	TIN33228	30	CHARO17BN	40	BC1005BN	48	R511NP	54	ANMM1791	64	ORB1695	77	ASIN1856	86
MEZF8012	20	T2055	30	CHARO17G	40	BC30CM	48	RT2558C	54	MEZL136BN	65	ORB1696	77	ASIN1855	86
MEZF8010	20	T2045	31	JMANIB	40	BC37CM	48	RT247BC	54	MEZL135C	65	REB45	78	ASISAB	86
MEZF8033	20	T2075	31	JMANIC	40	BC39CM	48	RT136BC	54	ANMM1790	65	TC1102C	78	ASISAN	86
MEZF8204	20	T2065	31	JMANIM	40	BC30A	48	RT445C	54	MEZL137C	65	R3306	78	ASISAVJ	86
MEZF8011	20	T4540	31	JMANICR	40	BC37A	48	RT1763	54	MEZL138BN	65	RC502	78	ASISAAC	86
MEZF8044	20	T2015	31	JM0606	40	BC39A	48	MEZL4009	55	MEZF8060	65	RC501	78	ASISAC	86
MEZF8005	20	T2080	31	JM2708	40	BC771C	48	MEZL4010	55	MEZF1762	65	B30212	78	ASISAR	86
MEZF473	21	T1055	32	JM3808C	40	BC72BN	48	MEZL4077	55	MEZT56059C	66	BS245S	78	CUECCG	87
MEZF8070	21	T1050	32	JM1356C	40	BC1181C	48	MEZL4001	55	MEZT56059BN	66	BS24C	78	CUESO	87
MEZF152	21	T1080	32	JM163C	40	BC1182BN	48	MEZL4033	55	MEZT56027	66	B30118	78	CUES571	87
MEZF472	21	T1070	32	JMANLA	41	BC1286C	48								

# ÍNDICE POR CÓDIGOS

CÓDIGO	PÁG	CÓDIGO	PÁG	CÓDIGO	PÁG	CÓDIGO	PÁG	CÓDIGO	PÁG	CÓDIGO	PÁG	CÓDIGO	PÁG	CÓDIGO	PÁG		
LLARAZ	96	TEEF516	100	TA1187	104	CPPR1040	109	RBCPVC1121	111	TCPVC1909	113	V3057	118	AGAL4	123	BKA425	134
LLARAVC	96	TUEI	101	REG005	104	CPPR1041	109	RBCPVC112114	111	TCPVC1910	113	V3057R	118	AGAL5	123	BKA426	134
LLARAVCR	96	TEECR112	101	REG006	104	CPPR885	109	RBCPVC2114	111	CDPE12	113	V3058	118	AGTN1399	123	BKA427	134
LLARRE	96	TEERL12	101	EC1046	104	CPPR886	109	RBCPVC2112	111	CDPE34	113	V3059	118	AGTN1400	123	BKA428	134
LLARALG	96	NIPU3838	101	EM1066	104	CPPR887	109	RBCPVC11412	111	CDPE1	113	V3059R	118	AGTN1401	123	BKA497	134
LLAR1673	96	NIPU3812	101	SGASLP02	104	CPPR1042	109	RBCPVC11212	111	LLAPPR12	113	V3060	119	AGTN1402	123	BKA948	134
LLARAER	96	NIPU516	101	SGASLP01	104	CPPR1043	109	RBCPVC11234	111	LLAPPR34	113	V3061	119	AGTN1403	123	BKA1868	135
LLAR1672	96	TAPH14	101	QCH1055	105	CPPR893	109	RBCPVC212	111	LLAPPR1	113	V3061R	119	AGTN1405	123	BKA423	135
LLAR1670	96	TAPH38	101	OCH1056	105	CPPR888	109	RBCPVC234	111	LLAPPR114	113	V3063	119	MANGN12	123	BKA1871	135
LLAR1671	96	TAPH12	101	OCH1057	105	CPPR889	109	RBCPVC21	111	LLAPPR112	113	V3063R	119	MANGN18	123	BKA1407	135
LLAR1674	96	PPR6	101	ENCPA	105	CPPR890	109	CRCPVC12	111	LLAPPR2	113	V3064	119	MANGN24	123	BKA1408	135
ABFS1911	97	PPE6	101	RPA5	105	CPPR891	109	CRCPVC34	111	LLAPPS12	113	V3064R	119	MANGN30	123	BKA1409	135
ABFM1916	97	PPR12	101	VTG1050	105	CPPR892	109	CRCPVC1	111	LLAPPS34	113	V3065	119	MANGN36	123	BKA1410	135
ABFM1915	97	PEE12	101	MTG1051	105	TPPR894	109	CCCPVC12	111	LLAPPS1	113	V3067	119	MANGN48	123	BKA1411	135
FTM1471	97	CJ38F	101	TANRB	105	TPPR988	109	CEICPVC12	111	LLAPPS114	113	VPPR1043	119	KIT1	124	BKA1412	135
FTM1472	97	NC3818	101	CGLP107	105	VPPR899	109	CEICPVC34	111	LLAPPS112	113	EMPT706	120	KIT2	124	BKA985	135
LLATM	97	TUEC38	101	CGLP108	105	VPPR890	109	CEICPVC1	111	LLAPPS2	113	EMPT707	120	KIT3	124	BKA986	135
LLAB105	97	TUEC12	101	BTG109	105	VPPR891	109	TACPV12	111	NIPV	114	ENP716	120	KIT4	124	BKA1239	135
LLAB	97	TUEC14	101	BTG110	105	JPPR892	109	TACPV34	111	V3002	114	ENP764	120	KIT5	124	BKA419	135
LLAM	97	TUEC316	101	B00TB	105	TPPR895	109	TACPV1	111	V3002R	114	EMP058	120	KIT6	124	BKA220	135
LLALMR	98	TUEC516	101	BTG111	105	TPPR896	109	TACPV12	111	V3003	114	EMPO1116	120	KIT7	125	BKA421	135
LLALMA	98	NIPT3838	101	CT12260	106	TPPR897	109	TUCPV34	111	V3003R	114	EMPO38	120	KIT10	125	BKA422	135
LLAER12MA	98	NIPT3812	101	CT12520	106	KPPR893	109	TUCPVC1	111	V3004	114	EMPO12	120	KIT14	125	BKA1240	135
LLAES12MA	98	NIPT3814	101	CT34260	106	KPPR894	109	TUCPVC114	111	V3005	114	EMPO716	120	KIT15	125	BKA983	135
LLAER14	98	NIPT1238	101	CT34520	106	CCPVC1290	110	TCPVC112	111	V3006	114	EMPO916	120	KIT11	125	BKA984	135
LLAER38	98	NIPT51614	101	CTG12	106	CCPVC3490	110	TUCPVC2	111	V3006R	114	JUEETM	120	KIT13	126	BKA1880	136
LLAER12	98	NIPT51638	101	AAI04	106	CCPVC190	110	CZCPVC1769	111	V3007	114	EMPR	120	KIT12	126	BKA1881	136
LLAER34	98	NIPT51612	101	AAI06	106	CCPVC11490	110	CZCPVC1770	111	V3007R	114	EMPO1319	120	KIT9	126	BKA1882	136
LLAER1	98	NIPC3838	101	AAI08	106	CCPVC11290	110	CZCPVC1290	111	V3010	114	EMPO1320	120	BKML1728	132	BKA1883	136
LLAER114	98	NIPC3812	101	AAI10	106	CCPVC290	110	TRBM1029	111	V3010R	114	EMPO1321	120	EXAN101	309	BKA1884	136
LLAER112	98	NIPC3814	101	AAI12	106	CCPVC1245	110	TRBM1030	111	V3011	114	EMPO1322	120	EXAN102	309	BKA1885	136
LLAER2	98	NIPC1238	101	AAI16	106	CCPVC3445	110	ARIBCPVC12	111	V3011R	114	EMPO1323	120	EXAN103	309	BKA41855	136
LLAER3	98	NIPC51614	101	AAI20	106	CCPVC145	110	ARIBCPVC34	111	V3024M	115	EMPO1324	120	EXAN104	309	BKA418AB	136
LLAER4	98	NIPC14516	101	AAI24	106	CCPVC11445	110	ARIBCPVC1	111	V3016	115	EMPO1325	120	EXAN105	309	BKA418PB	136
LLAES34	98	NIPC51638	101	AAI28	106	CCPVC11245	110	ARIBCPVC3412	111	V3016R	115	EMPO1326	120	CAT2019V	320	BKA41755	136
LLAES1	98	NIPC51612	101	AAI32	106	CCPVC245	110	ARIBCPVC112	111	V3017	115	EMPO1327	120	BKA417AB	136		
LLACR12	98	TUECR1438	102	AAI36	106	CCPVC12	110	AREBPCVC12	111	V3017R	115	EMPO1328	120	BKA417PB	136		
LLACS12	98	CODE3838	102	AAI48	106	CCPVC34	110	AREBPCVC34	111	V3022	115	EMPO1329	120	BKA973PB	137		
LLACR34	98	CODE3812	102	AAI56	106	CCPVC1	110	AREBPCVC1	111	V3021	115	EMPO1330	120	BKA973AB	137		
LLACS34	98	TUEE38	102	AAI64	106	CCPVC114	110	AREBPCVC3412	111	V3018	115	EMPO1331	120	BKA9735S	137		
LLAPBR12	98	CDEB12	102	AAI72	106	CCPVC112	110	CDC1026	111	V3018R	115	EMPO1332	120	BKA972PB	137		
LLAPBR34	98	CONPRE12	102	AAI80	106	CCPVC2	110	CDC1027	111	V3019	115	EMPO1333	120	BKA972AB	137		
LLAPBS12	98	CONPRE34	102	AAI96	106	TECPVC12	110	CDC1028	111	V3019R	115	EMPO1334	120	BKA9725S	137		
LLAPBS34	98	CONPRE1	102	ASF04	106	TECPVC34	110	CBCPVC1212	112	V3020	115	EMPO1335	120	BKA1860	137		
VB12B	98	CONPRI12	102	ASF06	106	TECPVC1	110	CRBCPVC3412	112	V3020R	115	EMPO1336	120	BKA1861	137		
VB34B	98	CPRE644	102	ASF08	106	TECPVC114	110	CRBCPVC3434	112	V3025	115	ENC0	120	BKA1862	137		
VS12B	98	CPRI665	102	ASF10	106	TECPVC112	110	CRBCPVC112	112	V3026	116	ENC00	120	BKA409M	129	BKA1863	137
VS34	98	NIPTE38	102	ASF12	106	TECPVC2	110	CRBCPVC134	112	V3027	116	ENC14	120	BKA1889	129	BKA1864	137
VTAT03	99	CDU3838	102	ASF16	106	ARECPVC12	110	CRBM1031	112	V3028	116	ENC14L	120	BKMF1012	129	BKA1865	137
VTAT04	99	CDU1414	102	ASF20	106	ARECPVC34	110	CRBM1032	112	VRC01	116	ENC38	120	BKMF1013	129	BKA975PB	137
VTAT12B	99	CDT3838	102	ASF24	106	ARECPVC1	110	CRBM1033	112	VRC02	116	ENC38L	120	BKA411M	129	BKA975AB	137
VTAT34B	99	CDT3812	102	ASF28	106	ARECPVC114	110	CRBM1034	112	VRC03	116	ENC12	120	BKA798C	130	BKA9755S	137
VCHVC12	99	NMT1060	102	ASF32	106	ARECPVC112	110	TRBCPVC112	112	V3029	116	ENC12L	120	BKA1811	130	BKA974PB	137
VCHVC34	99	NMT1061	102	ASF36	106	ARECPVC2	110	TRBCPVC3412	112	V3029R	116	ENC38M	120	BKA1803	130	BKA974AB	137
VCHVL12	99	NMT1659	102	BPA1678	107	ARICPVC12	110	TRBCPVC134	112	V3031	116	CENC711	120	BKA796C	130	BKA9745S	137
VCHVL34	99	NMT1234	103	BPA1679	107	ARICPVC34	110	LLARCPVC12	112	V3031R	116	CENP710	120	BKA698M	130	BKA1802	130
PICH34B	99	NMT341	103	BPA1680	107	ARICPVC1	110	LLALCPVC12	112	V3032	116	ALIM40MA	121	BKA1802	130	BKMF1015	130
PICH1B	99	CDRI12	103	BPA1681	107	ARICPVC114	110	LLALCPVC12	112	V3032R	116	ALIM55MA	121	BKA1800	130	BKA1800	130
PICH114B	99	CDRI34	103	CGR03	107	ARICPVC112	110	LLATCPVC34	112	V3033	117	ALIM1MA	121	BKA1890	130	BKA1801	130
PICH112B	99	CDRE12	103	CG9KG	107	ARICPVC2	110	LLATCPVC1	112	V3033R	117	ALISM40	121	BKA1801	131	MP0001	139
PICH2B	99	CDRE34	103	CGS9KG	107	TRCPVC3412	110	JECPVC12	112	V3034	117	ALISM55	121	BKML1010	131	MP0002	139
PICHAC12	99	REDB3412B	103	CPPR863	108	TRCPVC112	110	VBCPVC12	112	V3034R	117	ALIL214	121	BKML1011	131	MP0010	139
PICHAC34	99	NIBR1788	103	CPPR864	108	TRCPVC134	110	VBCPVC34	112	V3036	117	ALIL213	121	BKML1011	131	MP0003	139
PICHAC1	99	NIBR1789	103	CPPR865	108	TRCPVC11434	110	VBCPVC1	112	V3036R	117	ALIS216	121	BKA402M	131	MP0004	139
PICHAC114	99	NIBR1790	103	CPPR866	108	TRCPVC1141	110	VBCPVC114	112	V3037	117	ALIS215	121	BKA405M	131	MP0005	139
PICHAC112	99	NIBR1791	103	CPPR867	108	TRCPVC1121	110	VBCPVC112	112	V3037R	117	ALILV40	121	BKA406M	131	MP0006	139
PICHAC2	99	NIBR1792	103	CPPR868	108	TRCPVC112114	110	VBCPVC2	112	V3038R	117	ALILV55	121	BKA401M	131	MP0007	139
TM1638	99	RBBR1793	103	CPPR872	108	TRCPVC2114	110	TRCPVC312	110	V3038	117	ALISV40	121	BKML1014	131	MP0011	139
TM1640	99	RBBR1794	103	CPPR873	108	TRCPVC2112	110	TCPVC334	113	V3039	117	ALISV55	121	BKMB1008	131	PEG112	140
ODB12	99	RBBR1795	103	CPPR860	108	GCPVC12	110	TCPVC31	113	V3039R	117	ALILTM	121	BKMB1009	132	PEG113	140
ODB34	99	RBBR1796	103	CPPR861	108	GCPVC34	110	TCPVC3114	113	V3041	117	MBA1212	122	BKA407M	132	PEG114	140
ODB1	99	RBBR1797	103	CPPR862	108	GCPVC1	110	TCPVC3112	113	V3041R	117	MBA3412	122	BKA1799	132	PEG115	140
VCH448	99	RBBR1798	103	CPPR876	108	GCPVC114	110	TCPVC32	113	V3043	117	MBA3434	122	BKA797C	132	PEG116	140
VCH449	99	CONRE12	103	CPPR877	108	GCPVC112	110	TCPVC612	113	V3043R	117	MBA666	122	BKA699M	132	PEG122	140
VCH980	99	CONRE34	103	CPPR878	108	GCPVC2	110	TCPVC634	113	V3045	117	MBA667	122	BKA1804	132	PEG123	

# ÍNDICE POR CÓDIGOS

CÓDIGO	PÁG	CÓDIGO	PÁG	CÓDIGO	PÁG	CÓDIGO	PÁG	CÓDIGO	PÁG	CÓDIGO	PÁG	CÓDIGO	PÁG	CÓDIGO	PÁG		
LIM127	140	CHUM58	147	SHTP2022	152	644255	157	T2014C	163	SZAE1915	168	C5065	172	JE160N	178	J642N	180
LIM128	140	CHUM34	147	SHTP2024	152	644155	157	T2014AB	163	SZAF1917	168	C5065L	172	J1244N	178	J643N	180
LIM129	140	CHUM1	147	SHTP2025	152	980755	157	T201455	163	SZAF1920	168	C8565	172	J1254A	178	J732N	180
TL136	140	MPB1735	148	SHTP2026	152	980855	157	T2014D	163	SZAF1918	168	C8575	172	J1255A	178	J998C	180
TL137	140	MPB1736	148	SHTP2023	152	SHCE2070	157	TPPLD	163	SZAF1919	168	C4555	172	J1256A	178	J999C	180
CPLAS1L	140	MPB1737	148	SHP2027	153	SHCE2068	157	TPPL55	163	SZAF1921	168	C4565	172	J1257A	178	J501N	180
CPLAS4L	140	MPB1738	148	SHP2028	153	SHCE2069	157	TPPC708	163	SZAF1923	168	C5500	172	J1258A	178	J504N	180
CSEAL4L	140	MPB1739	148	SHP2029	153	7312PB	158	SP1016	163	SZAF1922	168	CBC1065CM	173	J1259A	178	J503N	180
CSEAL19L	140	MPB1740	148	SHP2030	153	7312AB	158	MIRPD	163	SZAF1924	168	CBC665CM	173	J1260A	178	J733N	180
IMP1683	141	MPB1741	148	SHP2031	153	731255	158	MIRPH	163	SZAV1944	168	C6040M	173	J1261A	178	J527N	180
IMP19L	141	MPB1742	148	SHP2032	153	7301PB	158	MIRPS	163	SZAV1945	168	CCL1118	173	J1951A	178	J806D	181
IMP643	141	MPB1743	148	SHP2033	153	7301AB	158	TC583	164	SZAV1946	168	CC1121	173	J1952A	178	J806N	181
IMP19LFR	141	MPB1744	148	SHP2034	153	730155	158	TC582	164	SZCE1947	168	CC100CM	173	J1953A	178	J734D	181
IMP1685	141	MPB1745	148	SHCV2039	153	PCECSD	158	BC585	164	SZCE1948	168	B244AH	174	J742N	178	J734N	181
IMP645	141	MPB1746	148	SHCV2040	153	PCECSS	158	BC584	164	SZBS1908	168	B244BH	174	J743N	178	J245BH	181
MPTC1686	141	MPB1747	148	SHEM2035	153	PCECSS	158	SC1015	164	SZBS1909	168	B244MD	174	J744N	178	J245AH	181
MPTC1687	141	MPB1748	148	SHEM2036	153	PCECD	158	SC1014	164	SZBS1910	168	B244BD	174	J735N	178	J245D	181
IMP7981	141	MPB1749	148	SHEM2037	153	PCECDH	158	PERP50	164	SZBS1911	168	B244AD	174	J736N	178	J245AD	181
MPTF1684	141	MPB1750	148	SHEM2038	153	PCECD5	158	PERP50AB	164	SZBS1912	169	B752D	174	J737N	178	J245MD	181
MPTF1685	141	MPB1751	148	SHTP2041	153	PCMCD5	158	CM574	164	SZBS1913	169	B753N	174	J738N	178	J727D	181
IMP7977	141	MPB1752	148	SHTP2042	153	PCMCSH	158	CM577	164	SZBM1940	169	B344N	174	J754N	179	J728N	181
IMP1352	141	MPB1753	148	SHTP2043	153	PCMCS5	158	CM578	164	SZBM1942	169	B344H	174	J755N	179	J729D	181
CI1778	142	MPB1754	148	SHNC2044	153	PCMCD	158	CM579	164	SZBM1943	169	B344D	174	J756N	179	J1810N	181
BI1777	142	MPB1755	148	SHNC2045	153	PCMCDH	158	CM580	164	SZBM1923	169	B751N	174	J757N	179	J729H	181
PCA1059	142	MPB1756	148	SHNC2046	153	PCMCD5	158	CM581	164	SZBM1924	169	B328	174	J758N	179	J320D	181
CRM1240	142	MPB1757	148	SHNC2047	153	PC64315	159	G607C	165	SZBM1928	169	B750D	174	J759N	179	J320H	181
CRM1239	142	RP14100	148	SHNC2048	153	PC64325	159	G608N	165	SZBM1929	169	B114D	174	J1440N	179	J320N	181
EPME855	142	RP38100	148	SHNC2049	153	PC64415	159	G605C	165	SZBM1925	169	B110H	174	J1441N	179	J2131D	181
EPME854	142	RP516100	148	SHNC2050	153	PC64425	159	G606N	165	SZBM1926	169	B748D	174	J1442N	179	J2135H	181
PBP858	142	DA43V	148	SHNC2051	153	PC14245	159	NCB03	165	SZBM1927	169	B749H	174	J1443N	179	J1969N	182
PBP857	142	DA44V	148	SHNC2052	153	PC14255	159	NCB13	165	SZBM1930	169	B745N	174	J1444N	179	J1247N	182
PBP906	142	DA46V	148	SHP2054	153	2391DI	160	NCB23	165	SZBM1931	169	B746H	174	J1445N	179	J1248N	182
PAP1873	142	DA48V	148	SHP2055	153	2391DD	160	NCB33	165	SZBM1932	169	B746D	174	J1446N	179	J1249N	182
PAP1874	142	SAE1L	148	3881PB	154	2391FI	160	NCB43	165	SZBM1933	169	B6144BN	175	J1447N	179	J502N	182
PA1881	142	AL5519	148	3881AB	154	2391FD	160	NCB53	165	SZBM1934	169	B6144D	175	J1448N	179	J4333	182
PA1880	142	PD5255	148	38815S	154	CF1361	160	NCB63	165	SZBM1935	169	B802D	175	J621N	179	J365N	182
PA1879	142	ES5284	148	3891PB	154	CFD360	160	NCB73	165	SZBM1936	169	B405N	175	J622N	179	J1267N	182
PA1878	142	ID5324	148	3891AB	154	CLE641	160	NCB83	165	SZBM1937	169	B401N	175	J623N	179	J14D	182
PA1877	142	DREEC	149	38915S	154	22240D	161	NCB93	165	SZBM1938	169	B1265H	175	J624N	179	J1266N	182
PA1882	142	NTTG663	149	805872PB	154	C12220C	161	NCB06	165	SZBM1939	169	B505BN	175	J625N	179	J730D	182
PA1883	142	NTTG662	149	805872AB	154	C10316	161	NCB16	165	SZBM1941	169	B647N	175	JTH898	179	J731D	182
PB953	142	GAR14	149	8058725S	154	C10320	161	NCB26	165	SHC1987	170	B270N	175	JTH899	179	J726H	182
PB952	142	GAR38	149	806872PB	154	C10325	161	NCB36	165	SHC1988	170	B391N	175	JTH900	179	J1269H	183
PB951	142	GAR516	149	806872AB	154	C10330	161	NCB46	165	SHC1989L	170	B723N	175	JTH901	179	J1270H	183
PB950	142	TPB38	149	8068725S	154	CF379	161	NCB56	165	SHC1990L	170	B724N	175	J776136	179	J1262ND	183
PB976	142	TPB14	149	801872PB	154	CF376	161	NCB66	165	SHC1986	170	B725N	175	J796150	179	J1263ND	183
PB1875	142	GARE14	149	801872AB	154	CF377	161	NCB76	165	C3020	170	B600N	175	JT128188	179	J104D	183
PB1876	142	NPB14	149	8018725S	154	SHCC1989	161	NCB86	165	C3025	170	B500N	175	JT160230	179	J100H	183
MPPR1974	309	NPB38	149	8202PB	154	SHCC1990	161	NCB96	165	C3032	170	B1023N	176	JT277337	179	J108N	183
CPB14	149	8202AB	154	SHCC1991	161	NCA04	165	C3038	170	B408N	176	JT450510	179	J380D	183		
CPB38	149	82025S	154	CF380	161	NCA14	165	C3050	170	B633N	176	JT477537	179	J380H	183		
TEPB14	149	8093PB	155	CF381	161	NCA24	165	C3525	170	B631N	176	JT595655	179	J24D	183		
TEPB38	149	8093AB	155	CF382	161	NCA34	165	C3532	170	B632N	176	JT860920	179	J24H	183		
		80935S	155	CF383	161	NCA44	165	C3538	170	B407N	176	J601N	179	J204D	183		
		803872PB	155	PASDA07	162	NCA54	165	C3550	170	B1428	176	J602N	179	J200H	183		
		803872AB	155	PAS507	162	NCA64	165	CHL1183	170	B1429	176	J603N	179	BIS0716	184		
		8038725S	155	PASSLD	162	NCA74	165	CHL1184	170	B1430	176	J604N	179	BIS0717	184		
		8101PB	155	PASSLH	162	NCA84	165	CHL1185	170	B1427	176	J606N	179	BIS0718	184		
		8101AB	155	P828PB	162	NCA94	165	CHL1186	170	JAE1961	177	J608N	179	BIS0719	184		
		81015S	155	P8285S	162	SHPM1998	166	CF232	170	JAE1984	177	J1017N	179	BIS0720	184		
		80835S	155	PALT212	162	SHPM1990	166	CF238	170	JAE1983	177	J1018N	179	BIS0721	184		
		80835D	155	PALT414	162	SHPM1992	166	CF250	170	JAE1962	177	J1019N	179	BIS0713	184		
		8103PB	155	PALTS12	162	SHPM1997	166	CF263	170	J611N	177	J1426N	179	BIS0714	184		
		8103AB	155	PACR212	162	SHPM1996	166	CM1700	171	J612N	177	J1020N	179	BIS0715	184		
		8206PB	155	PACR414	162	SHPM1991	166	CM1701	171	J613N	177	J1970N	179	BIS090	185		
		8206AB	155	PACRS12	162	SHPM1993	166	CM1702	171	J614N	177	J1971N	179	BIS0135	185		
		82065S	155	PC212	162	SHPM1999	166	CM1703	171	J615N	177	J1972N	179	BIS0165	185		
		8872PB	156	PC312	162	SHPM1994	166	CM1704	171	J617N	177	J1250N	179	BISO	185		
		8872AB	156	PC412	162	SHPM1995	166	CM1705	171	JA1004	177	J1251N	179	BIS0944	185		
		88725S	156	PC6	162	SHPM2001	167	CM1706	171	JA1005	177	J1000A	179	BISBL	185		
		8871PB	156	PESP1773	162	SHPM2000	167	CM1707	171	JA1006	177	J1432A	179	BISBR	185		
		8871AB	156	PESP1774	162	SHPM2004	167	CL7130	171	JA1007	177	J1433A	179	BISBR945	185		
		88715S	156	PESP1775	162	SHPM2005	167	CL7140	171	JA1008	177	J1001A	179	BISPP46	185		
		6452PB	156	PESP1776	162	SHPM2002	167	CL7150	171	J739N	177	J1002A	179	SHPB1949	185		
		6452AB	156	PP4A	162	SHPM2003	167	CL7130L	171	J740N	177	J1003A	179	SHPA1988	185		
		64525S	156	PP6A	162	SHPM1946	167	CL7140L	171	J741N	177	J1246N	179	BP2517AN	186		
		6451PB	156	2900D	162	SHPM1947	167	CL7150L	171	J1241N	177	JN1950	180	BP3823AN	186		
		6451AB	156	2900I	162	SHPM1948	167	CL27140	171	J1242N	177	J3770S	180	BP4828AN	186		

# ÍNDICE POR CÓDIGOS

CÓDIGO	PÁG	CÓDIGO	PÁG	CÓDIGO	PÁG	CÓDIGO	PÁG	CÓDIGO	PÁG	CÓDIGO	PÁG	CÓDIGO	PÁG	CÓDIGO	PÁG		
BP3H	186	JRE1426	188	TVPB12B	191	TBR12212	192	SHPC1945	194	TPSG1DBB	201	TPPE1155	208	TPRM8W	213	TPS8B10	215
BP3N	186	JRE1427	188	TVPB34B	191	TBR123	192	SHPC1946	194	TPDM474	201	TPPE1156	208	TPRM16W	213	TPSB1012	215
BP312D	186	JRE1424	188	TVPB1B	191	TBR141	192	SHPC1949	194	TPRA476	201	TPPT1153	208	TPRM24W	213	TPSB1214	215
BP312H	186	JRE1425	188	TVPB114B	191	TBR14112	192	SHPC1947	194	TPFS477	201	TPPT1154	208	TPMR1106	213	TPMR1917	215
BP312N	186	JRE1423	188	TT34	191	TBR142	192	SHPC1948	194	TPAT102	202	TPVO10	208	TPMR1107	213	TPMR1923	215
BPA3DP	186	JRE722	188	TT1	191	TBR14212	192	RNE40	194	TPAT1120G	202	TPVO12	208	TPMR596	213	TPMR1935	215
BPA3HP	186	JRE723	188	TT114	191	TBR143	192	RNE50	194	TPEG	202	TPVO14	208	TPMM595	213	TPMR1929	215
BPA3NP	186	JRE724	188	TT112	191	TB112PC	192	RNPE40	194	TPAHRK6	202	TPWG2	208	TPMB1100	213	TPMR1918	215
BPA312DP	186	JRE725	188	TT158	191	TB114PC	192	RNPE50	194	TPTC1	202	TPLSF333	208	TPMB1101	213	TPMR1919	215
BPA312HP	186	JRE726	188	TT2	191	TB112PB	192	RNP40	194	TPB327	202	TPAHP	208	TPMB1102	213	TPMR1920	215
BPA312NP	186	SHPG1963	189	TT212	191	TB114PB	192	RNP50	194	TPMP1137	202	TPWHA	208	TPMB1103	213	TPMR1921	215
BPA4DP	186	SHBT1964	189	TT3	191	TK812C	192	RBP640	194	TPMP1136	202	TPW1810	208	TPMB1104	213	TPMR1922	215
BPA4HP	186	SHBT1965	189	TT312	191	TK834C	192	RBP650	194	TPDHTC	202	TPHA1361	209	TPMM488	213	TPMR1930	215
BPA4NP	186	SHBT1966	189	TT4	191	TK81C	192	RBP40	194	TPDFTG160	202	TPHA1360	209	TPMU489	213	TPMR1931	215
BP35S	187	SHCT1967	189	TT834	191	TK812B	192	RBP50	194	TP185	202	TPHA1362	209	TPH16T	213	TPMR1932	215
BP3125S	187	SHCT1968	189	TT81	191	TK834B	192	TPNEED100	202	TPHA1363	209	TPH20T	213	TPMR1933	215		
BP45S	187	SHAM1950	189	TT8114	191	TK81B	192	<b>TRUEPOWER</b>		TPSG1LK	203	TPHA1364	209	TPMT312	213	TPMR1934	215
BP212D	187	SHAM1952	189	TT8112	191	TJ34C	192	<b>CÓDIGO</b>	<b>PÁG</b>	TPSG1DBK	203	TPHA1365	209	TPM283	213	TPMR1924	215
BP212N	187	SHAM1953	189	TT8158	191	TJ78C	192	TPSGG14CK	203	TPHA1366	209	TPM284	213	TPMR1925	215		
BP35	187	PE569	189	TT82	191	TJ1C	192	TP1262	197	TPCPB1861	203	TPPT325	209	TPM285	213	TPMR1926	215
BP312S	187	PE426	189	TT34K2	191	TJ118C	192	TP1263	197	TPCPB1860	203	TPPT326	209	TPM286	213	TPMR1927	215
BP2D	187	PE427	189	TT11K2	191	TJ114C	192	TP1264	197	TPCPB1859	203	TPPT463	209	TPM287	213	TPMR1928	215
BP2H	187	SHBR1987	189	TT114K2	191	TJ112C	192	TP1250	197	TPLLB1865	203	TPCLR100MC	209	TPM288	213	TPMR1912	215
BP2N	187	SHBR1959	189	TT112K2	191	TJ158C	192	TP1251	197	TPLLB1864	203	TPPC1273	209	TPM289	213	TPMR1913	215
BDAD3	187	SHBR1960	189	TT158K2	191	TJ134C	192	TP1252	197	TPLLB1863	203	TPCM1272	209	TPM290	213	TPMR1914	215
BDAD3N	187	TB12CH	190	TT2K2	191	TJ34B	192	TP1253	197	TPHP300T	203	TPLB1271	209	TPM291	213	TPMR1915	215
BISPB	187	TB12CD	190	TT212K2	191	TJ78B	192	TP1254	197	TPFT100M	203	TPLL334	210	TPMM441	213	TPMR1916	215
BISPBH	187	TB12CA	190	TT3K2	191	TJ1B	192	TP1255	197	TPHP20112C	203	TPLL335	210	TPMM442	213	TPSS25	215
BISPB5	187	TB58CD	190	TT312K2	191	TJ118B	192	TP1256	197	TPB5M05	203	TPLL336	210	TPMTB1435	214	TPSS30	215
BISPBC	187	TB58CH	190	TT4K2	191	TJ114B	192	TP1240	197	TPBM20138	203	TPLL337	210	TPMTB1436	214	TPSS40	215
BISPBN	187	TB58CA	190	TT834K2	191	TJ112B	192	TP1241	197	TPBM1857	203	TPLL338	210	TPMTB1437	214	TPSS50	215
SHBP2006	187	TB12MH	190	TT81K2	191	TJ158B	192	TP1242	197	TPB356	203	TPLL339	210	TPMTB1438	214	TPSS60	215
SHBP2007	187	TB12MD	190	TT8114K2	191	TJ134B	192	TP1243	197	TPEUR592	204	TPFE346	210	TPMTB3G	214	TPSS75	215
SHBP2008	187	TB12MA	190	TT8112K2	191	SHTT2067	193	TP1244	197	TP9040A	204	TPFE568	210	TPTB4G	214	TPPH4	215
BISPGD	187	TB58MD	190	TT8158K2	191	SHTS2071	193	TP1220	197	TPF50A	204	TPCA292	210	TPTB5G	214	TPPH6	215
BISPGH	187	TB58MH	190	TT82K2	191	JG05516	193	TP1221	197	TPGR14	204	TPCA293	210	TPTB6G	214	TPPH8	215
BISPGS	187	TB58MA	190	TA12C	191	JG0514	193	TP1222	197	TPGR516	204	TPCA294	210	TPNC413	214	TPPH10	215
BISPGC	187	TM712C	190	TA34C	191	R1840	193	TP1223	197	TPGR38	204	TPCA295	210	TPCM411	214	TPSH4	215
BISPGN	187	TLM114C	190	TA1C	191	R1950	193	TP1224	197	TPGR12	204	TPV385	210	TPCM412	214	TPSH6	215
JRL1275C	188	TLM112C	190	TA114C	191	R2060	193	TP1225	197	TPGR916	204	TPR384	210	TPCC3HD	214	TPSH8	215
JRL1276C	188	TLM2C	190	TA112C	191	R2280	193	TP1226	197	TPCN1071	204	TPEAM482	211	TPCC4HD	214	TPSH10	215
JRL1277C	188	TLM212C	190	TA158C	191	R22100	193	TP1227	197	TPCN1072	204	TPEAM483	211	TPCC4HD	214	TPBMP14	216
JRL1278C	188	TLM83C	190	TA12B	191	R23120	193	TP1228	197	TPCN1073	204	TPEAM484	211	TPCC8HD	214	TPBMP516	216
JRL1279C	188	TLM141C	190	TA34B	191	R23150	193	TP1229	197	TPCN1074	204	TPEAM485	211	TPPS599	214	TPBMP38	216
JRL1292	188	TLM14114C	190	TA1B	191	AA1530	193	TP1230	197	TPCN1075	204	TPEAM486	211	TPPS597	214	TPBMP716	216
JRL14	188	TLM14112C	190	TA114B	191	AA1740	193	TP1231	197	TPCN1076	204	TPEAM487	211	TPPS598	214	TPBMP12	216
JRL16	188	TLM142C	190	TA112B	191	AA1850	193	TP1232	197	TPCN1077	204	TPPK1	211	TPCR613	214	TPBMP916	216
JRL18	188	TLM14212C	190	TA158B	191	AA1960	193	TP1233	197	TPCN1078	204	TPPK2	211	TPFM14	214	TPBMP58	216
JRL20	188	TLM143C	190	TTFPB1	191	AA2070	193	TPAC224	198	TPCN1079	204	TPPK3	211	TPFM38	214	TPBMP34	216
JRL22	188	TLM114B	190	TTFPB114	191	AA2180	193	TPAC2510	198	TPCN1080	204	TPPK4	211	TPFM12	214	TPBMP78	216
JRL24	188	TLM112B	190	TTFPB112	191	AA2290	193	TPAC220V	198	TPCN1081	204	TPPK5	211	TPFM58	214	TPBMP1	216
JRE1712	188	TLM2B	190	TTFPB2	191	AA22100	193	TPAC325	198	TPGN1082	204	TPJE600	211	TPFM34	214	TPBMP118	216
JRE1714	188	TLM212B	190	TTFPB1K2	191	AA23110	193	TPCP1116	199	TPGN1083	204	TPEP601	211	TPFM78	214	TPBMP114	216
JRE1716	188	TLM83B	190	TTFPB114K2	191	AA24120	193	TPPA518B	199	TPGN1084	204	TPEP602	211	TPFM1	214	TPBMP112	216
JRE1718	188	TLM141B	190	TTFPB112K2	191	AA25130	193	TPJA1161	199	TPGN1085	204	TPEP603	211	TPFM114	214	TPB316	216
JRE1720	188	TLM14114B	190	TTFPB2K2	191	AA25150	193	TPAA471	199	TPGN1086	204	TPSCRPB	211	TPFM112	214	TPBV14	216
JRE2712	188	TLM14112B	190	TTF1	191	AC1530	193	TPRH1425E	199	TPGN1087	204	TPCM612	211	TPCS14	214	TPBV516	216
JRE2714	188	TLM142B	190	TTF114	191	AC1740	193	TPRH1450E	199	TPGN1088	204	TPCF1214	211	TPCS15	214	TPBV38	216
JRE2716	188	TLM14212B	190	TTF112	191	AC1745	193	TPAH3825Y	199	TPGN1089	204	TPCF1215	211	TPCS16	214	TPBV12	216
JRE3010	188	TLM143B	190	TTF2	191	AC1850	193	TPAH3850Y	199	TPGN1090	204	TPCF1216	211	TPCS17	214	TPCHU916	216
JRE3012	188	TM712B	190	TTF1K2	191	AC1960	193	TPAH38100Y	199	TPGN1091	204	TPCM1217	211	TPCS18	214	TPCHU114	216
JRE3014	188	TPB1234C	190	TTF114K2	191	AC2070	193	TPPS475	199	TPHT	205	TPCM1218	211	TPCS19	214	TPJBM590	216
JRE3016	188	TPB121C	190	TTF112K2	191	AC2290	193	TPPS1162	199	TPDP1163	205	TPCM1765	211	TPCS20	214	TPHS13BM	216
JRE3018	188	TPB12114C	190	TTF2K2	191	AC22100	193	TPABG	199	TPTUB10	205	TPCM1766	211	TPCS21	214	TPLIK3	216
JRE1414	188	TPB12112C	190	TB112C	192	AC23110	193	TPQCS4	200	TPTUB16	205	TPCM1767	211	TPCS22	214	TPBH578	216
JRE1415	188	TPB34C	190	TB114C	192	AC24120	193	TPJC564	200	TPHT5	205	TPCM179	211	TPCS23	214	TPBH51	216
JRE1416	188	TPB1C	190	TB112B	192	AC25130	193	TPQCS5	200	TPHT10	205	TPCM178	211	TPCS45	215	TPBH5114	216
JRE1417	188	TPB14114C	190	TB114B	192	AC25150	193	TPJC565	200	TPAT16	205	TPCM180	211	TPSC56	215	TPBH5112	216
JRE3510	188	TPB112C	190	TV12C	192	TQA14	193	TPQCS5B	200	TPPL779	205	TPRA609	212	TPSC68	215	TPBH5134	216
JRE3512	188	TPB2C	190	TV34C	192	TQA38	193	TPCOPM	200	TPAT164	205	TPCV407	212	TPSC810	215	TPBH52	216
JRE3514	188	TPB212C	190	TV1C	192	TQA12	193	TPCRM560	200	TPCR778	205	TPCD1160	212	TPSC1012	215	TPBH5218	216
JRE3516	188	TPB3C	190	TV114C	192	T5553	193	TPCOPF	200	TP1065	205	TPEC607	212	TPSC1214	215	TPBH5214	216
JRE3518	188	TPB1234B	190	TV112C	192	T5554	193	TPCRF561	200	TP1003	205	TPEC608	212	TPSG45	215	TPBH5212	216
JRE3520	188	TPB12															

# ÍNDICE POR CÓDIGOS

CÓDIGO	PÁG	CÓDIGO	PÁG	CÓDIGO	PÁG	CÓDIGO	PÁG	CÓDIGO	PÁG	CÓDIGO	PÁG	CÓDIGO	PÁG	CÓDIGO	PÁG	CÓDIGO	PÁG
TPSOK18	218	TPLPM529	224	TPW9DW	227	TP219	229	TPEPG1	232	TPL1220	235	TPJP1174	242	TPDB1014	245	TPH440	248
TPNR1458	218	TPLPM530	224	TPW40T	227	TP214	229	TPGOGGLE	232	TPL1418	235	TPPB176	242	TPDB101764	245	TPH112FV	248
TPNR1459	218	TPLPM531	224	TPW412DT	227	TP220	229	TPG51119	232	TPL1420	235	TPPB177	242	TPDB10932	245	TPH400	248
TPNF509	218	TPLPE532	224	TPW70T	227	TP221	229	TPG51120	232	TPL1220	235	TPPB175	242	TPDB5516	245	TPTP787	248
TPNP508	218	TPLPE533	224	TPW9DT	227	TP222	229	TPPL606	232	TPL2020	235	TPDBFP214	242	TPDB538	245	TPTH387	248
TPNP510	218	TPLPE534	224	TPW4DD	227	TP223	229	TPLT340	232	TPL1824	235	TPDBPH1	242	TPDB5716	245	TPZ386	248
TPRNS11	218	TPLPE535	224	TPW412DD	227	TP224	229	TPLT341	232	TPL2030	235	TPJP1172	242	TPDB512	245	TPTM979	248
TPRNS12	218	TPLM536	224	TPW7DD	227	TP225	229	TPLT342	232	TPL2040	235	TPH310	243	TPMDB51844	245	TPTM434	248
TPUKF	218	TPLM537	224	TPW9DD	227	TP226	229	TPLT343	232	TPL2041	235	TPH311	243	TPMDB53164	245	TPZM433	248
TPUK03	218	TPLM538	224	TPCOW4	227	TP227	229	TPLP169	232	TPLR57	235	TP184	243	TPMDB53166	245	TPM435	248
TPUK2	218	TPLM539	224	TPCOW412	227	TP227	229	TPLP168	232	TPLR68	235	TPLM610	243	TPMDB5384	245	TPMB1938	249
TPAS1140	219	TPLR540	224	TPCOW778	227	TP228	229	TPSHTR	232	TPLR658	235	TPLM611	243	TPMDB5386	245	TPMB1937	249
TPMA375	219	TPLR541	224	TPCOW758	227	TP229	229	TPSHBT	232	TPLR810	235	TPLA409	243	TPMDB5126	245	TPMC1939	249
TPCOP55	219	TPLR542	224	TPCOW14	227	TP236	229	TPSHTY	232	TPLR1010	235	TPLA410	243	TPMDB51412	245	TPMG1940	249
TPS8800	219	TPLR543	224	TPDGW7H	227	TP237	229	TPSHTW	232	TPLR1012	235	TPDP493	243	TPMDB551612	245	TPMR1955	249
TPS8801	219	TPLR550	224	TPCOW416	227	TP238	229	TPSHTO	232	TPLR1013	235	TPTKW8	243	TPMDB53812	245	TPMR1954	249
TPHFCE	219	TPLT551	224	TPCOW41216	227	TP239	229	CBPE	232	TPLR1016	235	TPHKW95	243	TPMDB51212	245	TPMM1952	249
TPHF2	219	TPLT552	224	TPDGW4	227	TP240	229	CBPR	232	TPLR1216	235	TPHKW9M	243	TPMDB4P	245	TPMP1953	249
TPASMR12	219	TPLR547	224	TPDGW412	227	TP241	229	CBPP	232	TPLR1316	235	TPDB7H	245	TPDP492	243	TPMM1949	249
TPA355	219	TPLT548	224	TPCOW778M	227	TP242	229	TPMASH50B	232	TPLR1319	235	PTHT22	243	TPDB13H	245	TPMM1950	249
TP183	219	TPLT549	224	TPCOW758M	227	TP243	229	TPTA557	232	TPLR1820	235	TPDJ153	243	TPD144	246	TPMM1951	249
TP182	219	TPGSW6	225	TP186	227	TP244	229	TPDMSG3	232	TPLR2020	235	TP1091	244	TPD145	246	TPMM1946	249
TPETC7	219	TPSTONE9A	225	TP187	227	TP245	229	TPGN313	233	TPLR2030	235	TP1092	244	TPD146	246	TPMM1947	249
TPTC16P	219	TPBG6	225	TP1070	227	TP246	229	TPGN314	233	TPS201	236	TP1093	244	TPD147	246	TPMM1948	249
TPCT165	219	TPMMS5	225	TP1071	227	TP247	229	TPGN315	233	TPS202	236	TP1094	244	TPD148	246	TPMH1942	249
TPPTC4	220	TPMMS10	225	TP1072	227	TP248	229	TPGP1034	233	TPS203	236	TP1095	244	TPD149	246	TPMH1941	249
TPTUBC114Q	220	TPSTONE6	225	TP1073	227	TP249	229	TPGP1035	233	TPS204	236	TP1096	244	TPD136	246	TPMM1944	249
TPMTC	220	TPSTONE8	225	TP1074	227	TP230	229	TPGP1036	233	TPS205	236	TP1097	244	TPD137	246	TPMM1943	249
TPPCP158	220	TPLR928	225	TP1075	227	TP232	229	TPGD1688	233	TPS206	236	TP1098	244	TPD138	246	TPMM1945	249
TPPC2	220	TPLR929	225	TP1076	227	TP233	229	TPGD1689	233	TPS278	236	TP1099	244	TPD139	246	TPAZ15L	250
TPTUBC118B	220	TPLR930	225	TP1077	227	TP234	229	TPGD1690	233	TPS207	236	TP1170	244	TPD140	246	TPAZ275L	250
SEPP18	220	TPLA925	225	TP1078	227	TP235	229	TPGD1691	233	TPS279	236	TP1171	244	TPD141	246	TPMA1936	250
SEPP316	220	TPLA924	225	TP1079	227	TP250	229	TPGV1692	233	TPS209	236	TP1172	244	TPD142	246	TPMA556	250
SEPP14	220	TPLA923	225	TP1080	227	TP251	229	TPGV1693	233	TPS209	236	TP1173	244	TPD143	246	TPMA557	250
SEPP516	220	TPLA922	225	TP1081	227	TP252	229	TPGI1686	233	TPS210	237	TP1174	244	TPD122	246	TPMA558	250
SEPP38	220	TPLA921	225	TPDC248	228	TP253	229	TPGI1687	233	TPS211	237	TP1175	244	TPD123	246	TP105	250
SEPP12	220	TPLA920	225	TPDC2548	228	TP254	229	TPGC774	233	TPS212	237	TP1176	244	TPD124	246	TP106	250
TPBK7	220	TPLA919	225	TPDC348	228	TP255	229	TPGC775	233	TPS190	237	TP1177	244	TPD125	246	TP107	250
TPC296	221	TPLA918	225	TPDC3548	228	TP256	229	TPGC776	233	TPS192	237	TP1178	244	TPD126	246	TP101	250
TPC297	221	TPLA917	225	TPDC448	228	TP257	229	TPGC777	233	TPS191	237	TP1179	244	TPD127	246	TP102	250
TPC298	221	TPLA916	225	TPDC548	228	TP258	229	TPGA1037	233	TPS280	237	TP1180	244	TPD128	246	TP103	250
TPC299	221	TPLA915	225	TPDC216	228	TP259	229	TPGA1039	233	TPS193	237	TP1181	244	TPD129	246	TP104	250
TPC300	221	TPLA914	225	TPDC2545	228	TP260	229	TPGA1038	233	TPS194	237	TP1182	244	TPD130	246	TPB1068	250
TPC301	221	TPLA913	225	TPDC320	228	TPCH1205	230	CFV2250	234	TPS195	237	TP1183	244	TPD131	246	TPMP786	250
TPC308	221	TPLA912	225	TPDC3555	228	TPCH1207	230	CFV150	234	TPS216	239	TP1184	244	TPD132	246	CSTD621	251
TPC309	221	TPLA911	225	TPDC460	228	TPCH1209	230	CT1215	234	TPS217	239	TP1185	244	TPD133	246	CSTD622	251
TPW612C	221	TPLA910	225	TPDC426	228	TPCH1211	230	CT2250	234	TPS218	239	TP1186	244	TPD134	246	CSTD623	251
TPC302	221	TPLR1291	225	TP265	228	TPCH1206	230	CT2500	234	TPS219	239	TP1187	244	TPD135	246	CSTD624	251
TPC303	221	TPLR935	225	TP266	228	TPCH1208	230	CA210	234	TPS220	239	TP1188	244	TPD109	246	CSTD625	251
TPC304	221	TPLR934	225	TP267	228	TPCH1210	230	CA230	234	TPS221	239	TP1189	244	TPD110	246	CSTD626	251
TPC305	221	TPLR933	225	TP268	228	TPCH1212	230	CA12	234	TPS222	239	TP1190	244	TPD111	246	CSTD627	251
TPC306	221	TPLR932	225	TP269	228	TPFE418	230	CAN5	234	TPS223	239	TP1191	244	TPD112	246	CSTD628	251
TPC307	221	TPLR931	225	TP270	228	TPFE419	230	CAN5	234	TPS224	239	TP1192	244	TPD113	246	CSTD629	251
TPWB5319L	222	TPLR1293	225	TP271	228	TPFE420	230	CIP2	234	TPSS52B	240	TP1193	244	TPD114	246	CC634	251
TPWB10L	222	TPLR1294	225	TP272	228	TPFE421	230	CD210	234	TPS540C	240	TP1194	244	TPD115	246	CC635	251
TPCLC12	222	TPLM936	225	TP273	228	TPFE422	230	CD230	234	TPS525A	240	TP1195	244	TPD116	246	CC636	251
TPCLC34	222	TPLM1290	225	TP274	228	TPAC1225	231	CD250	234	TPMCR14	241	TP1196	244	TPD117	246	CC637	251
TPCLC1	222	TPLM937	225	TP275	228	TPAC1227	231	CD260	234	TPMCR38	241	TP1197	244	TPD118	246	CC638	251
TPWB5	222	TPLM938	225	TPCP967	228	TPAC1228	231	RSF180	234	TPMCR12	241	TP1198	244	TPD119	246	CC639	251
TPWB419	222	TPLM939	225	TPCP968	228	TPAC1226	231	CINM25	234	TPMCP14	241	TP1199	244	TPD120	246	CC640	251
TPCA461	222	TPLM940	225	TPCP969	228	TPLV1237	231	CINM50	234	TPMCP38	241	TP1200	244	TPD121	246	CSTD630	251
TPCA462	222	TPLM941	225	TPCP970	228	TPLV1236	231	CINM34	234	TPMCP12	241	TP1201	244	TPD122	246	CSTD631	251
TPJC1146	222	TPLM942	225	TPCP971	228	TPAC1233	231	CMT1	234	TPMA1130	241	TP1202	244	TPD123	246	CSTD632	251
TPJC1147	222	TPLM943	225	TPCP961	228	TPCP1234	231	CMT112	234	TPMA1129	241	TP1203	244	TPD124	246	CSTD633	251
TPCA1117	222	TPSBC41240	226	TPCP962	228	TPKP2	231	CMT2	234	TPJE1169	241	TP1204	244	TPD125	246	TPGW12	251
TPCT1105	222	TPSBC71416	226	TPCP963	228	TPBJ362	231	PATR	234	TPJE1170	241	TP1205	244	TPD126	246	TPGW14	251
TPCA1092	222	TPSBC71420	226	TPCP964	228	TPBJ363	231	CC250	234	TPJE1171	241	TP1206	244	TPD127	246	TPGW16	251
TPA502	223	TPSBC71424	226	TPCP965	228	TPBJ364	231	CC2100	234	TPNU1113	241	TP1207	244	TPD128	246	TPGW20	251
TPA503	223	TPSBC71430	226	TPCP966	228	TPBJ365	231	CC3100	234	TPNU1112	241	TP1208	244	TPD129	246	TPGW22	251
TPA504	223	TPSBC71440	226	TPCP967	228	TPBJ366	231	CT250	234	TPNU1111	241	TP1209	244	TPD130	246	TPGP954	251
TPROP	223	TPSBC71460	226	TPCP968	228	TPBJ367	231	CT2100	234	TPAD1164	241	TP1210	244	TPD131	246	TPGP955	251
TPPLP	223	TPSBC81424	226	TPCP969	228	TPBS368	231	CT3100	234	TPAD1165	241	TP1211	244	TPD132	246	TPTC22	251
TPDSC25P	223	TPSBC81432	226	TPCP970	228	TPBS370	231	TPL57	235	TPMD1131	241	TP1212	244	TPD133	246		

# ÍNDICE POR CÓDIGOS

CÓDIGO	PÁG	CÓDIGO	PÁG	CÓDIGO	PÁG	CÓDIGO	PÁG	CÓDIGO	PÁG	CÓDIGO	PÁG	CÓDIGO	PÁG	CÓDIGO	PÁG		
TPTM1675	251	TPLLC15M	254	TPETATM4	258	TPEWP12	264	EE1003	313	TPMTESTER	276	ST2418	281	ASAB21	287	ST2511	296
TPTM1676	251	TPLLC17M	254	TPETATM5	258	TPEWP34	264	EE1002	313	STMD1114	276	ST2406	281	ADAB20	287	ST2521	296
TPL154	252	TPLLC19M	254	TPETATM6	258	TPEWP1	264	EE1001	313	TPC388	276	ST2407	281	ATA819	287	ST2531	296
TPL155	252	TPLJC22EM	254	TPETATM7	258	TPWP676	264	EC1050	314	STPA1148	276	ST2415	281	STA822	287	ST2502	296
TPL156	252	TPHRK60	255	TPETFV6	258	TPWP677	264			TPEWH2	276	ST2416	281	TTA815	287	ST2512	296
TPL157	252	TPHR2K60	255	TPEEA15016	258	TPWP1065	264			TPEWH5	276	ST2260	281	TTA816	287	ST2522	296
TPPW8MHD	252	TPRS332	255	TPEEA15020	258	TPWP684	264			TPEWH15	276	ST2261	281	PCA817	287	ST2532	296
TPPW10MHD	252	TPPS1219	255	TPEEA15024	258	TPWP685	264			TPEWH20	276	ST2401	281	PSA818	287	STCEBC8	296
TPPW14MHD	252	TPPS1220	255	TPEEA17524	258	TPWP686	264			IT1P15A	276	ST2412	281	STTS1297	288	STCEBC10	296
TPPW18MHD	252	TPPS1221	255	TPEEA17528	258	TPBM693	264			IT1P20A	276	ST2413	281	STTS1298	288	STCEBC12	296
TPPW24MHD	252	TPBS1222	255	TPEEA17532	258	TPTH678	264			IT1P30A	276	ST2414	281	STAS1295	288	STCEBC14	296
TPLGP55	252	TPR1818	255	TPEEFV28	258	TPTH679	264			IT1P40A	276	STFL1708	282	STAE1812	288	STCEBC12500	296
TPLGP75	252	TPR18316	255	TPESC574	259	TPTH1063	264			IT1P50A	276	STFL1709	282	STAS1296	288	STCEBC12	296
TPLGP105	252	TPR1814	255	TPESC575	259	TPTH1064	264			STPA1149	276	STFL1710	282	STAE1813	288	STCENC10	296
TPMM1093	252	TPR18516	255	TPFP328	259	TPME1188	264			ST2272	277	STFL1711	282	STTD1299	288	STCENC12	296
TPMM1094	252	TPR1838	255	TP181	259	TPME1189	264			ST2273	277	ST2450	282	STTD1300	288	STCENC14	296
TPMM1095	252	TPR1812	255	TP225R	259	TPME1190	264			ST2274	277	ST2451	282	STAS1302	288	STCENC15200	296
TPMM1096	252	TPRS5218	255	TP225S	259	TPME1191	264			ST2275	277	ST2452	282	STAS1303	288	STCERC8	296
TPMM1097	252	TPRS5214	255	TPCONYP	260	TPMH683	264			ST2276	277	ST2453	282	STBT1304	288	STCERC10	296
TPMM1098	252	TPRS5238	255	TPYC34	260	IWP694	264			ST2277	277	TPFA780	282	STBT1305	288	STCERC12	296
TPL61045	252	TPRS5212	255	JCMB12	260	TPCB682	264			ST2278	277	ST2405	282	STAT1306	288	STCERC14	296
TPBW11	252	TPR31618	255	JCMB58	260	TPSP680	264			ST2279	277	TPFA781	282	STAT1307	288	STCERC12500	296
TPBW16	252	TPR31614	255	TPRP1178	260	TPRG1192	264			ST2280	277	TPFA782	282	STPA1301	289	STCEVC8	296
TPATSL	252	TPR31638	255	TPRP1175	260	TPRAM681	264			ST2281	277	ST2402	282	STPC1314	289	STCEVC10	296
TPATSR	252	TPR31612	255	CMM12	260	TPRH687	265			ST2282	277	ST2403	282	STPC1315	289	STCEVC12	296
TPATS	252	TPR31658	255	CMM58	260	TPRH688	265			ST2283	277	TPFA783	282	STTT1312	289	STCEVC14	296
TPT389	252	TPR31634	255	TPCP1180	260	TPRH689	265			ST2284	277	TPFA784	282	STTT1313	289	STAG2C12	296
TPT390	252	TPCG	255	TPCP1177	260	TPRH690	265			ST2285	277	ST2404	282	STTT1308	289	STAG2C14	296
TPT391	252	TPCG1	255	TPJC1213	260	TPRH691	265			ST2286	277	ST2411	282	STDA1310	289	STCPBC12	296
TPTMS8	252	TPPS1133	255	CHM12	260	TPRH692	265			ST2287	277	TPFA785	282	STDA1311	289	STCPBC14	296
TPTMS10	252	TPPMA827	256	CHM58	260	TPLLC14	266			ST2290	277	ST2400	282	STTT1309	289	STCPBC16	296
TPTMS12	252	TPPMA828	256	TPCP1179	260	TPLLC18	266			ST2291	277	STFH1816	282	STCUSB1814	289	TPF50	297
TPIJPC3	253	TPPMA829	256	TPCP1176	260	TPLLC20	266			ST2292	277	TP1033	283	STCUSB1815	289	TPF100	297
TPPCH6	253	TPPMA830	256	TPSPRP	260	TPCATSLA	266			ST2293	277	TP1032	283	STCG001	290	A012	297
TPPCH8	253	TPPMA831	256	TPAE1067	260	TPCATSL	266			ST2294	277	TP1036	283	STCG002	290	A034	297
TPP1144	253	TPPMA832	256	TPMN14	260	TP1050	266			ST2300	277	TP1038	283	STCG003	290	A01	297
TPP162	253	TPPMA833	256	TPMN516	260	TP1051	266			ST2301	277	TP1034	283	STCG004	290	A014	297
TPP163	253	TPPMA834	256	TPMN38	260	TP1052	266			ST2302	277	TP1035	283	STCG005	290	A0112	297
TPP164	253	TPPMA835	256	TPMJ1275	260	TP1054	266			ST2303	277	TP1037	283	STCG006	291	A0134	297
TPP165	253	TPPMA836	256	TPMJ1215	260	TP1055	266			ST2304	277	TP1025	283	STCG007	291	A02	297
TPPE10	253	TPPMA837	256	TPMJ1220	260	TP1060	266			ST2305	277	TP1013	283	STCG008	291	AU12	297
TPP158	253	TPPMA838	256	TPMJ1230	260	TP1061	266			ST2306	277	MTA802	283	STCG009	291	AU34	297
TPP159	253	TPPMA839	256	TPMJ5875	260	TP1062	266			ST2307	277	TP1024	283	STCG010	291	AU1	297
TPP160	253	TPPMA840	256	TPMJ5815	260	TPJT2	267			ST2308	277	STCO1654	283	STCG011	291	AU114	297
TPP161	253	TPPMA841	256	TPMJ5830	260	TPJT2EP	267			ST2309	277	STCO1655	283	STCG012	291	AU2	297
TPPMA70	253	TPPMA842	256	TPMJTV100	260	TPLF1157	267			ST2331	278	STCC1656	283	STCG014	291	AU2	297
TPJP166	253	TPPMA856	256	TPMJ58100	260	TPLF1158	267			ST2333	278	STCC1657	283	STCG015	291	TPCABT25100	297
TPJP167	253	TPPMA855	256	TPWG2L	261	TPJC11	267			ST2335	278	STCH1658	283	STCN001	292	TPCABT36150	297
TPCUT14	253	TPPMA1354	256	TPWG3B	261	TPJC416	267			ST2337	278	TP1023	284	STCN002	292	TPCABT48200	297
TPCUT18	253	TPPMA846	256	TPWG4B	261	TPPTC2W	267			ST2339	278	TP1022	284	STCN003	292	TPCABT48300	297
TPCUT24	253	TPPMA847	256	TPHS1P	261	TP188	267			ST2345	278	TP1011	284	STCN004	292	TPCABT48350	297
TPCUT30	253	TPPMA848	256	TPHS1	261	TPBTS10	267			ST2346	278	TP1014	284	STCN005	292	TPG316	297
TPCUT36	253	TPPMA849	256	TPHS2	261	TPBT10	267			ST2348	278	TP1021	284	STCN006	293	TPG318	297
TPBC18HD	253	TPPMA850	256	TPPJ1109	261	TPHBAL2000	267			ST2349	278	TP1031	284	STCN007	293	TPG319	297
TPBC24HD	253	TPPMA851	256	TPWG1	261	TPHBAL3500L	267			ST2355	278	TP1031W	284	STCN008	293	TPG320	297
TPBC30HD	253	TPPMA852	256	TPWG7	261	TPHBAL21L	267			ST2356	278	TP1030	284	STCN009	293	TPG321	297
TPBC36HD	253	TPPMA853	256	TPWG5	261	TPHBAL5000L	267			ST2357	278	TP1030W	284	STCN010	293	TPG322	297
TPPP1139	253	TPPMA854	256	TPWG8	261	TPCR454	267			ST2358	278	TP1041	284	STCN011	293	TPG323	297
TPE14516E	254	TPPMA844	256	TPME1732	261	TPTC2000M	267			ST2365	278	TP1042	284	STCN012	293	TPG324	297
TPE71612E	254	TPPMA845	256	TPME1733	261	TPTC3500M	267			ST2366	278	TP1027	284	STCN013	293	TPG325	297
TPE12916E	254	TPPMA843	256	TPME1734	261	TPTC3500L	267			ST2367	278	TP1028	284	STCN014	293	TPG326	297
TPE5834E	254	TPB12	257	TPSPR5	262	TPSM347	268			ST2368	278	TP1029	284	STCN015	293	TPC1069	297
TPEB9M	254	TPB1	257	TPSPR8	262	TPSM348	268			ST2369	278	TP1043	284	STCN016	293	TPC1070	297
TPE1011M	254	TPB112	257	TPPJ1224	262	TPSM350	268			ST2375	278	TP1015W	285	STCN017	293	CE18MR	297
TPE1213M	254	TPB2	257	TPA414	262	TPSM351	268			ST2376	278	TP1015	285	STCN018	293	CE18MR	297
TPE1617M	254	TPB212	257	TPA415	262	TPSM349	268			ST2377	278	TP1017W	285	STCN019	293	CE18MAZ	297
TPE1819M	254	TPB3	257	TPFD416	262	TPSJ354	268			ST2378	278	TP1017	285	STCN020	293	CE10M	297
TPLC111M	254	TPB4	257	TPFD417	262	TPSS353	268			ST2379	278	TP1022	285	STCN021	293	CE18M	297
TPLC5E	254	TPB5	257	TPJHJ594	262	TPBS189	268			ST2315	279	TP1020W	285	STCN022	293	TPLR479	298
TPLC5M	254	TPB6	257	TPHD1229	262	TPBS249	268			ST2316	279	TP1020W	285	STCN023	293	TPLR480	298
TPLC111E	254	TPM9P	257	TPHD1230	262	TPBS309	268			ST2317	279	TP1019W	285	STCN024	293	TPLR481	298
TPLLC14E	254	TPM9E	257	TPHD1231	262	TPBS369	268			ST2318	279	TP1019	285	STCN025	293	TPLC558	298
TPLLC516E	254	TPCHP	257	TPHD1232	262	TPBS489	268			ST2319	279	TP1016	285	STCN026	293	TPLR331	298
TPLLC38E	254	TP1063	257	TPFM1159	262	TPBS649	268			ST2320	279	TP1018W	285	STCN027	293	TPLR344	298
TPLLC12E	254	TPEM120	257	TPCR615	262	TPPR1983	302			ST2321	279	TP1018	285	STCN028	293	TPLR345	298
TPLLC916E	254	TPEM240	257	TPCR614	262	TPPR1978	303			ST2322	279	TPPOWER&UL	285	STCN029	293	TPLR346	298
TPLLC58E	254	TPEM3	257	TPTA1125	263	TPPR1975	304			ST2240	281						



## CONDICIONES DE VENTA

El pedido mínimo aceptado por la empresa es de \$5,000.00 más I.V.A.

Todo pedido a crédito deberá ser autorizado por nuestro departamento de crédito y cobranza.

No se podrá surtir ningún pedido a clientes que no tengan cédula R.F.C. vigente.

Toda liquidación deberá hacerse a través de cheques nominativos a favor de GRUPO ANBEC, S.A. de C.V. con la leyenda "para abono en cuenta del beneficiario". La empresa no se hace responsable de la liquidación de facturas que se hayan pagado de manera distinta a la descrita, todo esto considerando las disposiciones fiscales vigentes.

Para aprovechar el descuento de pronto pago, efectúe su depósito en la fecha indicada sin necesidad de esperar la visita de su representante de ventas.

Cualquier aclaración o diferencia que se pueda presentar en cantidades a la recepción de mercancía, se debe reportar al departamento de embarques en un plazo no mayor a cinco días de la recepción de material.

Cualquier cancelación o devolución genera un cargo del 20% por concepto adicional a los gastos bancarios.

Cualquier cheque devuelto genera un cargo del 20% por concepto adicional a los gastos bancarios.

Todos los precios están sujetos a cambios sin previo aviso.

Los precios de esta lista no incluyen I.V.A.

### **CUENTA PARA DEPÓSITO REFERENCIADO HSBC NO. DE CUENTA / RAP: 1682**

Favor de hacer sus pagos utilizando el número de referencia, mismo que va en cada una de sus facturas o bien, que su vendedor le pueda proporcionar.

## CUENTAS BANCARIAS:

**Banamex:** Sucursal 7000,  
cuenta: 7758403

Clabe: 002150700077584037

**Santander:** 65501398446

Clabe: 014150655013984462

**BBVA Bancomer:** 0171306774

Clabe: 012150001713067743

**Banregio:** 063-00034-001-6

Clabe: 058150630003400160

**Scotiabank Inverlat:** 21504392442

Clabe: 044150215043924420

**HSBC:** 4047045034

Clabe: 021150040470450344

**Banorte:** 0266408723

Clabe: 072150002664087235

**Banbajío:** 014598700020

Clabe: 030150900006287164

Le solicitamos que si sus depósitos son vía interbancaria indique el número de factura que está pagando.



Tels/fax:  
**(614) 492 1796,**  
**492 1576**  
**y 492 1735**

[www.anbec.com](http://www.anbec.com)  
[ventas@anbec.com](mailto:ventas@anbec.com)

